

OD1100-2

SKOPE Open Deck Chiller





SKOPE Warranty Protection

Register now for peace of mind

It's quick and simple. Take a few minutes to register your SKOPE product and enjoy more efficient support plus other warranty benefits. When registering, make sure you have your product serial number at hand.

To register online:

Visit our website at www.skope.com/warrantyprotection then complete and submit the online registration form.



Or freephone:

1800 121 535 (Australia)

0800 947 5673 (New Zealand)

Service & Support

We know you will get years of satisfaction from your new SKOPE product when you follow a few simple preventative maintenance guidelines.

Helpful information is available on our website
www.skope.com/serviceandsupport



Thank you for purchasing a SKOPE refrigeration product.

CONTENTS

1 Installation

Safety First	4
Positioning the Cabinet	5
Cabinet Location	5
Power Cord	5
Ventilation	5
Fitting the High Sign	7
Shelving	8
Adjustable Shelves	8
Bottom Shelf	8
Ticket Strips	8
Gravity Feed Shelf Slides (optional)	9
Spill Trays and Return Air Grille	10
Security Grille (optional)	11

2 Operation

Automatic Start-Up	12
Loading	12
Night Blind	13
Light & Operational Mode Switch	13
Electronic Controller	14
Introduction	14
Faceplate	14
Night Mode	15
Defrost	15
Continuous Cycle	15
Temperature Setpoint	16
Controller Reset	16
Controller Alarms	17

3 Servicing

Mains Isolation	18
Lighting	19
Sign Light	19
Cabinet Interior Light	19
Cleaning	20
Cabinet	20
Cabinet Return Air Grille	20
Night Blind	20
Spill Trays	20
Condenser Coil	21
Troubleshooting	22

1 Installation

Safety First Always observe safety precautions when using any electrical appliance. Read these instructions carefully and retain them for future reference.

- ▣ When the appliance is used by or near young children or infirm persons, close supervision is necessary, especially to ensure children do not play with it.
- ▣ Do **not** use this appliance for other than its intended use.
- ▣ Do **not** cover the grilles or block the entry or exhaust of airflow by placing objects up against the refrigeration unit.
- ▣ Do **not** probe any opening.
- ▣ Only use this appliance with the voltage specified on the cabinet rating label affixed to the refrigeration unit.
- ▣ Ensure the appliance has adequate ventilation as this is essential to economical, high performance.
- ▣ Be careful not to touch moving parts and hot surfaces.
- ▣ For your own safety and that of others, ensure that all electrical work is done by authorised personnel.
- ▣ If the power supply flexible cord becomes damaged, it must be replaced by an authorised service agent or similarly qualified person in order to avoid a hazard.
- ▣ Ensure all necessary safety precautions are observed during installation or removal of the refrigeration unit.
- ▣ The appliance is not designed to be stable while in motion. Use extreme caution when moving or transporting the cabinet.
- ▣ Do not store explosive substances such as aerosol cans with a flammable propellant in this appliance.
- ▣ Please contact SKOPE Customer Services for advice regarding disposal of this appliance.

WARNING

Always isolate the cabinet from the power supply before attempting any cleaning or maintenance.

CAUTION

Never overload the power supply, which could damage the chiller and product. See the rating label inside the cabinet for the safe power supply and current draw.

Do **not** allow liquids or any other materials to drain into the bottom of the cabinet, as this could lead to refrigeration system failure.

Positioning the Cabinet

Cabinet Location The location of the chiller may be the single most important decision that will extend its life and ensure economical, high performance.

The cabinet must **NOT** be situated where it is affected by air-conditioning air outlets, ventilation fans or air re-circulation fans, as this will compromise the airflow and product temperature in the open cabinet zone.

There must be **NO** air movement directly into the cabinet opening. Air movement will cause failure of the air curtain over the product, resulting in excessive temperature rise. Detectable air draft will adversely effect the cabinet operation. Maximum air movement across the cabinet opening must not exceed 0.2 m/s.

IMPORTANT

There must be **no** air movement directly into the cabinet opening.

We recommend that you put the chiller in the coolest place possible because it will use less power and last longer. Ensure the cabinet is positioned on a level surface to prevent the condensate tray from overflowing.

Power Cord The chiller has a flexible power cord fitted with a 3-pin plug, which exits the rear of the cabinet. Pull the power cord around so that it's not trapped before you position the chiller. The power cord must be plugged directly into a dedicated wall socket. Extension cords or multi-boxes must **NOT** be used.

IMPORTANT

Do **not** use extension cords or multi-boxes to connect the chiller to the power supply.

Ventilation Never store cardboard cartons or other items in front or rear of the refrigeration unit. The ventilation slots in the front and rear of the cabinet must be kept clear at all times.

For efficient operation of the chiller, it is essential that adequate ventilation clearance be provided around the cabinet (see diagram over page). Normal operating conditions should not exceed 25°C at 60% RH (Climatic Class 3). It is critical that the hot refrigeration exhaust air is not restricted and that it can easily flow up and away from the cabinet. Restricted ventilation increases power consumption.

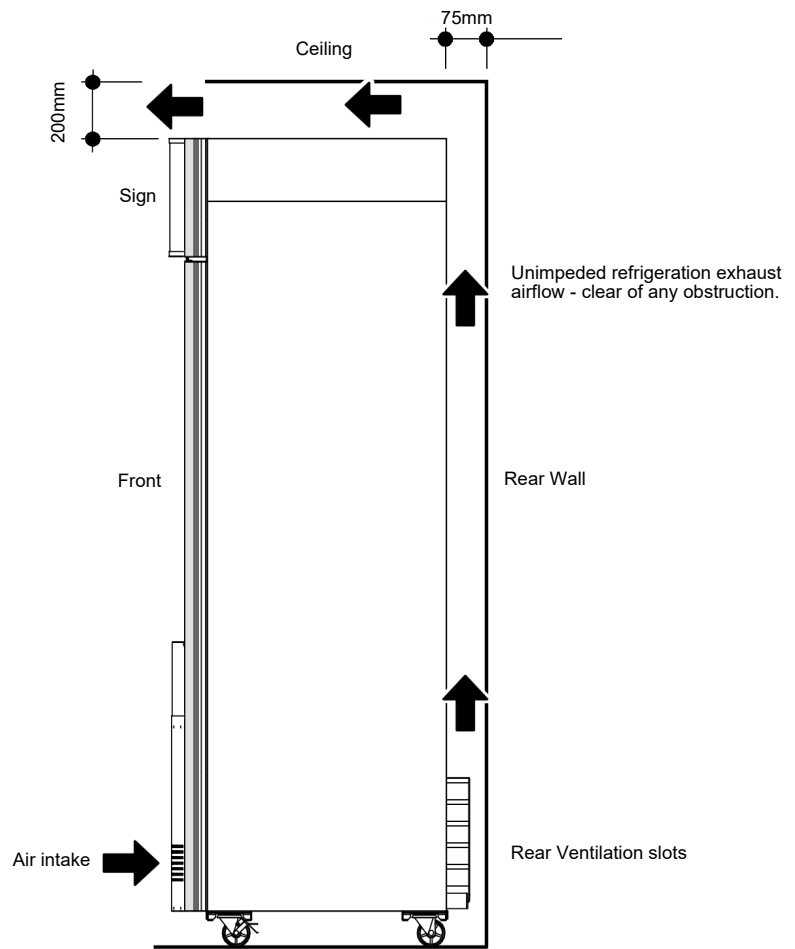

IMPORTANT

The minimum clearance behind the cabinet must be at least 75mm. The minimum clearance above the cabinet must be at least 200mm. The cabinet should preferably have 60mm clearance on both sides.

Fitting the High Sign

For transit purposes the OD1100-2 High Sign model has the high sign assembly packed separately inside the cabinet. The OD1100-2 Low Sign model has the sign assembly already fitted to the cabinet and requires no additional assembly.

To fit the shelves

1. Unpack the sign assembly. There should be four pieces - two identical side panels, one rear panel and the sign assembly.

2. Loosen the four retaining screws on the roof of the cabinet and fit each sign side panel over the screws. Slide the sign side panels forward, flush with the front of the cabinet and tighten all four retaining screws.

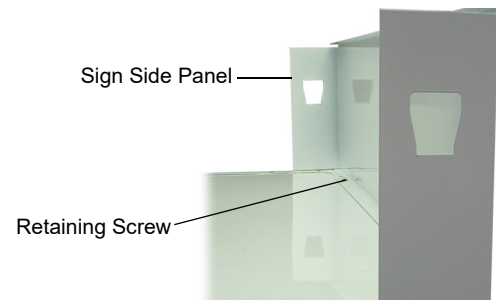

3. Fit the sign rear panel across the back of the sign side panels by clipping each end tag into the retaining slot in the side panels.

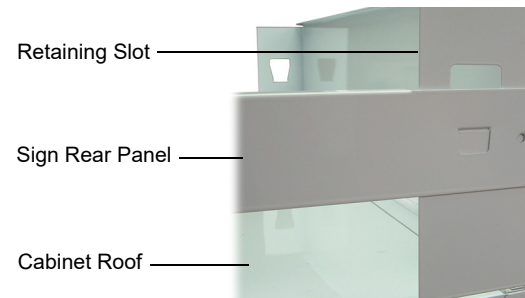

4. Attach the high sign assembly onto the cabinet by clipping the top of the sign into the retaining slots at the top of both side panels and then locating the bottom of the sign over both the bottom keyhole screws.

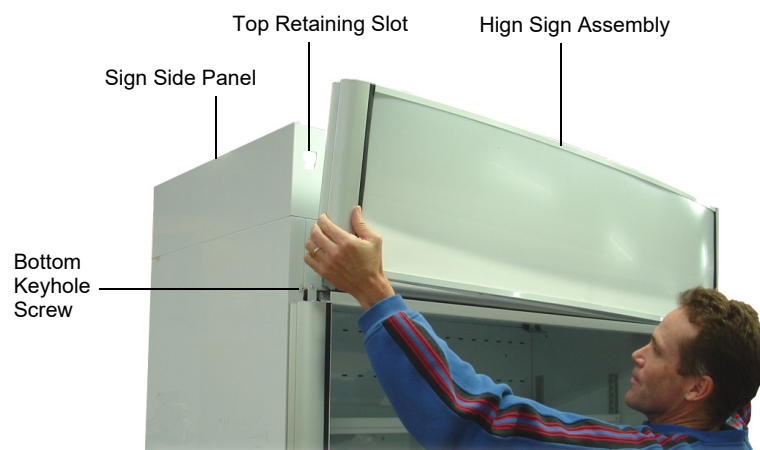

5. Pull the sign assembly down to ensure it is securely attached.
6. To remove the sign assembly from the cabinet, lift the sign up to disengage from the sign sides and then pull the sign assembly away from the cabinet.

Shelving

The chiller is supplied with the following standard shelving items packed inside the cabinet:

- 2 adjustable height top shelves (shallow depth)
- 2 adjustable height middle shelves (medium depth)
- 1 fixed bottom shelf (deep - supplied fitted)
- 5 ticket strips
- 16 shelf clips

Adjustable Shelves

The four top shelves can be positioned at different heights to suit various products and are each held in place with four shelf support clips. The two top shelves are shallow depth and the two middle shelves are medium depth.

The four adjustable shelves are designed to be positioned either flat or angled down to accommodate the gravity feed shelf slides and dividers.

To fit the shelves

1. Unpack all the shelving items from inside the cabinet.

2. Establish the desired position for each of the shelves, based on the height of the product intended to go on each shelf.

3. Fit four shelf clips in each of the shelf support strips. To angle the shelves, fit the front clips two holes lower than the back clips.

4. Fit the four shelves, beginning with the bottom shelf working up to the top shelf.

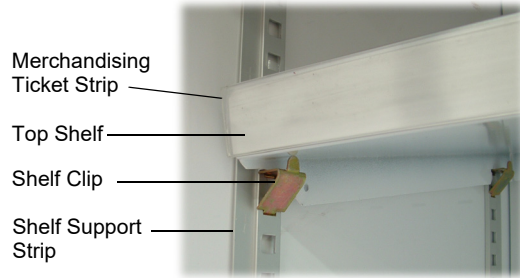

Bottom Shelf

The bottom shelf is deeper than the adjustable shelves and is fixed at an angle to the floor of the cabinet.

Ticket Strips

The merchandising ticket strips, which go on the front of all the shelves, are intended for inserting advertising material.

Gravity Feed Shelf Slides (optional)

When the adjustable shelves are positioned angled down, optional gravity feed shelf slides and dividers can be fitted to the shelves. The angle ensures that cold product slides to the front of the shelf.

The shelf slides are different depths to match the different depths of the shelves. The two top shelves are shallow depth, the two middle shelves are medium depth and the bottom fixed shelf is deep depth.

To fit the gravity shelf slides and dividers

1. Place the gravity slides onto the corresponding shelf, with the smooth side facing up and the upstand towards the front.

2. Clip the dividers into the gravity shelf slides, as per the installation instructions printed on the side of each divider. The spacing between the dividers depends on the size and quantity of product.

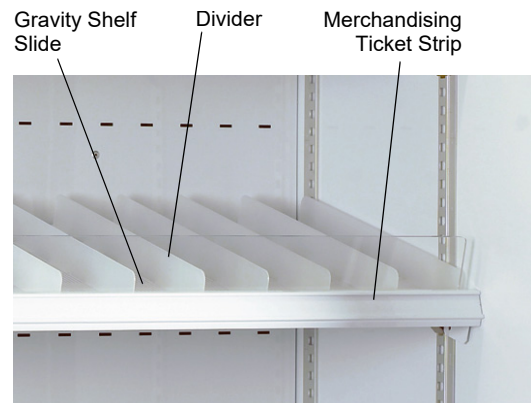

Spill Trays and Return Air Grille

Two spill trays aid in the capture of any spilt liquid, and the return air grille prevents items falling from the cabinet interior into the refrigeration unit.

The spill trays fit under the bottom shelf with the angled edge facing the front. The return air grille sits in front of the spill trays and on a bracket on the inside of the front panel.

The return air grille and spill trays can be removed for ease of cleaning (see page 20).

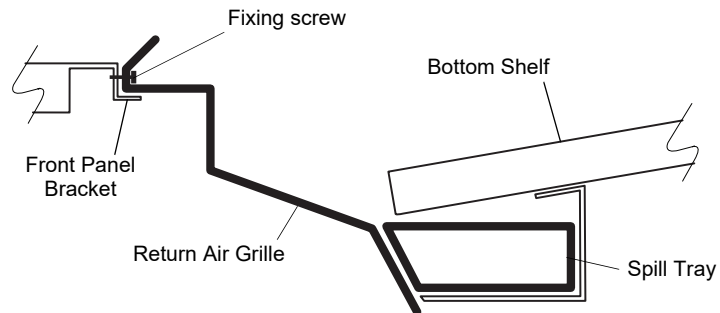

Spill tray and return air grille configuration (section viewed from side)



Spill trays



Return air grille

Security Grille (optional)

For security purposes an optional lockable security grille is available. The security grille fits in the front opening of the cabinet and is locked by two keyed security bolts. For convenience both locks use the same key.

To fit the optional security grille

1. Position the security grille (with the tags at the top and locks on the sides) into the top of the cabinet opening.

2. Manoeuvre the security grille into position so that both tags at the top of the grille locate into the slots under the sign assembly.



3. Position the sides of the grille to align both the security lock bolts with the holes in the sides of the cabinet.

4. Engage both the lock bolts and lock with the security key (see below).

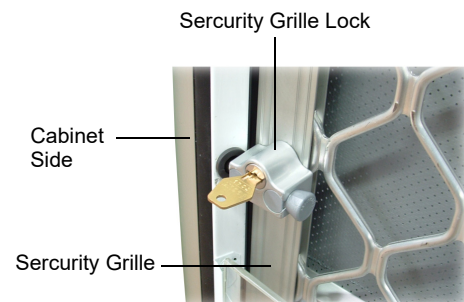

5. Removing the security grille is a reversal of the above fitting instructions.
-

2 Operation

Automatic Start-Up

After the chiller has been positioned in a suitable place, plug it in and check the following activity:

Item	Activity
Refrigeration Unit	The condenser and evaporator fans operate continuously from the time the cabinet is plugged in. The compressor will start after approximately one minute. The compressor will switch off when the cabinet internal temperature reaches approximately +1.5°C, and on again at approximately +4°C.
Electronic Controller	When the cabinet is connected to the power supply, the electronic controller will display the current cabinet temperature. The compressor LED will indicate the compressor is operating and the evaporator fan LED will normally come on within 2 minutes (see page 14 for controller display).
Cabinet Lighting	The illuminated sign and cabinet interior light will both go on when the cabinet is plugged in. The cabinet lighting should be switched on or off as the night blind is raised or lowered (See "Light & Operational Mode Switch" on page 13.)

Loading

Let the chiller run for 30 minutes before loading it with product. When loading the cabinet shelves with product:

- Ensure all shelves are securely fitted.
- Allow air space around all packages etc. for even cooling and efficient operation of the chiller.
- Leave an air space of at least 50mm (2") above packages etc. on the top shelf.
- Do not allow products to overhang the front of the shelves, as this will effect the air flow.
- Do not exceed a maximum loading of 20kg per shelf.
- Remove some product if the shelves are flexing or bending.
- Do not load product over the return air grille.

Night Blind

The chiller is fitted with an energy saving night blind. The blind, located behind the sign, may be pulled down outside of trading hours to save energy. When lowering or raising the blind, the light switch should be used to switch between light or element operation (see “Light & Operational Mode Switch” below).

To lower the blind, pull down the centre handle. To keep the blind down, locate the bottom of the blind into the captive brackets on each side of the cabinet opening. When raising the blind, hold the centre handle to prevent the torsion mechanism from snapping the blind up.

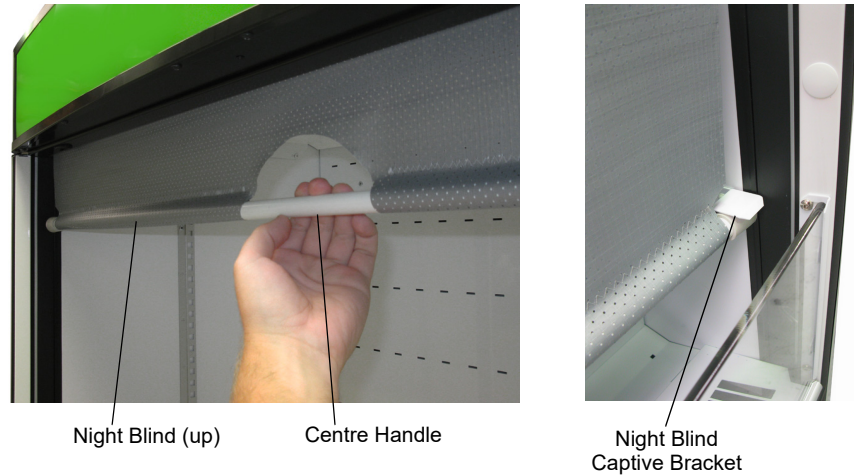

Light & Operational Mode Switch

The chiller is fitted with a light switch. The light switch also controls the element and switches the chiller between normal and night modes.

The light switch is located above the night blind. It simultaneously switches the light on, turns element off and enters the chiller into normal mode, or vice versa (light off, element on and chiller into night mode). It should be used to switch between the light and element when the night blind is raised or lowered.

Night blind raised

The light should be switched on (element switched off) when the night blind is up.

Night blind lowered

The light should be switched off (element switched on) when the night blind is lowered.



Electronic Controller

Introduction The electronic controller controls the chiller and signals temperature alarms. The preset temperature setting controls the product temperature between 0°C and 5°C. The electronic controller is pre-programmed and usually requires no initial setup or additional programming. SKOPE does not recommend that the settings be changed unless necessary.

Faceplate Because the electronic controller plays such an important role, it's helpful to know the parts of the faceplate you may use.

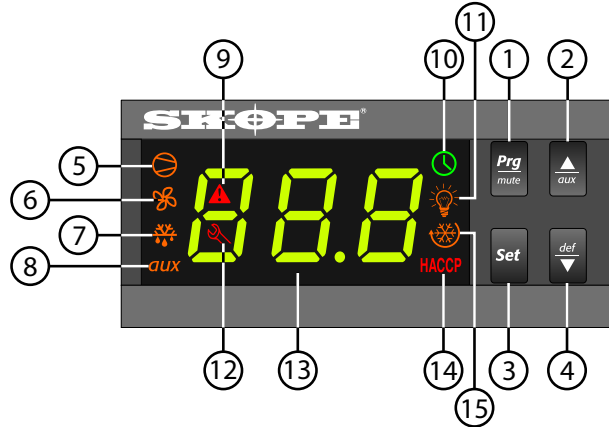

No.	Item	Description
1		MUTE/Prg: Mutes the audible controller alarm. Also used for programming.
2		AUX/UP: Used for programming.
3		SET: Used for programming.
4		MANUAL DEFROST/DOWN: Press and hold to initiate a manual defrost cycle. Also used for programming.
5		COMPRESSOR: ON when the compressor and condenser fan starts. Flashes when activation of the compressor is temporarily delayed.
6		FAN: Shows when fan is operational.
7		DEFROST: ON when the defrost is activated. Flashes when the activation of the defrost is temporarily delayed due to procedures in progress.
8		AUX: n.a.
9		ALARM: Flashes in the event of alarms.
10		CLOCK: On when real time clock is enabled.
11		LIGHT: On when the cabinet lighting is activated.
12		SERVICE: Flashes in the event of malfunctions.
13		DISPLAY: Shows the cabinet temperature during normal operating mode.
14		HACCP: n.a.
15		CONTINUOUS CYCLE: Flashes when the continuous cycle is activated.

Night Mode The chiller enters into Night Mode when the lights are switched off (see “Light & Operational Mode Switch” on page 13). During night mode the chiller enters a power saving mode with the cabinet lights off and the temperature setting automatically alters to maintain an optimum temperature. The controller will display ‘nHt’ when in night mode. Ensure the night blind is lowered while the chiller is in night mode.

IMPORTANT

The night blind must be lowered while the chiller is in night mode.

The chiller will exit night mode and enter normal operation mode when the lights are switched on. The night blind must be fully raised while the chiller is in normal operation mode.

Defrost To ensure efficient operation, the electronic controller forces a defrost cycle when required. During a defrost cycle, the compressor stops, **DEF** and the ❄️ will display on the electronic controller faceplate. The cabinet will resume normal operation once the defrost cycle has finished. A manual defrost can also be initiated by pressing and holding the $\frac{def}{\nabla}$ button.

Continuous Cycle The continuous cycle can be used to pull down the temperature of product inside the cabinet quickly. During a continuous cool down the compressor runs continuously for a set time.

To start a continuous cycle

1. While the cabinet is switched on and running, press and hold the $\frac{aux}{\blacktriangle}$ and $\frac{def}{\blacktriangledown}$ buttons for five seconds.

The display shows **ccb** when the continuous cycle begins. The ❄️ symbol flashes during a continuous cycle.

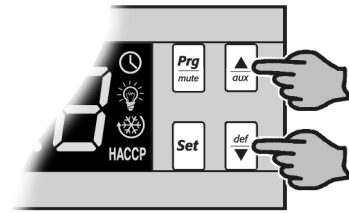

To stop a continuous cycle

1. The electronic controller will automatically stop the continuous cycle after a period of time.

The continuous cycle can be stopped by pressing and holding the $\frac{aux}{\blacktriangle}$ and $\frac{def}{\blacktriangledown}$ buttons for five seconds. The display shows **ccE** when the continuous cycle is stopped.

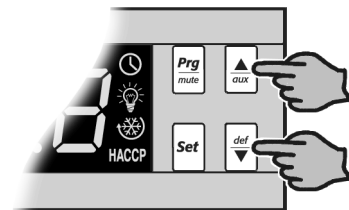

Temperature Setpoint

The chiller is manufactured with a pre-set control temperature set point of 1.5°C. If this set point does not match your required storage temperature it is recommended that you change the set point accordingly. The set point can be adjusted between 0.5°C and 4.5°C.

To view and adjust the temperature setpoint

1. To view the setpoint: press and hold the **Set** key for 2 seconds, until the setpoint value flashes

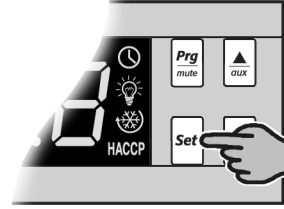

2. To adjust the setpoint: press either the $\frac{\Delta}{aux}$ and $\frac{def}{\nabla}$ keys to display the required setpoint value.

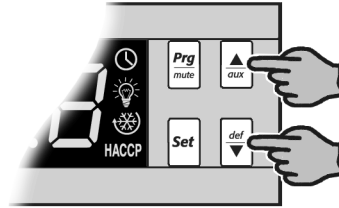

3. Press the **Set** key again to memorise the new setpoint value. If this is not done within 60 seconds, changes will be lost and you will need to repeat the above procedure.

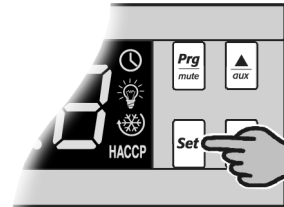

Controller Reset

To delete program modifications, change the operating mode, reset the controller to SKOPE default program or when a replacement controller is being fitted, a 'Controller Reset' must be performed.

To reset the controller

1. Isolate the chiller from the power supply (see "Mains Isolation" on page 18).

2. Press and hold the $\frac{Prg}{mute}$ key while switching the isolation switch on. After a few seconds the controller is reset and program mode '**bn0**' is displayed. The controller must never be left in program mode '**bn0**' as failure will occur.

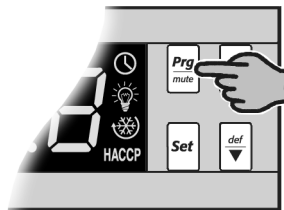



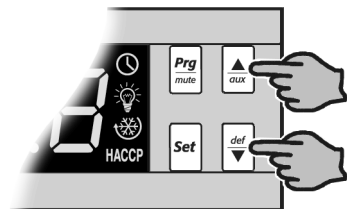



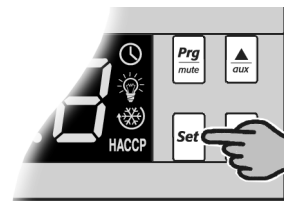



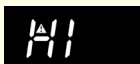



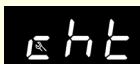

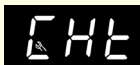





3. Press the $\frac{\Delta}{aux}$ or $\frac{def}{\nabla}$ keys to select **bn1** (standard, suitable for perishable product), **bn2** (non-perishable product) or **bn3** (remote refrigeration system) for SKOPE default programs.

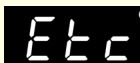

4. Immediately press the **Set** key to confirm the preferred program. If not confirmed within 60 seconds the chiller will remain in program mode '**bn0**' (and cause failure). If this occurs, repeat the above procedure.



Controller Alarms

Code	Display	Buzzer	Alarm Description	Action
	 Flashing	on	Product HIGH temperature alarm (auto reset)	<ol style="list-style-type: none"> 1. Check the cabinet product loading to ensure ventilation slots are not blocked and that product does not overhang the shelves. 2. Ensure the cabinet is installed with good refrigeration unit ventilation. 3. If immediate alarm recovery is required - unplug the cabinet from the power supply for 1 minute, then reconnect to power supply. <p>If alarm persists, contact SKOPE.</p>
	 Flashing	on	Product LOW temperature alarm (auto reset)	
	 Flashing	off	Refrigeration system high temperature pre-warning (auto reset)	<ol style="list-style-type: none"> 1. Check refrigeration ventilation. Ensure clear airpath at the top and front of the cabinet (to extract hot air). A minimum of 200mm clear space is required above and in front of the refrigeration unit. 2. Ensure the cabinet is installed in a suitable environment. 3. To reset the 'CHT' alarm - unplug the cabinet from the power supply for 1 minute, then reconnect to power supply. <p>If alarm persists, contact SKOPE.</p>
	 Flashing	on	Refrigeration system high temperature shutdown (manual reset)	
	 Flashing	off	Ambient probe fault (also flashes 'rE')	<p>To reset alarm - unplug the cabinet from the power supply for 1 minute, then reconnect to power supply.</p> <p>If alarm persists, contact SKOPE.</p>
	 Flashing	off	Evaporator probe fault	
	 Flashing	off	Condenser probe fault	
	None	off	Defrost over-time limit	
	 Flashing	off	Real-time clock fault	
	 Flashing	off	Controller E prom error	
	 Flashing	off	Controller E prom error	
	None	-	Start defrost request	None
	None	-	End defrost request	

3 Servicing

Mains Isolation

The chiller should be isolated from the power supply before attempting **any** maintenance or servicing. Use the isolation switch to turn off electrics to the cabinet and refrigeration unit without unplugging the cabinet from the wall.

To isolate the electrics

1. Remove the fixing screw from the return air grille (see page 10) and lift the grille up and out from the cabinet front opening.



2. Remove the front panel by locating and unclipping the two bottom brackets (can be felt at the bottom of the front panel), and lift the front panel up and off the cabinet.



3. Switch off (O) the power at the isolation switch on the LH side of the refrigeration unit compartment, and unplug the IEC plug.



4. To reassemble, reconnect the mains isolation plug and switch on, locate the front panel onto the support brackets at the bottom of the cabinet opening and push the bottom brackets into the bottom of the cabinet to lock in place, and refit the return air grille.

Lighting

Sign Light The illuminated sign is fitted with one 20 Watt T7 LED tube (Ø19mm × 1150mm).

To replace the sign light tube

1. Remove the front panel and isolate the chiller from the mains power supply (see page 18).
2. Remove the sign assembly from the cabinet by lifting the sign up to disengage from the cabinet and then pulling forward to separate the sign from the cabinet.
3. Rotate the faulty light tube until the pin position allows withdrawal, and lift the tube up to remove.

4. Set the replacement tube rotating end caps to 90° so that light will be directed out from the sign.

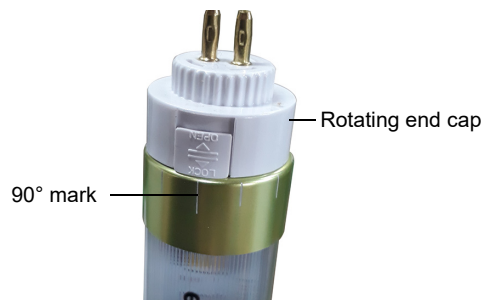

5. Fit the replacement tube with the power end (the end with the writing) at the LH side of the cabinet.



6. Reassemble and test for correct operation.
-

Cabinet Interior Light The cabinet interior is fitted with one 24 Watt T7 light tube (Ø19mm x 1150mm).

To replace the cabinet interior light tube

1. Remove the front panel and isolate the chiller from the mains power supply (see page 18).
 2. Reach inside the cabinet and remove the light diffuser from underneath the sign assembly by compressing the front section of the diffuser until it disengages from the aluminium housing.
 3. Rotate the faulty light tube until the pin position allows withdrawal, and remove.
 4. Check that the replacement tube rotating end caps are set to 0°, so that when fitted light will be directed down towards the shelves.
 5. Fit the replacement tube with the power end (the end with the writing) at the LH side of the cabinet.
 6. Reassemble and test for correct operation.
-

Cleaning

Cabinet Periodically wipe the inside and outside of the chiller with a damp cloth, taking care to keep moisture away from electrical parts. As with any maintenance, ensure the chiller is isolated from the power supply before cleaning (see page 18).

CAUTION
Do **not** wash any solvents down into the refrigeration system, as this could lead to refrigeration failure.

Cabinet Return Air Grille The cabinet return air grille can be lifted from the cabinet for cleaning. If any foreign objects fall down the air slots ensure the chiller is isolated from the mains power supply before reaching down to retrieve the object/s.

CAUTION
Take care not to allow anything to drop into this area, as retrieval would be difficult.

Night Blind Lower the night blind and wipe the front and back with a damp cloth. Do not use hot water as this may damage the blind material.

CAUTION
Do **not** clean the night blind with hot water.

Spill Trays The two spill trays are located in the bottom of the cabinet underneath the bottom shelf (see below). The trays can be removed for ease of cleaning.

To remove the spill trays

1. Remove the fixing screw from the return air grille (see page 10) and lift the grille up and out from the cabinet front opening.



2. The spill trays can now be lifted from the chiller.



3. When refitting, ensure the return air grille and both spill trays are in place and fitted correctly. See page 9 for correct configuration.
-

Condenser Coil To ensure trouble-free performance, the condenser coil must be kept clean. We strongly urge monthly cleaning with a soft brush to remove dust and fluff. A more thorough cleaning is required by qualified service personnel every six months. The condenser coil **must** be kept clean for efficient and reliable operation.

WARNING

Isolate the chiller from the power supply before cleaning the condenser coil.

To clean the condenser coil

1. Remove the front panel and isolate the chiller from the power supply (see page 18).

2. Brush the condenser coil with a soft brush



3. Reconnect the chiller to the power supply and refit the front panel.

Troubleshooting

For questions about the EMS advanced controller, see page 14. For problems with the cabinet and refrigeration unit, use the following table.

Problem	Possible Cause	Suggestions
<ul style="list-style-type: none"> • Chiller not operating • No controller display 	<ul style="list-style-type: none"> • Loss of power supply • Isolating switch turned off 	<ul style="list-style-type: none"> • Check mains power supply. • Check isolating switch (see page 18).
<ul style="list-style-type: none"> • Cabinet lights not on 	<ul style="list-style-type: none"> • Light switched off. • Failed light tube • Blown cabinet fuse 	<ul style="list-style-type: none"> • Switch the light on (see page 13). • Replace the light tube (see page 19). • Arrange a service call.
<ul style="list-style-type: none"> • Power consumption is higher than expected 	<ul style="list-style-type: none"> • Unit operating too hot 	<ul style="list-style-type: none"> • Clean the condenser coil (see page 21). • Ensure the cabinet has good ventilation around the refrigeration unit (see page 5). • Ensure the cabinet is installed in a cool location. • Ensure product is not blocking airflow slots. Check for blockage on the return air grille (see page 10).
<ul style="list-style-type: none"> • Product is too warm 	<ul style="list-style-type: none"> • Restricted airflow to cabinet 	<ul style="list-style-type: none"> • Ensure product is not blocking airflow slots. Check for blockage on the return air grille (see page 10). • Ensure there is space around individual product pieces.
<ul style="list-style-type: none"> • Warm cabinet temperatures • Compressor operating for long periods (more than 1 hour) 	<ul style="list-style-type: none"> • Blocked condenser • Poor ventilation around refrigeration unit 	<ul style="list-style-type: none"> • Clean the condenser coil (see page 21). • Ensure the cabinet has good ventilation around the refrigeration unit (see page 5).

SKOPE Industries Limited

A.B.N. 73 374 418 306

AU: 1800 121 535

NZ: 0800 947 5673

skope@skope.com

www.skope.com

Trademark Infringement

The SKOPE and Centaur trademarks on this product are infringed if the owner, for the time being, does any of the following:

- Applies the trade mark to the product after their state, condition, get-up or packaging has been altered in any manner
- Alters, removes (including part removal) or obliterates (including part obliteration) the trade mark on the product
- Applies any other trade mark to the product
- Adds to the product any written material that is likely to damage the reputation of the trade mark

Notice of the above contractual obligations passes to:

- Successors or assignees of the buyer
- Future owners of the product

SKOPE OD1100-2
Open Deck Chiller
User Manual
MAN10617
Rev. 2.0 Sep. 2017

© 2013 SKOPE Industries Limited. All rights reserved.

SKOPE Industries Limited reserve the right to alter specifications without notice.

SKOPE® is a registered trademark of SKOPE Industries Limited.