





Model Code: HKO400

Included Accessories

 ICC6 x 2	 HKO52		

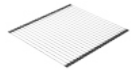
Optional Accessories

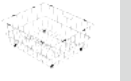
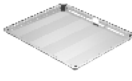
 HKO39	 HKO44	 HKO46	 HKO48
 HKO49			

Dimensions

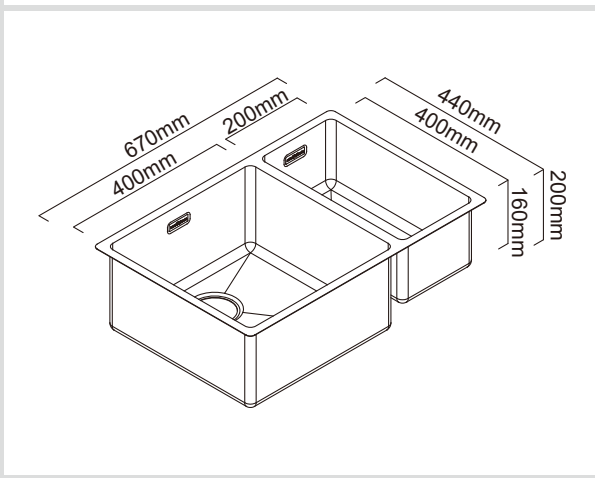

Specifications

Description	Double Bowl, Undermount/Inset Sink
Overall Sink Size	670mm x 440mm x 200mm deep
Bowl Dimensions	400mm x 400mm x 200mm deep 200mm x 400mm x 160mm deep
Drainer Length	N/A
Technic	Fabrication
Material	Stainless steel SUS304

Installation

Fixings	Inset clips supplied
Template	N/A
Min Cabinet Size	800mm
Waste Holes	2 x 90mm round Compatible with waste disposal

SURFACE FINISH



WASTE KIT

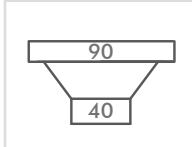

MATERIAL



INSTALLATION OPTIONS

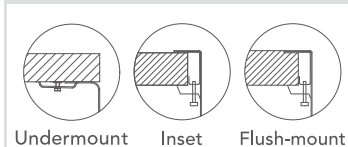

PROFILE

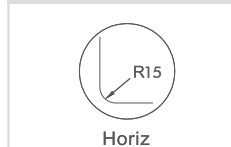

Plumbing

Waste Fittings	2 x (90mm x 1 1/2") basket wastes included
Overflow	Included

Packaging

Carton Type	Eco-packaging & individual carton
Gross Weight	12Kg
Carton Size	740mm x 290mm x 535mm
Pack QTY	1

Burns & Ferrall is pleased to offer a limited 25-year warranty on all Zomodo sinks used in normal domestic installations. Burns & Ferrall warrants its sinks to be free from all manufacturing defects in material and workmanship. Burns & Ferrall warrants Zomodo waste kits, basket sieves and overflow assembly to be free from manufacturing defects for a period of one (1) year. Burns & Ferrall warrants Zomodo taps' stainless steel casing to be free from manufacturing defects for a period of twenty-five (25) years, the supply hose and inner cartridge for a period of five (5) years, and the inner parts including the aerator and O-ring for a period of one (1) year from the date of purchase. Burns & Ferrall will repair or replace (at Burns & Ferrall's discretion), at no charge, excluding labour, any product supplied by Burns & Ferrall that is proven to be defective under normal use.

Please visit www.zomodo.co.nz/warranty for full terms & conditions.

www.zomodo.co.nz