

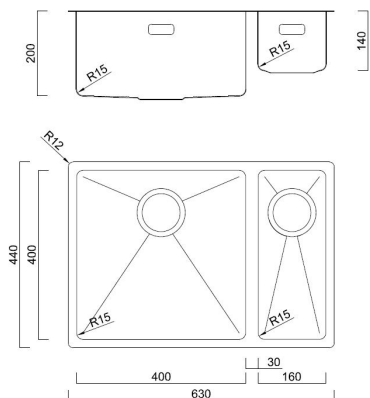

BDM630L Burns & Ferrall Left Hand Main bowl



Dimensions



Specifications

Description	Double Bowl - Left Hand
Overall Sink Size	630mm x 440mm x 200mm deep
Bowl Dimensions 1	400mm x 400mm x 200mm deep
Bowl Dimensions 2	160mm x 400mm x 140mm deep
Drainer Length	N/A
Manufacture	Fabricated
Material	1.2mm Stainless steel 304

Installation

Fixings	Topmount clips supplied
Template	N/A
Min Cabinet Size	690mm (allows 30mm on either side for hinges)
Waste Holes	2 x 90mm round Compatible with waste disposal

Plumbing

Waste Fittings	2 x 90mm basket wastes included
Overflow	2x Designer Badge style, included Compliant at 15L/Min (250ml/sec)

Replacement Parts

- Full Waste Kit + O/Flow: BFDWK
- Plug/Basket: BFDBASKET
- Top Mount Clips: ICC6B
- Overflow Badge: BFDOFF

SURFACE FINISH



Microbrush

WASTE KIT

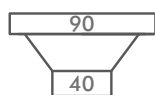

MATERIAL



304
Stainless Steel

INSTALLATION OPTIONS



Undermount Topmount Flushmount

PROFILE



Optional Accessories



Reward Hospitality is pleased to offer a limited 25-year warranty on all Stainless Steel sinks used in normal domestic installations. Reward Hospitality warrants its sinks to be free from all manufacturing defects in material and workmanship. Reward Hospitality warrants the waste kits, basket sieves and overflow assembly to be free from manufacturing defects for a period of one (1) year. Reward Hospitality warrants taps to be free from manufacturing defects for a period of five (5) years, the supply hose and inner cartridge for a period of five (5) years, and the inner parts including the aerator and O-ring for a period of one (1) year from the date of purchase. Reward Hospitality will repair or replace (at Reward Hospitality's discretion), at no charge, excluding labour, any product supplied by Reward Hospitality that is proven to be defective under normal use.