

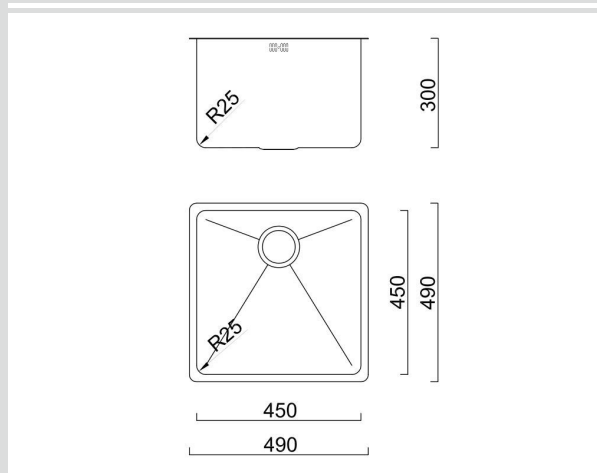

BFL490R25-300 Burns & Ferrall Laundry bowl



Dimensions



Specifications

Description	Single Bowl
Overall Sink Size	490mm x 490mm x 300mm deep
Bowl Dimensions	450mm x 450mm x 300mm deep
Drainer Length	N/A
Manufacture	Fabricated
Material	1.2mm Stainless steel 304

Installation

Fixings	Screw down Tags
Template	N/A
Min Cabinet Size	510mm (allows 30mm on either side for hinges)
Waste Holes	1 x 90mm round Compatible with waste disposal

Plumbing

Waste Fittings	1 x 50mm waste + plug
Overflow	N/A

Replacement Parts

Full Waste Kit :	REGWK
Plug/Basket:	REGBASKET
Top Mount Clips:	N/A
Overflow Badge:	N/A

SURFACE FINISH



WASTE KIT

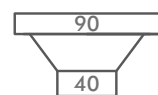

MATERIAL

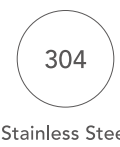



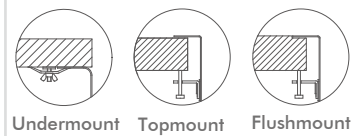



INSTALLATION OPTIONS



PROFILE



Optional Accessories

					 WK-ODB
	 BFDDB			 BFLD	 SPAZIO
 CONOIL	 SSPOLISH				

Reward Hospitality is pleased to offer a limited 25-year warranty on all Stainless Steel sinks used in normal domestic installations. Reward Hospitality warrants its sinks to be free from all manufacturing defects in material and workmanship. Reward Hospitality warrants the waste kits, basket sieves and overflow assembly to be free from manufacturing defects for a period of one (1) year. Reward Hospitality warrants taps to be free from manufacturing defects for a period of five (5) years, the supply hose and inner cartridge for a period of five (5) years, and the inner parts including the aerator and O-ring for a period of one (1) year from the date of purchase. Reward Hospitality will repair or replace (at Reward Hospitality's discretion), at no charge, excluding labour, any product supplied by Reward Hospitality that is proven to be defective under normal use.