

BDM540 Burns & Ferrall Single bowl

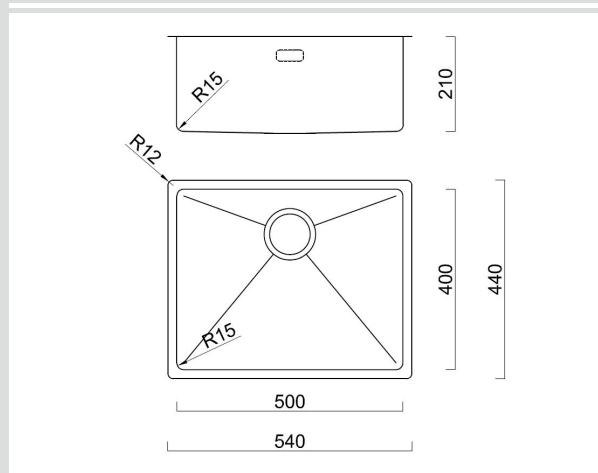

Dimensions



Specifications

Description	Single Bowl
Overall Sink Size	540mm x 440mm x 210mm deep
Bowl Dimensions	500mm x 400mm x 210mm deep
Drainer Length	N/A
Manufacture	Fabricated
Material	1.2mm Stainless steel 304

Installation

Fixings	Topmount clips supplied
Template	N/A
Min Cabinet Size	560mm (allows 30mm on either side for hinges)
Waste Holes	1 x 90mm round Compatible with waste disposal

Plumbing

Waste Fittings	1 x 90mm basket wastes included
Overflow	Designer Badge style, included Compliant at 15L/Min (250ml/sec)

Replacement Parts

Full Waste Kit + O/Flow:	BFDWK
Plug/Basket:	BFDBASKET
Top Mount Clips:	ICC6B
Overflow Badge:	BFDOFF

SURFACE FINISH



WASTE KIT

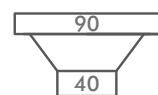

MATERIAL



INSTALLATION OPTIONS

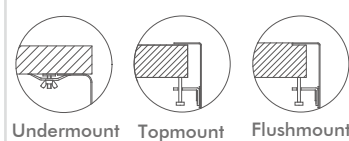

PROFILE



Optional Accessories

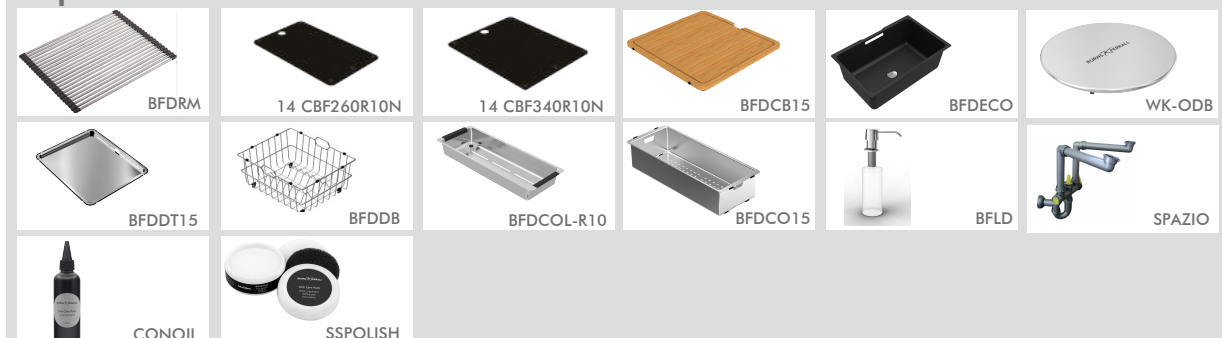

Reward Hospitality is pleased to offer a limited 25-year warranty on all Stainless Steel sinks used in normal domestic installations. Reward Hospitality warrants its sinks to be free from all manufacturing defects in material and workmanship. Reward Hospitality warrants the waste kits, basket sieves and overflow assembly to be free from manufacturing defects for a period of one (1) year. Reward Hospitality warrants taps to be free from manufacturing defects for a period of five (5) years, the supply hose and inner cartridge for a period of five (5) years, and the inner parts including the aerator and O-ring for a period of one (1) year from the date of purchase. Reward Hospitality will repair or replace (at Reward Hospitality's discretion), at no charge, excluding labour, any product supplied by Reward Hospitality that is proven to be defective under normal use.