

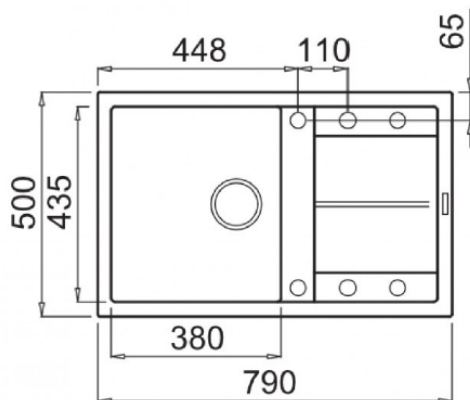

ELGU300-40 Elleci Granite Single bowl + Drainer

Dimensions



Specifications

Description	Single Bowl + Drainer (REVERSIBLE)
Overall Sink Size	790mm x 500mm x 240mm deep
Bowl Dimensions	380mm x 435mm x 200mm deep
Drainer Length	390mm
Manufacture	Molded & Fired
Material	Composite Granite (80%) Resin (20%)

Installation

Fixings	Topmount clips supplied
Template	N/A
Min Cabinet Size	460mm (allows 30mm on either side for hinges)
Waste Holes	1 x 90mm round

Plumbing

Waste Fittings	1 x 90mm basket wastes included
Overflow	40mm dia chrome included Compliant at 15L/Min (250ml/sec)

Replacement Parts

Full Waste Kit + O/Flow:	ELGMQWKKIT
Plug/Basket:	ELQBASKET
Top Mount Clips Rectangle:	N/A
Overflow Badge:	N/A

SURFACE FINISH



Honed Black

WASTE KIT

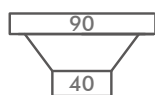

MATERIAL



INSTALLATION OPTIONS







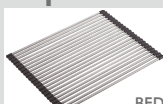

Topmount

PROFILE



Optional Accessories

 BFDRM				 WK-ODB
			 BFLD	 SPAZIO
 CONOIL	 SSPOLISH			

Reward Hospitality is pleased to offer a limited 25-year warranty on all Stainless Steel sinks used in normal domestic installations. Reward Hospitality warrants its sinks to be free from all manufacturing defects in material and workmanship. Reward Hospitality warrants the waste kits, basket sieves and overflow assembly to be free from manufacturing defects for a period of one (1) year. Reward Hospitality warrants taps to be free from manufacturing defects for a period of five (5) years, the supply hose and inner cartridge for a period of five (5) years, and the inner parts including the aerator and O-ring for a period of one (1) year from the date of purchase. Reward Hospitality will repair or replace (at Reward Hospitality's discretion), at no charge, excluding labour, any product supplied by Reward Hospitality that is proven to be defective under normal use.