

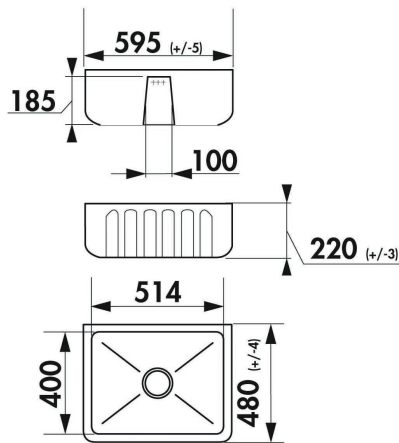

## LOUIS-I Chambord Butler Sink

**Chambord**  
FRANCE

### Dimensions



### Specifications

Description	Single Bowl - Butler Sink
Overall Sink Size	595mm x 480mm x 220mm deep
Bowl Dimensions	514mm x 400mm x 220mm deep
Drainer Length	N/A
Manufacture	Hand Cast hardened at 1200 degrees
Material	Fire Clay

### Installation

Fixings	N/A
Template	N/A
Min Cabinet Size	600mm
Waste Holes	1 x 90mm round NOT Compatible with waste disposal

### Plumbing

Waste Fittings	1 x 90mm basket wastes included
Overflow	Chrome 40mm round style, included Compliant at 15L/Min (250ml/sec)

### Replacement Parts

Full Waste Kit + O/Flow:	LOUISWK
Plug/Basket:	CHAM-BW
Top Mount Clips Rectangle:	N/A
Overflow Badge:	N/A

#### SURFACE FINISH



Glazed  
Fire Clay

#### WASTE KIT

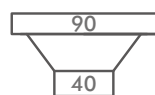

#### MATERIAL

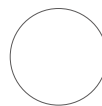







Fire Clay

#### PROFILE



## Optional Accessories

				 BFDECO	 WK-ODB
	 BFDDB			 BFLD	 SPAZIO
	 SSPOLISH				

Reward Hospitality is pleased to offer a limited 25-year warranty on all Stainless Steel sinks used in normal domestic installations. Reward Hospitality warrants its sinks to be free from all manufacturing defects in material and workmanship. Reward Hospitality warrants the waste kits, basket sieves and overflow assembly to be free from manufacturing defects for a period of one (1) year. Reward Hospitality warrants taps to be free from manufacturing defects for a period of five (5) years, the supply hose and inner cartridge for a period of five (5) years, and the inner parts including the aerator and O-ring for a period of one (1) year from the date of purchase. Reward Hospitality will repair or replace (at Reward Hospitality's discretion), at no charge, excluding labour, any product supplied by Reward Hospitality that is proven to be defective under normal use.