

## DELTA UNDERCOUNTER REFRIGERATION



# USER MANUAL

## DELTA UNDERCOUNTER REFRIGERATION

### MODELS:

ERD128 • ERD129 • ERD132 • ERD133 • ERD134 • ERD135 • ERD136  
ERD137 • ERD138 • ERD150 • ERD151

DISTRIBUTED BY:



p: 0800 503 335 | w: [www.southernhospitality.co.nz](http://www.southernhospitality.co.nz)  
e: [online@southernhospitality.co.nz](mailto:online@southernhospitality.co.nz)

## TABLE OF CONTENTS

Important safety instructions.....	3
Unpacking and installation.....	3
Electrical connection.....	4
Start-up of the cabinet.....	4
Thermostat.....	5
Defrosting.....	6
Maintenance and cleaning.....	6
Service.....	6
Disposal.....	6

### Important safety instructions

1. To obtain full use of the cabinet, we recommend reading this instruction manual.
2. It is the user's responsibility to operate the appliance in accordance with the instructions given.
3. Contact your dealer immediately in case of any malfunctions.
4. Place the cabinet in a dry and ventilated place.
5. Keep the cabinet away from strongly heat-emitting sources and do not expose it to direct sunlight.
6. Always keep in mind that all electrical devices are sources of potential danger.
7. Do not store flammable material such as thinner, gasoline, etc., in the cabinet.
8. We declare that no asbestos nor any CFC are used in the construction.
9. The oil in the compressor does not contain PCB.

### Unpacking and installation

Remove the wooden pallet and the packing. External surfaces are supplied with a protection foil, which must be removed before installation. To ensure correct function it is important that the cabinet is level.

The cabinet is supplied with legs, these can be adjusted. See Fig. 11.

Fig 1.1

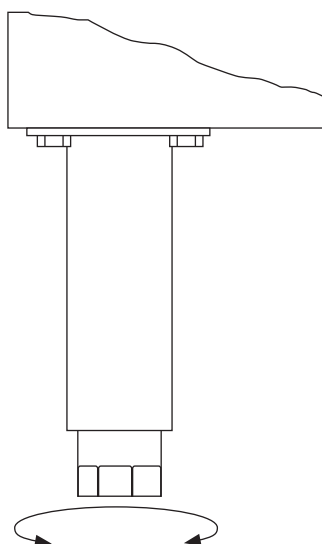

### Electrical connection

The cabinet operates on 230V/50Hz. The wall socket should be easily accessible.

All earthing requirements stipulated by the local electricity authorities must be observed. The cabinet plug and wall socket should then give correct earthing. If in doubt, contact your local supplier or authorised electrician.

The flexible cord fitted to this appliance has three cores for use with a 3 pin, 13 amp or 3 pin 15 amp plug. If a B.S. 1363 (13 amp) fused plug is used, it should be fitted with a 13 amp fuse.

The wires in this mains lead are coloured in accordance with the following code: Green/ Yellow: Earth, Blue: Neutral, Brown: Live.

The main electrical connections must be done by skilled electricians.

### Start-up of the cabinet

Before use, we recommend that the cabinet is cleaned (*see the section on maintenance and cleaning*).

#### Important!

If the cabinet has been vertically placed during transport, please wait 2 hours before turning the cabinet on.

Connect the cabinet to a socket and turn on the switch on the control panel, see Fig 1.9

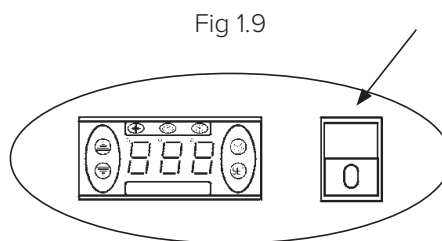

### Thermostat

The thermostat is placed in the control panel, see fig. 2.0.

The thermostat has been pre-set and in most cases it is not necessary to adjust the settings.

When turning on the cabinet the display will show the current temperature in the cabinet.

Fig 2.0

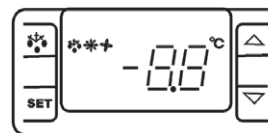



### Display set temperature

 Press this key and the display will show the set temperature. Press the key again to return to normal reading.

### Set new temperature:

 Press this key and the display shows the set temperature.

 Press this key to increase the set temperature.

 Press this key to lower the set temperature.

 Press this key to save the new settings. The display will flash with the new value and will then return to normal reading.

### Alarm codes

**PF1**—Flashing in the display: indicates that the cabinet sensor is defective. The cabinet will strive to keep the set temperature until it has been repaired.

**PF2**—Flashing in the display: indicates that the evaporator sensor is defective. This does not influence the operation of the cabinet, but should be repaired as soon as possible.

## Defrosting

The cabinet defrosts automatically with pre-set intervals. If the door to the cabinet is opened or the contents of the cabinet is changed frequently it may become necessary to defrost the cabinet manually.



Pressing this key continuously for more than 3 seconds will start a manual defrosting and then return to normal operation.

Defrosted water runs to a container placed in the compressor compartment and evaporates.

## Maintenance and cleaning

Switch the cooler off at the socket.

The cabinet must be periodically cleaned. Clean the external and internal surfaces of the cabinet with a light soap solution and subsequently wipe dry. External surfaces can be maintained using steel oil.

Do NOT use cleansers containing chlorine or other harsh cleansers, as these can damage the stainless steel surfaces and the internal cooling system.

Clean the condenser and the compressor compartment using a vacuum cleaner and a stiff brush.

Do NOT hose the compressor compartment with water as this can cause short circuits and damage on the electrical parts.

## Service

The cooling system is a hermetically sealed system and does not require supervision, only cleaning. If the cabinet fails to cool, check if the reason is a power cut.

If you cannot locate the reason to the failure of the cabinet, please contact your supplier. Please inform model and serial number of the cabinet. You can find this information on the rating label which is placed inside the cabinet in the top right hand side.

## Disposal

Disposal of the cabinet must take place in an environmentally correct way. Please note existing regulation on disposal. There may be special requirements and conditions which must be observed.

