

Cook & Hold Oven

Simple Control

300-TH	750-SK
500-TH	1000-SK
750-TH	1200-SK
1000-TH	1750-SK
1200-TH	
1750-TH	



MN-46709-EN

REV.03
1/22

EN

For the most current manual, visit alto-shaam.com
Die neueste Fassung des Handbuchs finden Sie auf alto-shaam.com
Pour la dernière version du manuel, visitez alto-shaam.com
Para obtener el manual más actual, visite alto-shaam.com
Ga voor de meest recente handleiding naar alto-shaam.com
За самой последней версии руководства обращайтесь на сайт alto-shaam.com
要查看当前最新手册，请访问 alto-shaam.com



Manufacturer's Information

Copyright

© Copyright 1/22 by Alto-Shaam, Inc.

All rights reserved.

This manual or any portion thereof may not be reproduced or used in any manner whatsoever without the express written permission of Alto-Shaam, Inc.

Trademarks

All trademarks referenced in this documentation are the property of their respective owners.

Manufacturer

Alto-Shaam, Inc.

P.O. Box 450

W164 N9221 Water Street

Menomonee Falls, WI 53052

Original instructions

The content in this manual is written in American English.

Enjoy your Alto-Shaam® Cook & Hold Oven!

Halo Heat® Technology

Cook & Hold Oven

Precise, low-temperature cooking with Halo Heat technology perfected prime rib for decades. Free up time with overnight cooking for corned beef, confit, and even yogurt. Cook your food to perfection and hold for hours without compromising food quality. No fans. No hood needed. Only big flavor and savings.

Smoker Oven

The Alto-Shaam smoker oven can make a big impact on your operation. Use hot or cold smoke to prepare anything from brisket to cheese. Cook your food to perfection, and/or smoke it to perfection, then hold it for hours without compromising food quality.

Extend Your Manufacturer's Warranty

Register

Register your Alto-Shaam appliance online. Registering your appliance ensures prompt service in the event of a warranty claim.

Your personal information will not be shared with any other company.

alto-shaam.com/warranty

Alto-Shaam 24/7 Emergency Repair Service

Call

Call 800-558-8744 to reach our 24-hour emergency service call center for immediate access to local authorized service agencies outside standard business hours. The emergency service access is provided exclusively for Alto-Shaam equipment and is available throughout the United States through Alto-Shaam's toll free number.

Availability

Emergency service access is available seven days a week, including holidays.

This page is intentionally left blank.

Manufacturer's Information	2
Foreword	3
Enjoy your Alto-Shaam® Cook & Hold Oven!	3
Extend Your Manufacturer's Warranty	3
Alto-Shaam 24/7 Emergency Repair Service	3
Table of Contents	5
Safety	7
The Meaning of Signal Words	7
Safety Precautions.	8
Labels	11
Label Locations	11
Installation	15
Dimension Drawings	15
Pre-Installation Checklist	21
Installation Checklist	24
How to Receive the Appliance	26
How to Unpack the Oven	27
How to Install the Oven.	28
How to Connect the Electrical Wiring	34
How to Install the Drip Tray	37
How to Stack Two Ovens	38
Operation	39
Control Identification	39
How to Prepare the Oven for First Use	40
How to Use the Door Vents	41
How to Turn On and Turn Off the Oven	42
How to Cook by Time (Optional Smoking)	43
How to Cook by Probe	47
How to Hold at a Set Temperature	51
How to Prepare the Smoker Box for Smoking	52
How to Cold Smoke	53
How to Load Recipes from a USB Drive.	55
How to Save Recipes to a USB Drive	57
How to Create and Store a Recipe.	59
How to Cook Using a Recipe	61
How to Turn on or Turn off the Alert Function.	63
How to Lock and Unlock the Controller.	64
How to Change the Temperature Scale.	65

TABLE OF CONTENTS

How to Calibrate the Temperature Probe	66
How to Update Software with a USB Drive	68
How to View the Software Versions.	72
How to Set the Date and Time for HACCP Data (if equipped)	74
How to Download HACCP Data (if equipped)	76
Maintenance	79
Maintenance Schedule	79
How to Clean the Oven.	81
Troubleshooting	83
Error Codes	83
What to do if a Power Interruption Occurs	85
Warranty	87
Warranty.	87
Declaration of Conformity	89

The Meaning of Signal Words

This manual contains signal words where needed. These signal words must be obeyed to reduce the risk of death, personal injury, or equipment damage. The meaning of these signal words is explained below.

**DANGER**

Danger indicates a hazardous situation which, if not avoided, will result in serious injury or death.

**WARNING**

Warning indicates a hazardous situation which, if not avoided, could result in serious injury or death.

**CAUTION**

Caution indicates a hazardous situation which, if not avoided, could result in minor or moderate injury.

NOTICE

Notice indicates a situation which, if not avoided, could result in property damage.



NOTE: Note indicates additional information that is important to a concept or procedure.

Safety Precautions

Before you begin

Read and understand all instructions in this manual.

Electrical precautions

Obey these electrical precautions when using the appliance:

- Connect the appliance to a properly grounded outlet. Do not use the appliance if it is not properly grounded. Consult an electrician if there is any doubt that the outlet used is properly grounded.
 - Keep the cord away from hot surfaces.
 - Do not attempt to service the appliance or its cord and plug.
 - Do not operate the appliance if it has a damaged cord or plug.
 - Do not immerse the cord or plug in water.
 - Do not let the cord hang over the edge of a table or counter.
 - Do not use an extension cord.
-

Usage precautions

Obey these usage precautions when using the appliance:

- Only use this appliance for its intended use of heating or cooking.
 - Always keep liquids, or foods that can become liquid when heated, level and at or below eye level where they can be seen.
 - Always open the appliance door very slowly. Escaping hot vapors or steam can cause serious injury.
 - Use utensils and protective clothing such as dry oven mitts when loading and unloading the appliance.
 - Use caution when using the appliance. Floors adjacent to the appliance may become slippery.
 - Do not cover or block any of the openings of this appliance.
 - Do not cover shelves or any other part of this appliance with metal foil.
 - Do not use this appliance near water such as a sink, in a wet location, near a swimming pool, or similar locations.
-

Maintenance precautions

Obey these maintenance precautions when maintaining the appliance:

- Obey precautions in the manual, on tags, and on labels attached to or shipped with the appliance.
- Only clean the appliance when the oven is disconnected from the power source.
- Do not store the appliance outdoors.
- Do not clean the appliance with metal scouring pads.
- Do not use corrosive chemicals when cleaning the appliance.
- Do not use a hose or water jet to clean the appliance.
- Do not use the appliance cavity for storage.
- Do not leave flammable materials, cooking utensils, or food inside the appliance when it is not in use.

Continued on next page

Continued from previous page

Operator training

All personnel using the appliance must have proper operator training. Before using the appliance:

- Read and understand the operating instructions contained in all the documentation delivered with the appliance.
- Know the location and proper use of all controls.
- Keep this manual and all supplied instructions, diagrams, schematics, parts lists, notices, and labels with the appliance if the appliance is sold or moved to another location.
- Contact Alto-Shaam for additional training if needed.

Operator qualifications

Only trained personnel with the following operator qualifications are permitted to use the appliance:

- Have received proper instruction on how to use the appliance.
- Have demonstrated their ability with commercial kitchens and commercial appliances.

The appliance must not be used by:

- Persons (including children) with reduced physical, sensory or mental capabilities, or lack of experience and knowledge, unless they have been given supervision concerning use of the appliance by person responsible for their safety.
- People impaired by drugs or alcohol.

- Children should be supervised to ensure that they do not play with the appliance.
- Children shall neither clean nor maintain the appliance.

Condition of appliance

Only use the appliance when:

- All controls operate correctly.
- The appliance is installed correctly.
- The appliance is clean.
- The appliance labels are legible.

Servicing the appliance

- Only trained personnel are permitted to service or repair the appliance. Repairs that are not performed by an authorized service partner or trained technician will void the warranty and relieve Alto-Shaam of all liability.
- To prevent serious injury, death or property damage, have the appliance inspected and serviced at least every twelve (12) months by an authorized service partner or trained technician.
- Contact Alto-Shaam for the authorized service partner in your area.

Continued on next page

Continued from previous page

Personal Protective Equipment (PPE)

Wear the following Personal Protective Equipment (PPE) while cleaning the appliance:

- Protective gloves
- Protective clothing
- Eye protection
- Face protection

Use of restraining devices

A restraining device (tether) must be installed to any appliance that is hard-wired and mounted on casters. The tether must:

- Be secured to the building's structure.
- Limit the movement of the appliance so that no stress is transmitted to the electrical conduit.

A connection point for the tether is located on the back of the appliance.



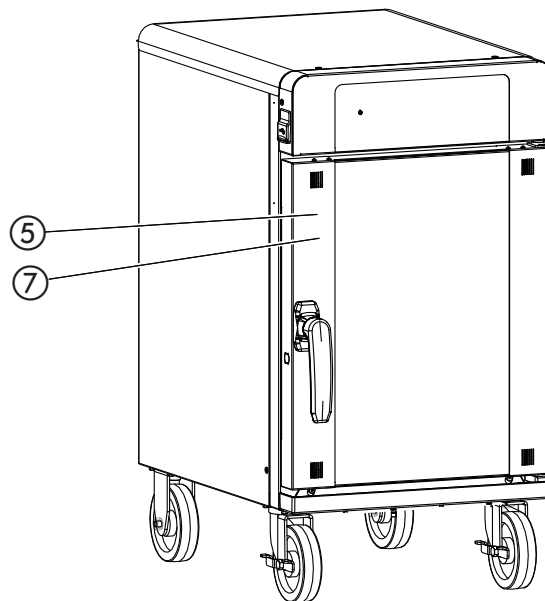
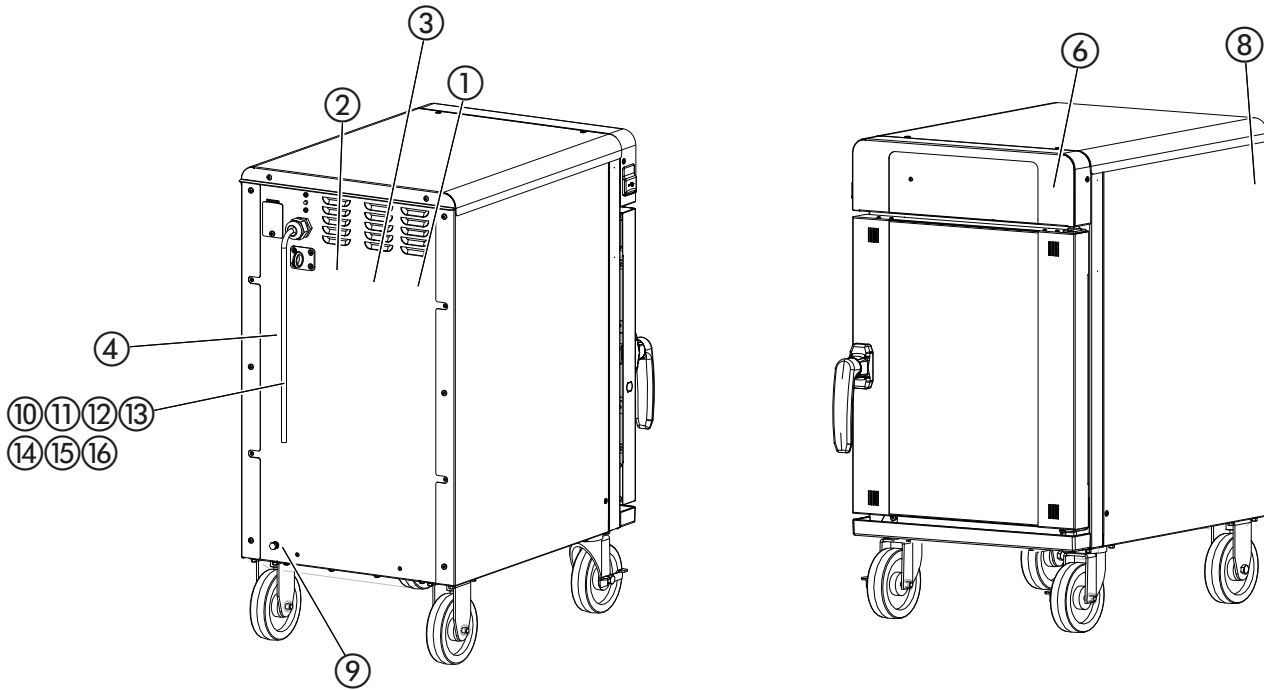

A tether is not supplied by nor available from the manufacturer.





Label Locations

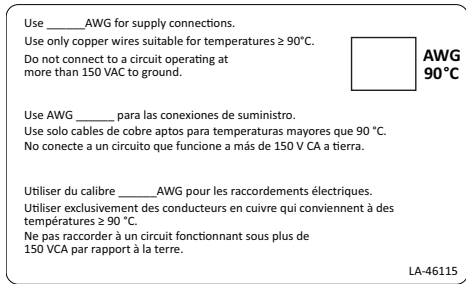
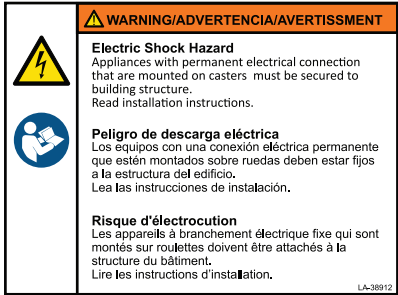
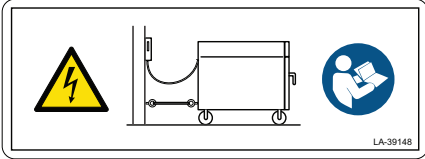































TH-PHD-008787

LABELS

<p>1</p>	 	<p>WARNING</p> <p>Electric shock hazard</p> <p>To reduce the risk of electric shock, do not remove or open the cover. No user-serviceable parts inside. Refer servicing to qualified personnel. Qualified personnel: Disconnect power before servicing.</p>
<p>2</p>		<p>Note: This label is only used on UL-certified appliances that have 120V to ground wiring.</p> <p>Use _____ AWG for supply connections.</p> <p>Use only copper wires suitable for temperature less than or equal to 90°C.</p> <p>Do not connect to a circuit operating at more than 150 VAC to ground.</p> <p>For use on individual branch circuits only.</p>
<p>3</p>	 	<p>WARNING</p> <p>Electric shock hazard</p> <p>Appliances with permanent electrical connection that are mounted on casters must be secured to building structure. Read installation instructions.</p>
<p>4</p>		<p>Every Alto-Shaam product is precision calibrated prior to release from the factory to ensure accurate temperature control.</p>

5		<p>WARNING Hot surface</p>
6		<p>Made in U.S.A.</p>
7		<p>WARNING Burn hazard Always load liquids, or foods that can become liquid when heated, at an eye level where they can be seen.</p>
8		<p>Security seal</p>
9	 <p>LA-36443-E</p>	<p>Equipotential bonding</p>
10	<p>For use on individual branch circuit only.</p> <p>Utiliser exclusivement sur un propre circuit de dérivation séparé.</p> <p>Nur zum Anschluss an einen Einzelstromkreis geeignet.</p> <p>Para su uso en circuitos derivados individuales solamente.</p> <p>禁止和其他任何电器设备共用供电回路。必须独立分配一路给该设备</p> <p>LA-3088</p>	<p>For use on individual branch circuit only.</p>
11	<p>"WARNING" RISK OF FIRE! "ATTENTION" RISQUE D'INCENDIE !</p> <p>Use a UL Listed grounding type plug rated 240 Volts, 30 Amperes, 1 Phase, 3 wire for single phase units. Plug to be selected and installed only by qualified service personnel.</p> <p>Utilisez une prise homologuée UL conforme pour 240 Volts, 30 Amp res, monophasé, 3 fils pour les appareils monophasés. Les prises ne doivent être sélectionnées et installées que par du personnel de service qualifié.</p> <p>ADVERTENCIA: RIESGO DE INCENDIOS "WARNUNG" BRANDGEFAHR!</p> <p>Utilice un enchufe con toma de tierra de los que se incluyen en las listas de la UL de 240 voltios, 30 amperios, monofásico de 3 hilos para unidades monofásicas. La elección e instalación del enchufe lo realizará exclusivamente personal cualificado del servicio.</p> <p>Verwenden Sie bei Geräten mit Einphasenanschluss einen Schutzkontakt-Stecker 240V/30 A mit 3-adrigem Anschluss und. Die Auswahl und Montage des Steckers darf nur durch einen Fachmann erfolgen.</p> <p>LA-26989</p>	<p>WARNING Fire hazard Use a UL Listed grounding type plug rated 240 Volts, 30 Amperes, 1 Phase, 3 wire for single phase units. Plug to be selected and installed only by qualified service personnel.</p>

<p>12</p>	<table border="1"> <tr> <td data-bbox="261 216 521 348">  <p>WARNING</p> <p>Fire Hazard Use a UL Listed grounding type plug rated 240 Volts, 20 Amperes, 1 Phase, 3 wire for single phase units. Plug to be selected and installed only by qualified service personnel.</p> </td> <td data-bbox="521 216 581 348"> <p>240V, 20A</p> </td> <td data-bbox="581 216 829 348">  <p>ADVERTENCIA/AVERTISSEMENT</p> <p>Peligro de incendio Utilice un enchufe con toma de tierra de los que se incluyen en las listas de la UL, de 240 voltios, 20 amperios, monofásico de 3 hilos para unidades monofásicas. La elección e instalación del enchufe la realizará exclusivamente personal cualificado del servicio.</p> <p>Risque d'incendie Utilisez une prise homologuée UL, conforme pour 240 Volts, 20 Amperes, monophasé, 3 fils pour les appareils monophasés. Les prises ne doivent être sélectionnées et installées que par du personnel de service qualifié. L4-4546</p> </td> </tr> </table>	 <p>WARNING</p> <p>Fire Hazard Use a UL Listed grounding type plug rated 240 Volts, 20 Amperes, 1 Phase, 3 wire for single phase units. Plug to be selected and installed only by qualified service personnel.</p>	<p>240V, 20A</p>	 <p>ADVERTENCIA/AVERTISSEMENT</p> <p>Peligro de incendio Utilice un enchufe con toma de tierra de los que se incluyen en las listas de la UL, de 240 voltios, 20 amperios, monofásico de 3 hilos para unidades monofásicas. La elección e instalación del enchufe la realizará exclusivamente personal cualificado del servicio.</p> <p>Risque d'incendie Utilisez une prise homologuée UL, conforme pour 240 Volts, 20 Amperes, monophasé, 3 fils pour les appareils monophasés. Les prises ne doivent être sélectionnées et installées que par du personnel de service qualifié. L4-4546</p>	<p>WARNING</p> <p>Fire hazard</p> <p>Use a UL Listed grounding type plug rated 240 Volts, 20 Amperes, 1 Phase, 3 wire for single phase units. Plug to be selected and installed only by qualified service personnel.</p>
 <p>WARNING</p> <p>Fire Hazard Use a UL Listed grounding type plug rated 240 Volts, 20 Amperes, 1 Phase, 3 wire for single phase units. Plug to be selected and installed only by qualified service personnel.</p>	<p>240V, 20A</p>	 <p>ADVERTENCIA/AVERTISSEMENT</p> <p>Peligro de incendio Utilice un enchufe con toma de tierra de los que se incluyen en las listas de la UL, de 240 voltios, 20 amperios, monofásico de 3 hilos para unidades monofásicas. La elección e instalación del enchufe la realizará exclusivamente personal cualificado del servicio.</p> <p>Risque d'incendie Utilisez une prise homologuée UL, conforme pour 240 Volts, 20 Amperes, monophasé, 3 fils pour les appareils monophasés. Les prises ne doivent être sélectionnées et installées que par du personnel de service qualifié. L4-4546</p>			
<p>13</p>	<table border="1"> <tr> <td data-bbox="261 457 521 590">  <p>WARNING</p> <p>Fire Hazard Use a UL Listed grounding type plug rated 120 Volts, 30 Amperes, 1 Phase, 3 wire for single phase units. Plug to be selected and installed only by qualified service personnel.</p> </td> <td data-bbox="521 457 581 590"> <p>120V, 30A</p> </td> <td data-bbox="581 457 829 590">  <p>ADVERTENCIA/AVERTISSEMENT</p> <p>Peligro de incendio Utilice un enchufe con toma de tierra de los que se incluyen en las listas de la UL, de 120 voltios, 30 amperios, monofásico de 3 hilos para unidades monofásicas. La elección e instalación del enchufe la realizará exclusivamente personal cualificado del servicio.</p> <p>Risque d'incendie Utilisez une prise homologuée UL, conforme pour 120 Volts, 30 Amperes, monophasé, 3 fils pour les appareils monophasés. Les prises ne doivent être sélectionnées et installées que par du personnel de service qualifié. L4-4547</p> </td> </tr> </table>	 <p>WARNING</p> <p>Fire Hazard Use a UL Listed grounding type plug rated 120 Volts, 30 Amperes, 1 Phase, 3 wire for single phase units. Plug to be selected and installed only by qualified service personnel.</p>	<p>120V, 30A</p>	 <p>ADVERTENCIA/AVERTISSEMENT</p> <p>Peligro de incendio Utilice un enchufe con toma de tierra de los que se incluyen en las listas de la UL, de 120 voltios, 30 amperios, monofásico de 3 hilos para unidades monofásicas. La elección e instalación del enchufe la realizará exclusivamente personal cualificado del servicio.</p> <p>Risque d'incendie Utilisez une prise homologuée UL, conforme pour 120 Volts, 30 Amperes, monophasé, 3 fils pour les appareils monophasés. Les prises ne doivent être sélectionnées et installées que par du personnel de service qualifié. L4-4547</p>	<p>WARNING</p> <p>Fire hazard</p> <p>Use a UL Listed grounding type plug rated 120 Volts, 30 Amperes, 1 Phase, 3 wire for single phase units. Plug to be selected and installed only by qualified service personnel.</p>
 <p>WARNING</p> <p>Fire Hazard Use a UL Listed grounding type plug rated 120 Volts, 30 Amperes, 1 Phase, 3 wire for single phase units. Plug to be selected and installed only by qualified service personnel.</p>	<p>120V, 30A</p>	 <p>ADVERTENCIA/AVERTISSEMENT</p> <p>Peligro de incendio Utilice un enchufe con toma de tierra de los que se incluyen en las listas de la UL, de 120 voltios, 30 amperios, monofásico de 3 hilos para unidades monofásicas. La elección e instalación del enchufe la realizará exclusivamente personal cualificado del servicio.</p> <p>Risque d'incendie Utilisez une prise homologuée UL, conforme pour 120 Volts, 30 Amperes, monophasé, 3 fils pour les appareils monophasés. Les prises ne doivent être sélectionnées et installées que par du personnel de service qualifié. L4-4547</p>			
<p>14</p>	<table border="1"> <tr> <td data-bbox="261 716 521 848">  <p>WARNING</p> <p>Fire Hazard Use a UL Listed grounding type plug rated 208–240 Volts, 15 Amperes, 1 Phase, 3 wire for single phase units. Plug to be selected and installed only by qualified service personnel.</p> </td> <td data-bbox="521 716 581 848"> <p>208–240V, 15A</p> </td> <td data-bbox="581 716 829 848">  <p>ADVERTENCIA/AVERTISSEMENT</p> <p>Peligro de incendio Utilice un enchufe con toma de tierra de los que se incluyen en las listas de la UL, de 208–240 voltios, 15 amperios, monofásico de 3 hilos para unidades monofásicas. La elección e instalación del enchufe la realizará exclusivamente personal cualificado del servicio.</p> <p>Risque d'incendie Utilisez une prise homologuée UL, conforme pour 208–240 Volts, 15 Amperes, monophasé, 3 fils pour les appareils monophasés. Les prises ne doivent être sélectionnées et installées que par du personnel de service qualifié. L4-4548</p> </td> </tr> </table>	 <p>WARNING</p> <p>Fire Hazard Use a UL Listed grounding type plug rated 208–240 Volts, 15 Amperes, 1 Phase, 3 wire for single phase units. Plug to be selected and installed only by qualified service personnel.</p>	<p>208–240V, 15A</p>	 <p>ADVERTENCIA/AVERTISSEMENT</p> <p>Peligro de incendio Utilice un enchufe con toma de tierra de los que se incluyen en las listas de la UL, de 208–240 voltios, 15 amperios, monofásico de 3 hilos para unidades monofásicas. La elección e instalación del enchufe la realizará exclusivamente personal cualificado del servicio.</p> <p>Risque d'incendie Utilisez une prise homologuée UL, conforme pour 208–240 Volts, 15 Amperes, monophasé, 3 fils pour les appareils monophasés. Les prises ne doivent être sélectionnées et installées que par du personnel de service qualifié. L4-4548</p>	<p>WARNING</p> <p>Fire hazard</p> <p>Use a UL Listed grounding type plug rated 208–240 Volts, 15 Amperes, 1 Phase, 3 wire for single phase units. Plug to be selected and installed only by qualified service personnel.</p>
 <p>WARNING</p> <p>Fire Hazard Use a UL Listed grounding type plug rated 208–240 Volts, 15 Amperes, 1 Phase, 3 wire for single phase units. Plug to be selected and installed only by qualified service personnel.</p>	<p>208–240V, 15A</p>	 <p>ADVERTENCIA/AVERTISSEMENT</p> <p>Peligro de incendio Utilice un enchufe con toma de tierra de los que se incluyen en las listas de la UL, de 208–240 voltios, 15 amperios, monofásico de 3 hilos para unidades monofásicas. La elección e instalación del enchufe la realizará exclusivamente personal cualificado del servicio.</p> <p>Risque d'incendie Utilisez une prise homologuée UL, conforme pour 208–240 Volts, 15 Amperes, monophasé, 3 fils pour les appareils monophasés. Les prises ne doivent être sélectionnées et installées que par du personnel de service qualifié. L4-4548</p>			
<p>15</p>	<table border="1"> <tr> <td data-bbox="261 957 521 1089">  <p>WARNING</p> <p>Fire Hazard Use a UL Listed grounding type plug rated 120 Volts, 20 Amperes, 1 Phase, 3 wire for single phase units. Plug to be selected and installed only by qualified service personnel.</p> </td> <td data-bbox="521 957 581 1089"> <p>120V, 20A</p> </td> <td data-bbox="581 957 829 1089">  <p>ADVERTENCIA/AVERTISSEMENT</p> <p>Peligro de incendio Utilice un enchufe con toma de tierra de los que se incluyen en las listas de la UL, de 120 voltios, 20 amperios, monofásico de 3 hilos para unidades monofásicas. La elección e instalación del enchufe la realizará exclusivamente personal cualificado del servicio.</p> <p>Risque d'incendie Utilisez une prise homologuée UL, conforme pour 120 Volts, 20 Amperes, monophasé, 3 fils pour les appareils monophasés. Les prises ne doivent être sélectionnées et installées que par du personnel de service qualifié. L4-4547</p> </td> </tr> </table>	 <p>WARNING</p> <p>Fire Hazard Use a UL Listed grounding type plug rated 120 Volts, 20 Amperes, 1 Phase, 3 wire for single phase units. Plug to be selected and installed only by qualified service personnel.</p>	<p>120V, 20A</p>	 <p>ADVERTENCIA/AVERTISSEMENT</p> <p>Peligro de incendio Utilice un enchufe con toma de tierra de los que se incluyen en las listas de la UL, de 120 voltios, 20 amperios, monofásico de 3 hilos para unidades monofásicas. La elección e instalación del enchufe la realizará exclusivamente personal cualificado del servicio.</p> <p>Risque d'incendie Utilisez une prise homologuée UL, conforme pour 120 Volts, 20 Amperes, monophasé, 3 fils pour les appareils monophasés. Les prises ne doivent être sélectionnées et installées que par du personnel de service qualifié. L4-4547</p>	<p>WARNING</p> <p>Fire hazard</p> <p>Use a UL Listed grounding type plug rated 120 Volts, 20 Amperes, 1 Phase, 3 wire for single phase units. Plug to be selected and installed only by qualified service personnel.</p>
 <p>WARNING</p> <p>Fire Hazard Use a UL Listed grounding type plug rated 120 Volts, 20 Amperes, 1 Phase, 3 wire for single phase units. Plug to be selected and installed only by qualified service personnel.</p>	<p>120V, 20A</p>	 <p>ADVERTENCIA/AVERTISSEMENT</p> <p>Peligro de incendio Utilice un enchufe con toma de tierra de los que se incluyen en las listas de la UL, de 120 voltios, 20 amperios, monofásico de 3 hilos para unidades monofásicas. La elección e instalación del enchufe la realizará exclusivamente personal cualificado del servicio.</p> <p>Risque d'incendie Utilisez une prise homologuée UL, conforme pour 120 Volts, 20 Amperes, monophasé, 3 fils pour les appareils monophasés. Les prises ne doivent être sélectionnées et installées que par du personnel de service qualifié. L4-4547</p>			
<p>16</p>	<table border="1"> <tr> <td data-bbox="261 1199 521 1331">  <p>WARNING</p> <p>Fire Hazard Use a UL Listed grounding type plug rated 208–240 Volts, 50 Amperes, 1 Phase, 3 wire for single phase units. Plug to be selected and installed only by qualified service personnel.</p> </td> <td data-bbox="521 1199 581 1331"> <p>208–240V, 50A</p> </td> <td data-bbox="581 1199 829 1331">  <p>ADVERTENCIA/AVERTISSEMENT</p> <p>Peligro de incendio Utilice un enchufe con toma de tierra de los que se incluyen en las listas de la UL, de 208–240 voltios, 50 amperios, monofásico de 3 hilos para unidades monofásicas. La elección e instalación del enchufe la realizará exclusivamente personal cualificado del servicio.</p> <p>Risque d'incendie Utilisez une prise homologuée UL, conforme pour 208–240 Volts, 50 Amperes, monophasé, 3 fils pour les appareils monophasés. Les prises ne doivent être sélectionnées et installées que par du personnel de service qualifié. L4-4548</p> </td> </tr> </table>	 <p>WARNING</p> <p>Fire Hazard Use a UL Listed grounding type plug rated 208–240 Volts, 50 Amperes, 1 Phase, 3 wire for single phase units. Plug to be selected and installed only by qualified service personnel.</p>	<p>208–240V, 50A</p>	 <p>ADVERTENCIA/AVERTISSEMENT</p> <p>Peligro de incendio Utilice un enchufe con toma de tierra de los que se incluyen en las listas de la UL, de 208–240 voltios, 50 amperios, monofásico de 3 hilos para unidades monofásicas. La elección e instalación del enchufe la realizará exclusivamente personal cualificado del servicio.</p> <p>Risque d'incendie Utilisez une prise homologuée UL, conforme pour 208–240 Volts, 50 Amperes, monophasé, 3 fils pour les appareils monophasés. Les prises ne doivent être sélectionnées et installées que par du personnel de service qualifié. L4-4548</p>	<p>WARNING</p> <p>Fire hazard</p> <p>Use a UL Listed grounding type plug rated 208–240 Volts, 50 Amperes, 1 Phase, 3 wire for single phase units. Plug to be selected and installed only by qualified service personnel.</p>
 <p>WARNING</p> <p>Fire Hazard Use a UL Listed grounding type plug rated 208–240 Volts, 50 Amperes, 1 Phase, 3 wire for single phase units. Plug to be selected and installed only by qualified service personnel.</p>	<p>208–240V, 50A</p>	 <p>ADVERTENCIA/AVERTISSEMENT</p> <p>Peligro de incendio Utilice un enchufe con toma de tierra de los que se incluyen en las listas de la UL, de 208–240 voltios, 50 amperios, monofásico de 3 hilos para unidades monofásicas. La elección e instalación del enchufe la realizará exclusivamente personal cualificado del servicio.</p> <p>Risque d'incendie Utilisez une prise homologuée UL, conforme pour 208–240 Volts, 50 Amperes, monophasé, 3 fils pour les appareils monophasés. Les prises ne doivent être sélectionnées et installées que par du personnel de service qualifié. L4-4548</p>			

Dimension Drawings

300-TH

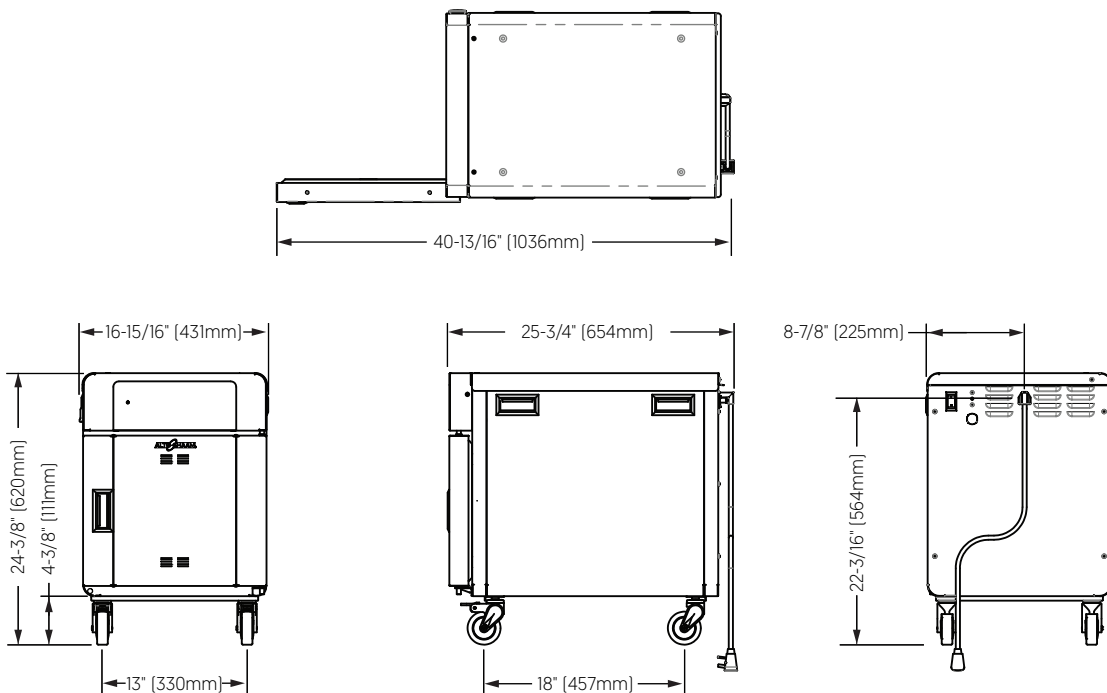
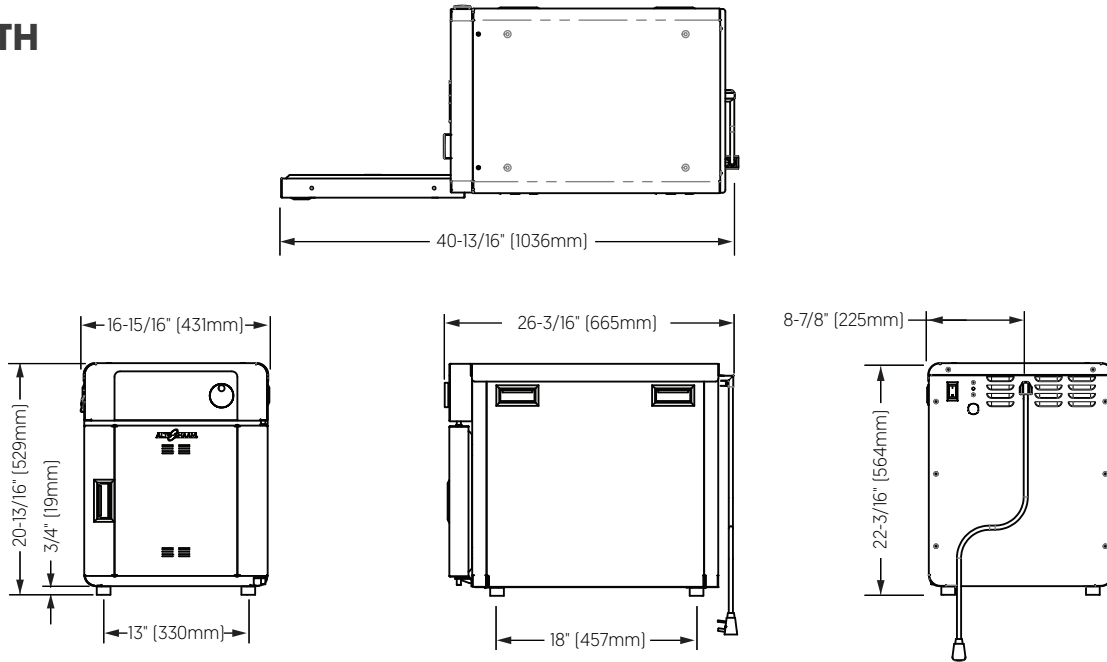

INSTALLATION

500-TH

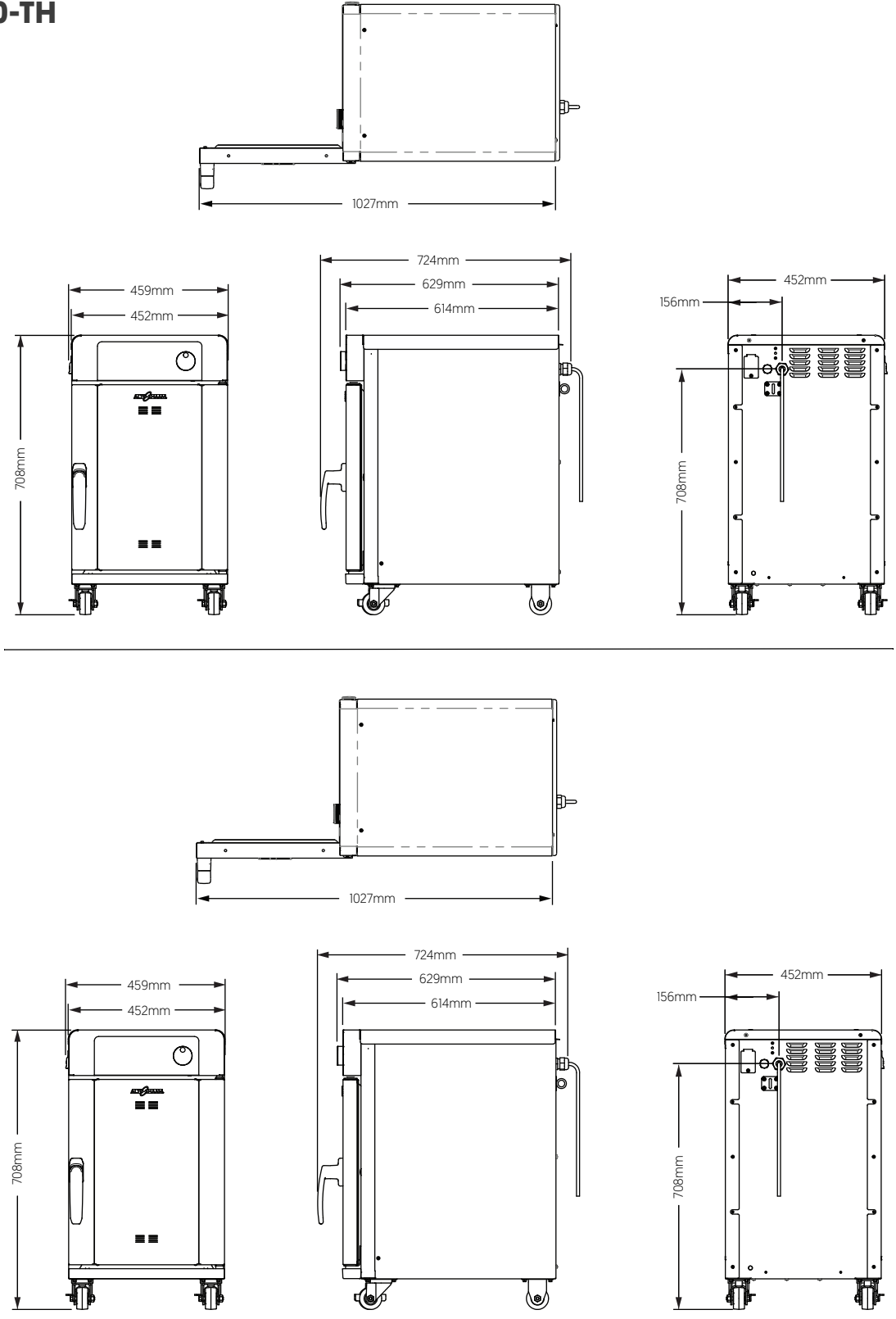

750-TH
750-SK

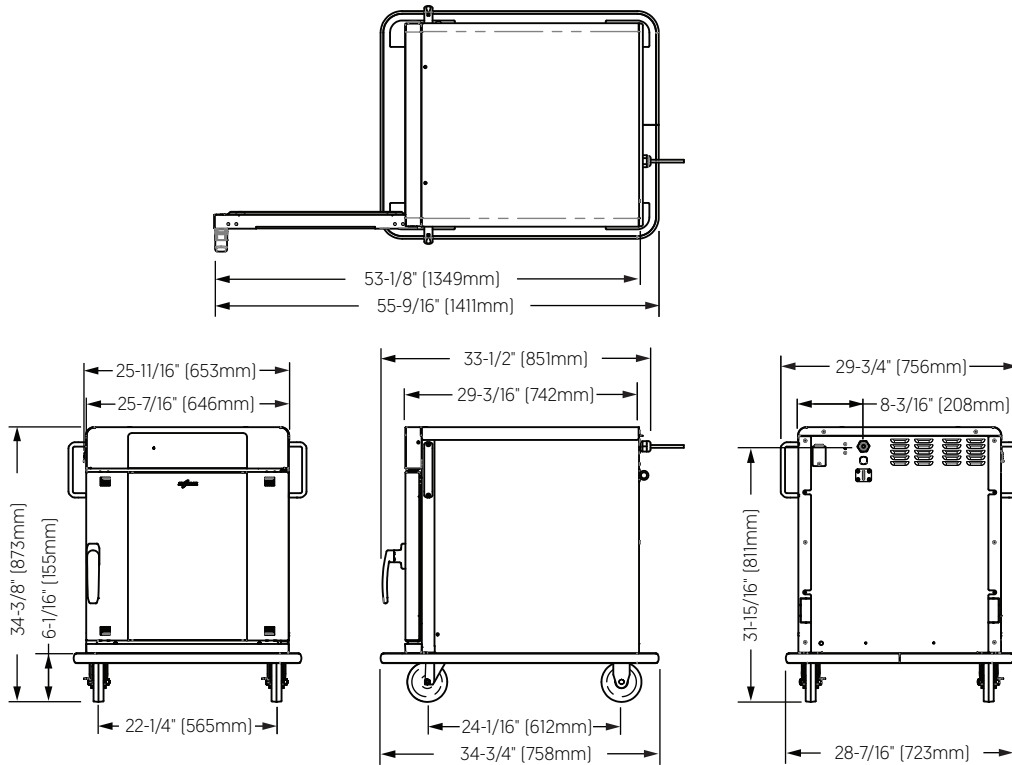
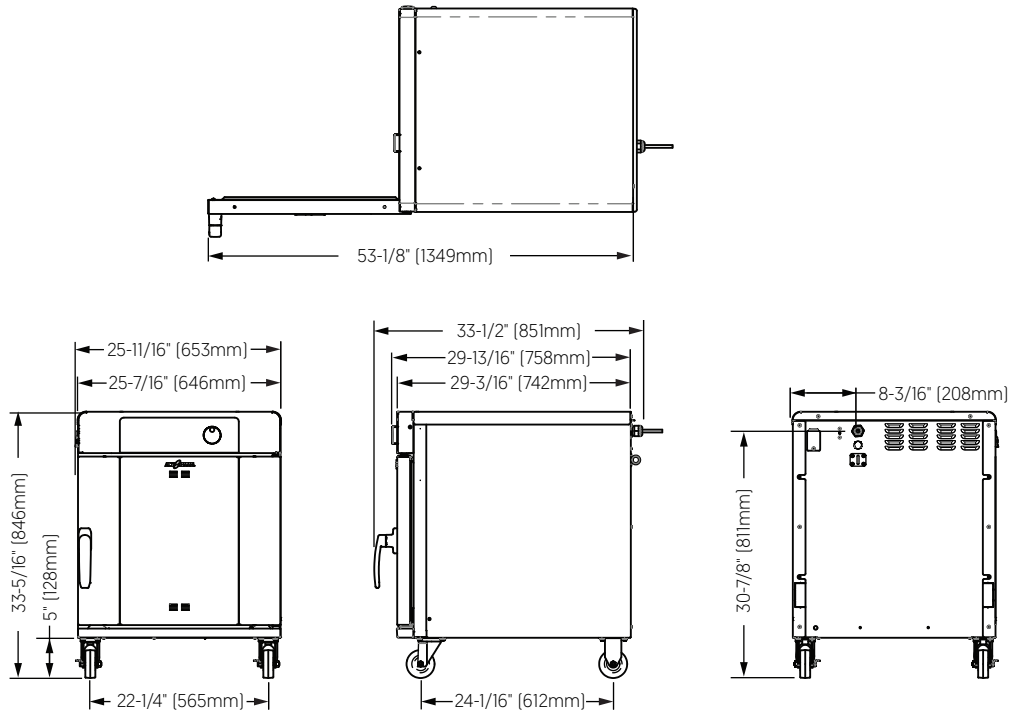

1000-TH 1000-SK

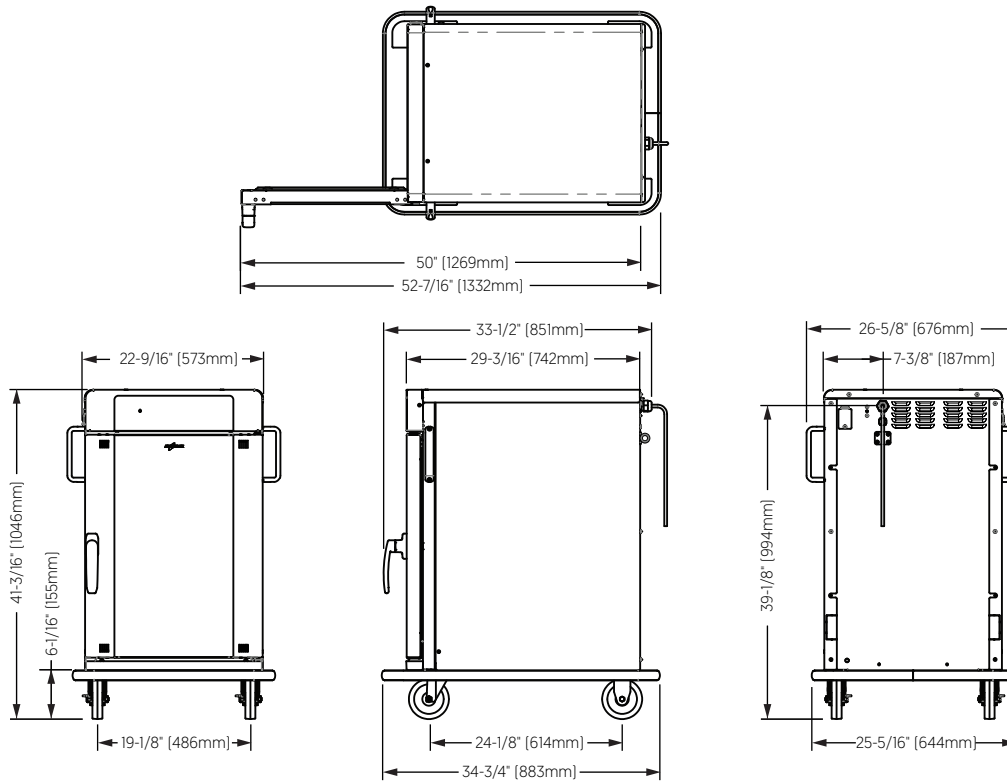
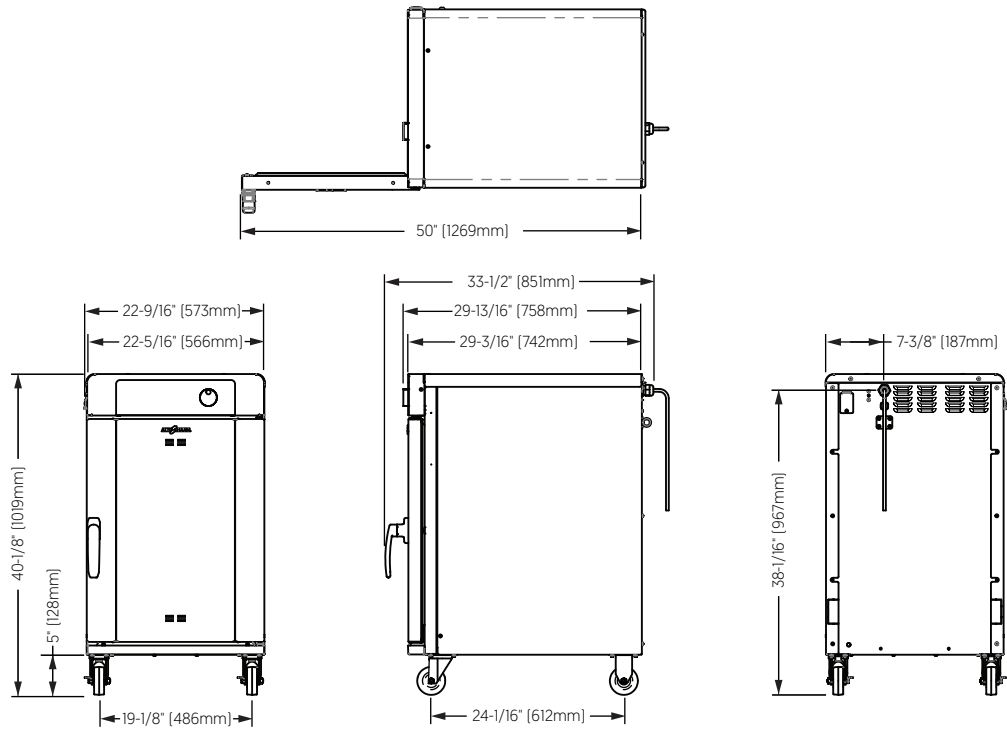

1200-TH
1200-SK

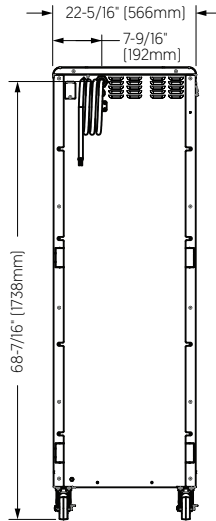
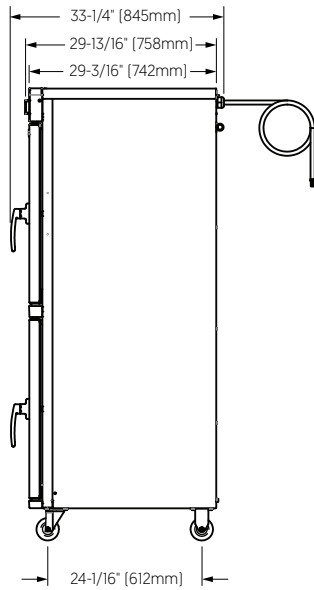
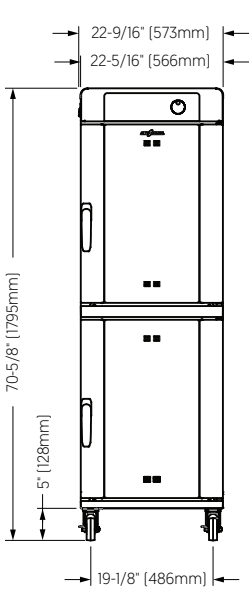
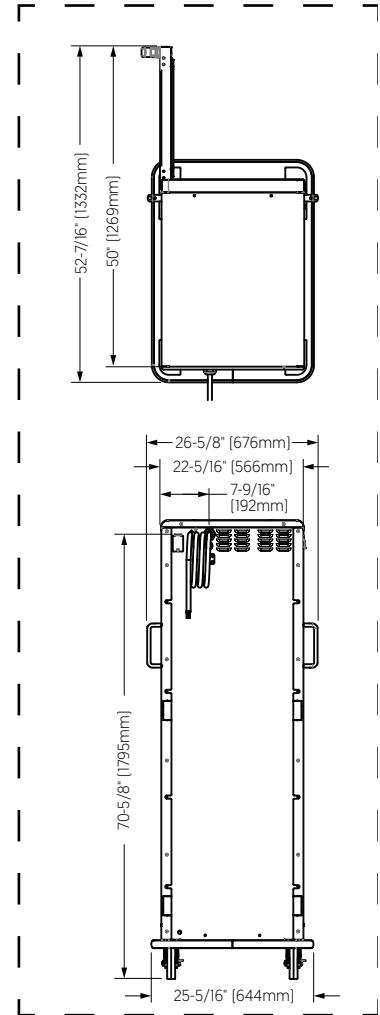
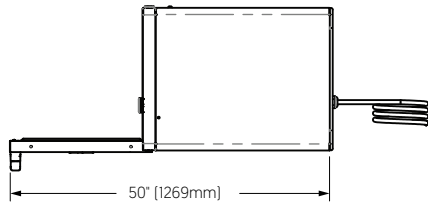

1750-TH 1750-SK

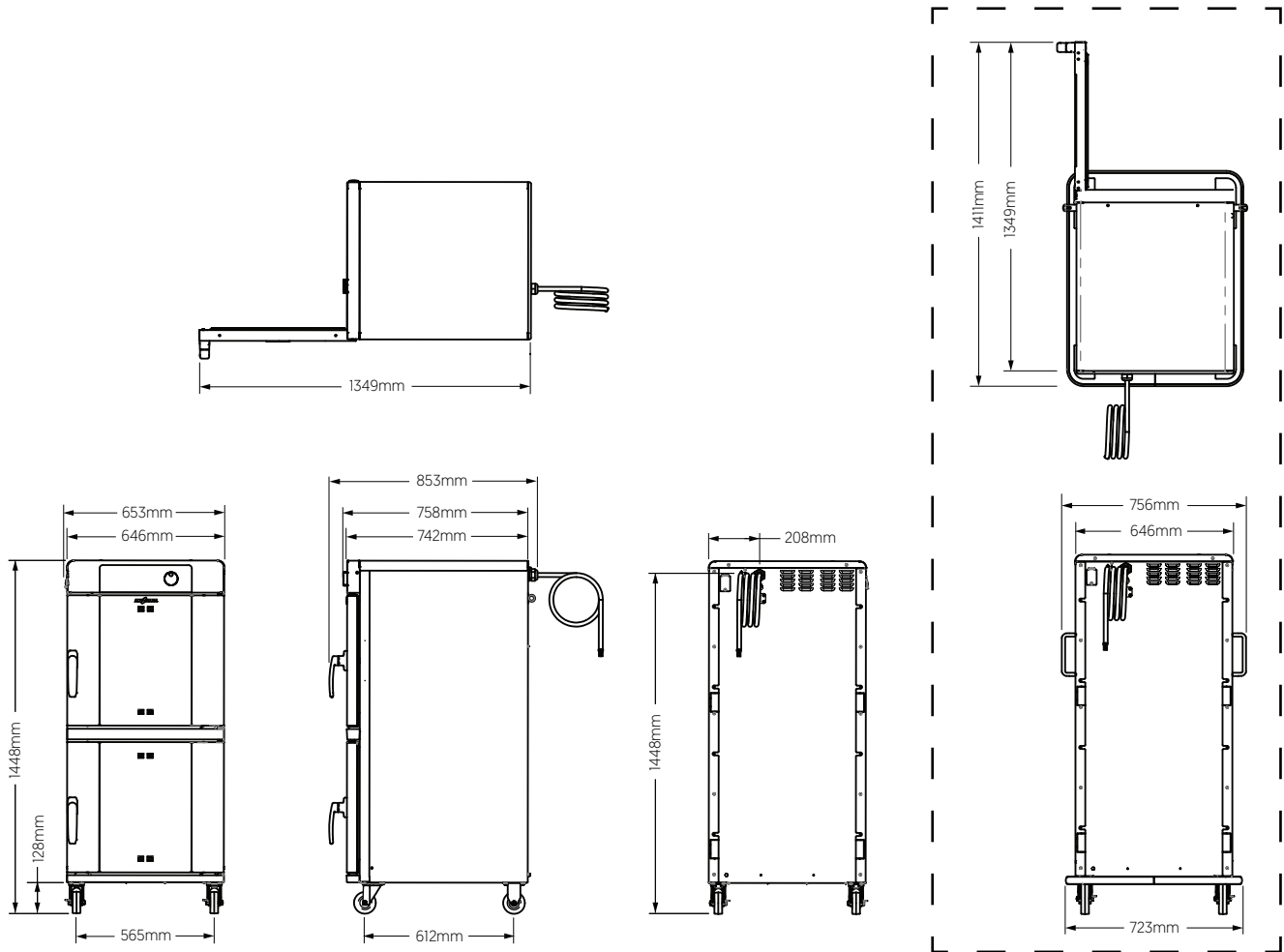

Pre-Installation Checklist

Installation of the oven is to be completed only by an authorized Alto-Shaam service partner.

Place this form with the oven's records.



WARNING: Electric shock and arc flash hazard.
Use caution when measuring line voltage and line current.
Wear Personal Protective Equipment (PPE).

Location Information

Installation date:	Start up date:
Location name:	Location address:
Contact name:	
Contact phone number:	Number of ovens to be installed:
Contact email:	Oven model number(s):
IT Administrator name: (if applicable)	Oven serial number(s):
Phone number:	Oven rated voltage:

Pre-Installation Company Information

Company name:	Mailing address:
Technician name:	
Technician phone number:	Technician email:
Date of Site Survey:	

Clearance

	Record	Pass	Fail
Measure door/entry way clearance (smallest dimension)			
Measure path clearance (smallest dimension)			
Elevator opening, if applicable (smallest dimension)			
Elevator interior dimensions, if applicable (HxWxD)			
Oven Clearance Right side:			
Rear:			
Left side:			
Top:			
Based on the oven's designated spot in the kitchen, is the oven accessible for service?	Yes / No		
If NO, comment on the issue:			
Other comments:			

Continued on next page

Continued from previous page

Electrical

Alto-Shaam oven ratings	Breaker:	Voltage:	Phase:	
	Cord:	Plug:		
Is the oven going to be hard wired?	Yes		No	
The following fields must be completed by the service technician on site.				
What is the measured voltage at the site?	L1-N:	L2-N:	L3-N:	L1-L2:
	L2-3:	L1-L3:	Pass	Fail
What is the on-site breaker size supplying power to the oven(s)?	Size:		Pass	Fail
Is there a disconnect or junction box within 3' (914mm) of where the oven(s) will be installed?	Pass	Fail		

Comments:

WiFi equipped ovens (Deluxe control only)

Is the WiFi system that will be used secure, WiFi Protected Access 2 (WPA2)? The WiFi system to be used cannot be Point of Sales WiFi.	Yes	No
Have you been provided the Service Set Identifier (SSID) for the system to be used?	Yes	No
Have you been provided the pass phrase for the WiFi system to be used?	Yes	No
At the final location that the oven will be installed, can you connect to the WiFi system with your phone?	Yes	No
At the final location that the oven will be installed, can you connect to Alto-Shaam.com with your phone using the WiFi system?	Yes	No
Is site action required?	Yes	No

Action required:

Other site information

Smoker ovens only - Is there a proper ventilation hood installed above where the oven(s) will be installed?	Pass	Fail
Does the designated location for the oven have a level surface, i.e., no more than 1.5" (38mm) change in elevation from its highest to lowest surface point?	Pass	Fail
Is the site 100% ready for oven(s) installation?	Pass	Fail
Is the ambient air temperature between 60°F (16°C) and 105°F (41°C)?	Pass	Fail
Is site action required?	Pass	Fail

Action required:

Continued on next page

Continued from previous page

Please provide a copy of this document to an on-site manager.

Service company name:

Service company number:

Model of oven(s) to be installed:

The site is ready for installation of the oven(s); planned install location passes inspection. Once the oven(s) arrive at the site (or the delivery date is certain), please contact the service company listed above to schedule the installation.

The site is NOT ready for installation of the oven(s); planned install location needs the following changes made before installation can proceed:

On-site manager should make the necessary contacts to move forward with these changes as soon as possible. If there are any questions, please contact Alto-Shaam Technical Service Department at 800-558-8744 ext. 6702.
Or, review documentation regarding the equipment www.alto-shaam.com/en/resource-library.

Once the necessary site changes have been made and the oven(s) have arrived (or the delivery date is certain), please contact the service company listed above to schedule the installation.

Technician name and signature:

On-site manager name and signature:

Installation Checklist

Installation of the oven is to be completed only by an authorized Alto-Shaam service partner.

Place this form with the oven's records.



WARNING: Electric shock and arc flash hazard.
Use caution when measuring line voltage and line current.
Wear Personal Protective Equipment (PPE).

Installation date:	Start up date:
Location name:	Location address:
Contact name:	
Contact phone number:	Oven model number:
Contact email:	Oven serial number:
IT Administrator name: (if applicable)	Oven rated voltage:
Phone number:	

Oven physical condition	Damaged		Record any damage with details before or after uncrating, location of damage, etc. Take pictures.
	Yes	No	
Front of oven			
Left side			
Back of oven			
Right side			
Top and bottom/legs			

Oven visual inspection (outside)	Yes	No
Is all packing material removed from the outside of the oven?		
Is all packing material removed from the inside of the oven?		

Oven visual inspection (internal)	Loose/Damaged	
	Yes	No
Check all electrical connections at each terminal block.		
Check all circuit board connections.		
Check all components for loose connections and hardware.		
Check the overall system for any damage from shipping or installation.		

Continued on next page

Continued from previous page

Electrical:	Record		
Measure the voltage at the wall outlet.	L1 to L2:	L1 to L3:	L2 to L3:
Measure the voltage at the oven's main disconnect switch.	L1 to L2:	L1 to L3:	L2 to L3:
Measure the voltage at the oven's main terminal block.	L1 to L2:	L1 to L3:	L2 to L3:
Measure the AC voltage to the 12 VDC power supply.			
Measure the DC output from the power supply.			

Wifi equipped ovens:

Navigate to the settings screen; touch the network icon.



On the Your network status screen:	Wireless	Ethernet
What is the connection type?		
What color is the network icon?	Red Yellow	Green
What is the Internet status?		
What is the Cloud status?		
What is the SSID?		
What is the IP Address?		

How to Receive the Appliance

Responsible parties

When an Alto-Shaam® preferred carrier is used, shipping damage is a matter between Alto-Shaam and the carrier. In such cases, contact Alto-Shaam customer service.

When an Alto-Shaam non-preferred carrier is used, shipping damage is a matter between the carrier and the consignee. In such cases, the carrier is assumed to be responsible for the safe delivery of the merchandise, unless negligence can be established on part of the shipper.

Receive the appliance

When receiving the appliance, do the following.

Step	Action
1.	Inspect the equipment while it is still in the truck or immediately after it is moved to the receiving area. Do not wait until after the equipment is moved to a storage area.
2.	Inspect and count all merchandise received. Do not sign a delivery receipt or a freight bill until you have done so.
3.	Note all damage to packaging and to the equipment on the carrier's receipt.
4.	Request the driver sign the delivery receipt. If the driver refuses to sign, make a note of this refusal on the delivery receipt.
5.	Write the following on the delivery receipt if the driver refuses to allow an inspection: Driver refuses to allow inspection of containers for visible damage.
6.	Contact the carrier immediately upon finding damage, and request an inspection. Follow the carrier's policies and procedures.

Alto-Shaam policy

It is the policy of Alto-Shaam to assist customers in collecting claims that have been properly filed and actively pursued. Alto-Shaam cannot, however, file damage claims, assume the responsibilities for damage claims, or accept deductions in payment for damage claims.

How to Unpack the Oven

Before you begin

Make sure you have:

- An appropriate lifting device and enough personnel to safely move and position the weight of the oven.
 - 300-TH/SK: 100 lbs (45 kg)
 - 500-TH/SK: 185 lbs (84 kg)
 - 750-TH/SK: 225 lbs (102 kg)
 - 1000-TH/SK: 250 lbs (113 kg)
 - 1200-TH/SK: 450 lbs (204 kg)
 - 1750-TH/SK: 440 lbs (200 kg)
- Cutting tools to remove the packaging.

Unpack the oven

To unpack the oven, do the following.

Step	Action
1.	Remove the box. Save all packing materials for inspection by the carrier.
	<div style="border: 1px solid black; padding: 5px;"> <p> NOTE: Examine the appliance for damage. If the appliance has been damaged, do not use the appliance until it has been inspected by an authorized service provider. Contact your carrier or Alto-Shaam® customer service.</p> </div>
2.	Remove the shrink wrap.
3.	Cut the restraining straps.
4.	Remove the oven from the pallet.

Result

The oven is now unpacked.

How to Install the Oven

Before you begin

Make sure you have an appropriate lifting device, and enough personnel, to safely move and position the weight of the oven.

Requirements

- The oven must be installed on a level surface.
- The oven must not be installed in any area where it may be affected by steam, grease, dripping water, high temperature, or any other severely adverse conditions.

Voltages

	V	Ph	Hz	AWG	A	Breaker*	kW	Plug***
300-TH								
120V	120	1	60	14	6.7	15	0.8	NEMA 5-15P 15A-125V CEE 7/7, BS-1363, CH2-16P
230V	230	1	50/60	14	3.2	16	0.7	
500-TH								
120V	120	1	60	10	16	20	1.9	NEMA 5-20P 20A-125V
208-240V**	208	1	60	10	11	15 UL 20 CSA	2.3	No cord, no plug
	240	1	60	10	13	15 UL 20 CSA	3.0	
230V	230	1	50/60	10	12	16	2.8	CEE 7/7, BS-1363, CH-16P
750-TH								
120V	120	1	60	10	14	20	1.7	NEMA 5-20P 20A-125V
208-240V**	208	1	60	10	15	20 UL 30 CSA	3.1	No cord, no plug No cord, no plug
	240	1	60	10	17	20 UL 30 CSA	4.2	
230V	230	1	50/60	10	17	32	3.8	CEE 7/7, BS-1363, CH-16P, CH2-16P
	230	1	50/60	10		16	2.6^	
750-SK								
120V**	120	1	60	10	17	20	2.0	No cord, no plug
208-240V**	208	1	60	10	17	20 UL 30 CSA	3.5	No cord, no plug No cord, no plug
	240	1	60	10	19	20 UL 30 CSA	4.5	
230V	230	1	50/60	10	18	32	4.2	No cord, no plug
	230	1	50/60	10		16	2.9^	

*Electrical connections must meet all applicable federal, state, and local codes.

**Dedicated circuit required.

***Additional cord and plug configurations available from factory.

^ Reduced wattage configuration.

Continued on next page

Continued from previous page

	V	Ph	Hz	IEC	AWG	A	Breaker	kW	Plug
1000-TH									
120V	120	1	60	—	10	16	20 UL 30 CSA	1.9	***
208-240V**	208	1	60	—	10	15	20 UL 30 CSA	3.1	
	240	1	60	—	10	17	20 UL 30 CSA	4.1	
230V	230	1	50/60	—	10	16	32	3.8	
	230	1	50/60	—	10		16	2.9^	
1000-SK									
120V	120	1	60	—	10	18	20 UL 30 CSA	2.2	***
208-240V**	208	1	60	—	10	17	20 UL 30 CSA	3.4	
	240	1	60	—	10	19	20 UL 30 CSA	4.5	
230V	230	1	50/60	—	10	18	32	4.1	
	230	1	50/60	—	10	16	16	2.9^	
1200-TH									
208-240V**	208	1	60	—	8	29	30 UL 50 CSA 50	6.2	***
	240	1	60	—	8	34		8.2	
230V	230	1	50/60	—	8	33	63	7.5	
	230	1	50/60	—	8	22	32	5.0^	
380-415V	380	3	50/60	2.5	10	18	32	6.9	
	415	3	50/60	2.5	10	20	32	8.2	
1200-SK									
208-240V**	208	1	60	—	8	33	50	6.9	***
	240	1	60	—	8	37	50	8.9	
230V	230	1	50/60	—	8	36	50	8.3	
	230	1	50/60	—	8	25	32	5.7^	
380-415V	380	3	50/60	2.5	10	20	25	7.7	
	415	3	50/60	2.5	10	22	32	8.9	
1750-TH									
208-240V**	208	1	60	—	8	29	30 UL 50 CSA 50	6.3	***
	240	1	60	—	8	35		8.3	
230V	230	1	50/60	—	8	33	63	7.6	
	230	1	50/60	—	8	22	32	5.1^	
380-415V	380	3	50/60	2.5	10	18	32	7.0	
	415	3	50/60	2.5	10	20	32	8.2	
1750-SK									
208-240V**	208	1	60	—	8	33	50	7.0	***
	240	1	60	—	8	38	50	9.0	
230V	230	1	50/60	—	8	36	63	8.3	
	230	1	50/60	—	8	25	32	5.8^	
380-415V	380	3	50/60	2.5	10	20	32	7.6	
	415	3	50/60	2.5	10	22	32	8.9	

*Electrical connections must meet all applicable federal, state, and local codes.

**Dedicated circuit required.

***No cord or plug. Additional cord and plug configurations available from factory.

^ Reduced wattage configuration.

Continued on next page

Continued from previous page

Electrical connection



WARNING: Appliances without a cord provided by the factory must be equipped with a cord of sufficient length to permit the appliance to be moved for cleaning.

Always use the correct AWG wire size based on the electrical requirements for the appliance.



WARNING: To prevent serious injury, death, or property damage:

All electrical connections must be made by a qualified and trained service technician in accordance with applicable electrical codes.

This appliance must be adequately grounded in accordance with local electrical codes or, in the absence of local codes, with the current edition of the National Electrical Code ANSI/NFPA No 70. In Canada, all electrical connections are to be made in accordance with CSA C22 1, Canadian Electrical Code Part 1 or local codes.

CE-approved appliances include an equipotential-bonding terminal marked with the equipotential symbol. Provisions for earthing are to be made in accordance with IEC:2010 60335-1 section 27 or local codes.



CAUTION: Electrical shock hazard.

Power source must match voltage identified on appliance rating tag. The rating tag provides essential technical information required for any appliance installation, maintenance or repairs. Do not remove, damage or modify the rating tag.

Continued on next page

Continued from previous page

Regarding international standard ovens:

If the unit is not equipped with flexible cord and plug, an all-pole country approved disconnection device which has a contact separation of at least 3mm in all poles must be incorporated in the fixed wiring for disconnection. When using a cord without a plug, the green/yellow conductor shall be connected to the terminal which is marked with the ground symbol. If a plug is used, the socket outlet must be easily accessible. If the power cord needs replacement, use a similar one obtained from the distributor.

Hard-wired models:

Hard-wired models must be equipped with a country-certified, external, all-pole disconnection switch with sufficient contact separation. Hard-wired models that are mounted on casters must have a strain relief device (tether) to prevent strain on the power supply cord. If a power cord is used for the connection of the product, an oil resistant cord like H05RN or H07RN or equivalent must be used.

NOTICE Where local codes and CE regulatory requirements apply, appliances must be connected to an electrical circuit that is protected by an external GFCI outlet.

Restraint Requirements



WARNING: Electrical shock hazard
Appliance must be secured to building structure. Failure to observe this precaution may result in severe personal injury and damage to the equipment.

Requirements for restraint:

- Maximum height of casters is 6" (152mm).
- Two of the casters must be of the locking type.
- Strain relief devices (tethers) must be secured to the building structure.

A mounting connector for a restraining device (tether) is located on the back of the appliance. The restraining device (tether) is not supplied by nor is it available from the factory.

Continued on next page

Continued from previous page

Position the oven

To position the oven, do the following.

Step	Action										
1.	<p>Make sure that:</p> <ul style="list-style-type: none"> The location where the oven is being installed is rated to support the weight of the oven; The oven is within five feet (1.5 m) of the appropriate electrical outlet; You follow the oven clearance guidelines. 										
											
2.	<p>Move the oven to the installation location and onto the final resting surface. Apply the brakes of the front casters.</p>										
3.	<p>See topic <i>How to Clean the Oven</i>, and thoroughly clean the oven before continuing.</p>										
4.	<p>For ovens without plugs and cords, do the following (See topic <i>How to Connect the Electrical Wiring</i>).</p> <ol style="list-style-type: none"> Remove the top panel. Remove the cord grip that came with the oven from the restraint connector and insert it into the power connection hole. Connect the power wires to the terminal block and circuit breakers. Secure the cord with the cord grip. Tighten the cord grip nut. Re-install the top panel. <p>For ovens with plugs and cords, do the following.</p> <p>Plug the oven into a properly grounded receptacle.</p> <table border="1"> <thead> <tr> <th>NEMA 5-15P</th> <th>NEMA 5-20P</th> <th>CEE 7/7</th> <th>BS-1363</th> <th>CH2-16P</th> </tr> </thead> <tbody> <tr> <td></td> <td></td> <td></td> <td></td> <td></td> </tr> </tbody> </table>	NEMA 5-15P	NEMA 5-20P	CEE 7/7	BS-1363	CH2-16P					
NEMA 5-15P	NEMA 5-20P	CEE 7/7	BS-1363	CH2-16P							
											

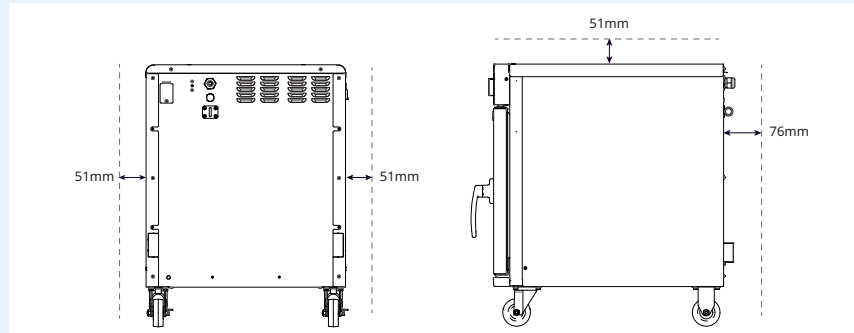

Connecting power

For ovens with plugs and cords, do the following.

Plug the oven into a properly grounded receptacle.

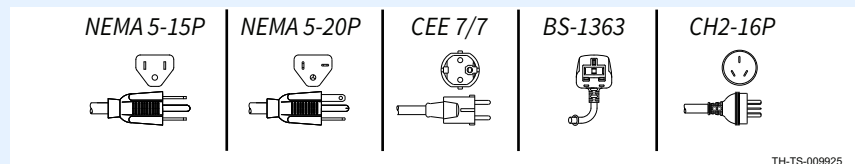

TH-TS-009925

Continued on next page

Continued from previous page

High limit reset

5. **Press and release** the high-limit temperature reset button ①.

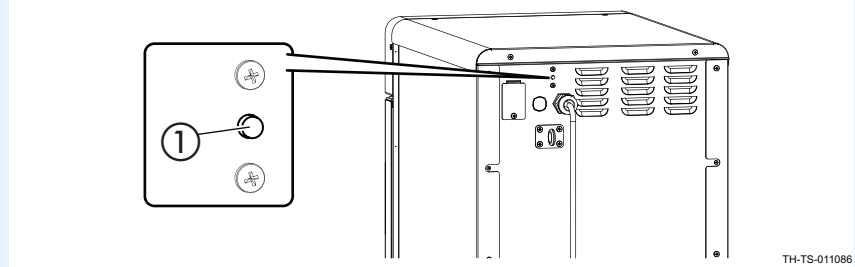

TH-TS-011086

Install the tether (if required)

6. For hard-wired ovens with casters, **install** the tether to the wall so that no stress is transmitted to the electrical cord when the oven moves.

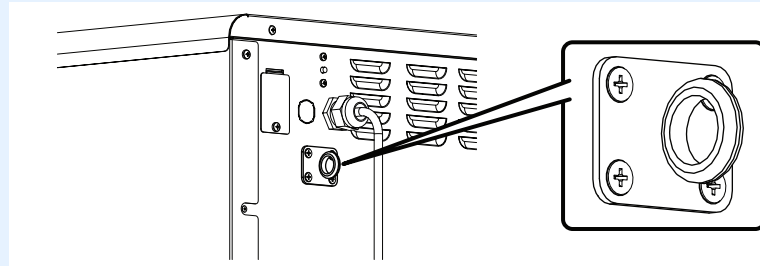

TH-TS-011090

Result

The oven is now installed.

How to Connect the Electrical Wiring

Before you begin

Make sure the power is off or disconnected at the supply.

Warnings



WARNING: Appliances without a cord provided by the factory must be equipped with a cord of sufficient length to permit the appliance to be moved for cleaning.

Always use the correct AWG wire size based on the electrical requirements for the appliance.



WARNING: To prevent serious injury, death, or property damage:

All electrical connections must be made by a qualified and trained service technician in accordance with applicable electrical codes.

This appliance must be adequately grounded in accordance with local electrical codes or, in the absence of local codes, with the current edition of the National Electrical Code ANSI/NFPA No 70. In Canada, all electrical connections are to be made in accordance with CSA C22 1, Canadian Electrical Code Part 1 or local codes.

CE-approved appliances include an equipotential-bonding terminal marked with the equipotential symbol. Provisions for earthing are to be made in accordance with IEC:2010 60335-1 section 27 or local codes.



CAUTION: Electrical shock hazard.

Power source must match voltage identified on appliance rating tag. The rating tag provides essential technical information required for any appliance installation, maintenance or repairs. Do not remove, damage or modify the rating tag.

Continued on next page

Continued from previous page

Procedure

To connect the electric power, do the following.

Step	Action
------	--------

1. **Remove** the top panel.

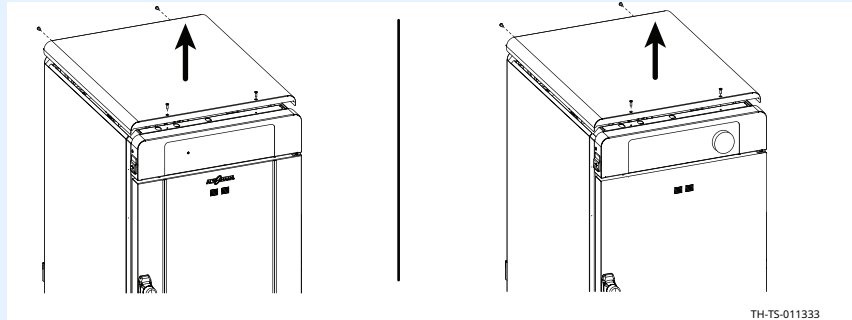

2. **Install** the cord grip into the back panel of the oven. **Install** the cord grip nut.

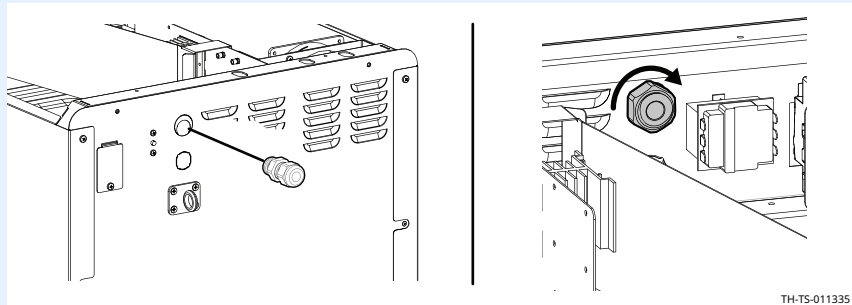

3. **Install** the cord through the cord grip. **Route** the ground wire to the terminal block.

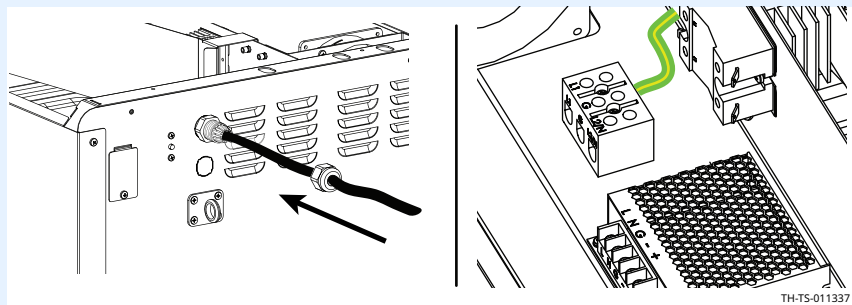

Continued on next page

Continued from previous page

4. **Remove** the screws retaining the circuit breakers ①. **Connect** the wires to the circuit breakers ②.

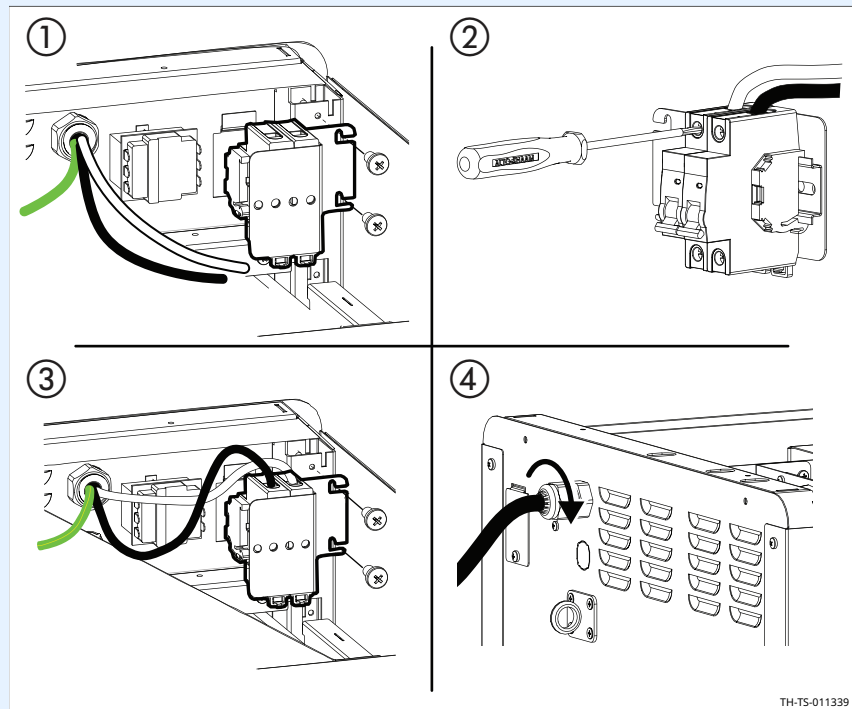

Re-install the circuit breakers with the screws ③.

Adjust the length of the cord. **Install** and tighten the cord grip nut ④.

5. **Re-install** the top panel.

Result

The electrical wiring is now connected.

How to Install the Drip Tray

Before you begin

Remove the drip tray from the oven cavity and remove any packaging.



WARNING: Slip Hazard

Failure to install the drip tray may result in moisture dripping on the floor. Be sure the drip tray is installed before using.

NOTICE

Failure to install the drip tray could result in equipment damage.

Procedure

To install the drip tray, do the following.

Step	Action
1.	Align the holes in the drip tray with the two studs located on the front of the oven.
2.	Hang the drip tray on the studs and press downward to lock it into place.

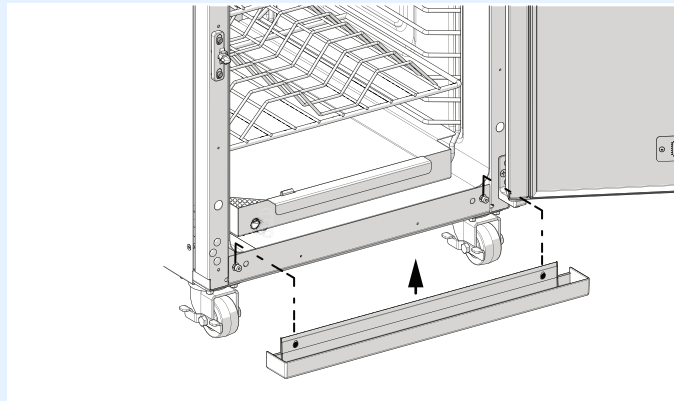

TH-TS-0009933

Result

The drip tray is installed.

How to Stack Two Ovens

Before you begin

Make sure you have:

- Industrial-grade silicone RTV
- An appropriate lifting device, and enough personnel, to safely move and position the weight of the oven.
 - 500-TH/SK: 185 lb (84 kg)
 - 750-TH/SK: 225 lb (102 kg)
 - 1000-TH/SK: 250 lb (113 kg)

Procedure

To stack the ovens, do the following.

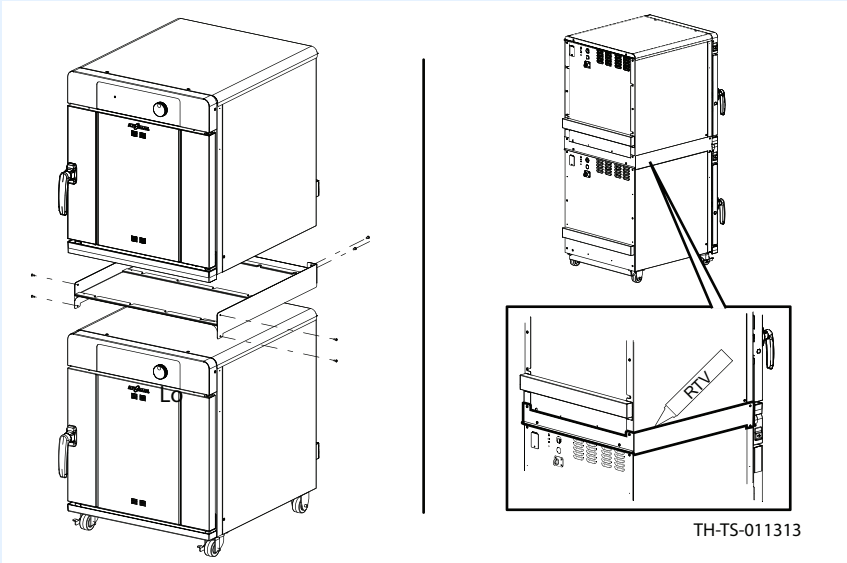
Step	Action
1.	Remove all packing material from each oven.
2.	Install the stacking kit to the bottom oven using the screws from the kit.
 <p style="text-align: right; margin-right: 50px;">TH-TS-011313</p>	
3.	Remove the casters from the upper oven if required.
4.	Using an appropriate lifting device, lift the upper oven and set it on the bottom oven. Secure the upper oven to the bottom oven using the screws from the kit. Apply a bead of silicone RTV on the three upper edges of the stacking kit.

Result

The ovens are now stacked.

Control Identification

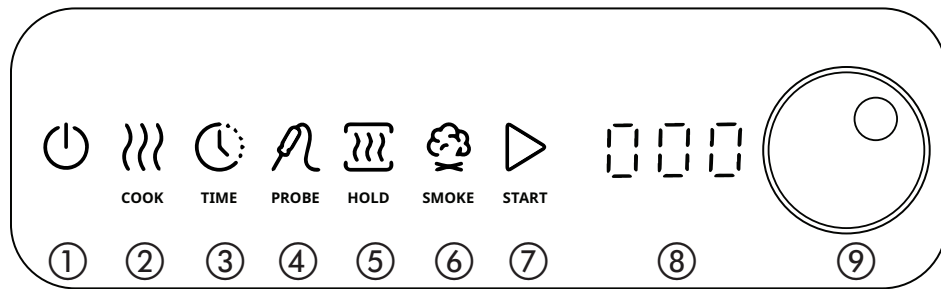

TH-TS-008703

Item	Description	Function
1	Power icon	Touch to turn on or turn off the oven.
2	Cook icon	Touch to set cook temperature.
3	Time icon	Touch to cook by time.
4	Probe icon	Touch to cook by probe.
5	Hold icon	Touch to set hold temperature.
6	Smoke icon (Ovens with smoker option only)	Touch to set smoke time.
7	Start icon	Touch to start cook, hold, or smoke function. Touch and hold to stop the current oven function.
8	LCD Display	Displays time, temperature, settings, and error codes.
9	Knob	Used to set or confirm time, temperature, or change settings. Press and hold to access the Settings menu.

How to Prepare the Oven for First Use

Background

Use this procedure for initial use or before using the oven after taking it out of storage.

Procedure

To prepare the oven for first use, do the following.

Step	Action
1.	Remove all packing material from the oven.
2.	Remove and wash detachable items such as wire racks, side racks, and drip pans. Wash these items with hot soapy water. Dry them with a clean, lint-free cloth.
3.	Remove visible grease or oil from the oven.
4.	Clean the interior and exterior of the oven with a mild soap and water solution. Dry with a clean, lint-free cloth.
5.	Clean the glass, if applicable, with glass cleaner or distilled vinegar.
6.	Re-install the wire racks, side racks, and drip pan.
7.	Turn on the oven and operate it without food for two hours at a temperature of 300°F (149°C) to remove surface oils and any accompanying odor.

Result

The oven is now ready for operation.

How to Use the Door Vents

Before you begin

The door vents provide ventilation for the oven cavities. The door vents can be adjusted to give you the best results for the food you are cooking.

Settings

To set the vents, use the following suggestions.

Cooking type	Vent position
General cooking	All half open
Smoking	All closed
To maintain moisture	All closed
To remove excess moisture	All open
To balance moisture	Lower closed, upper half open

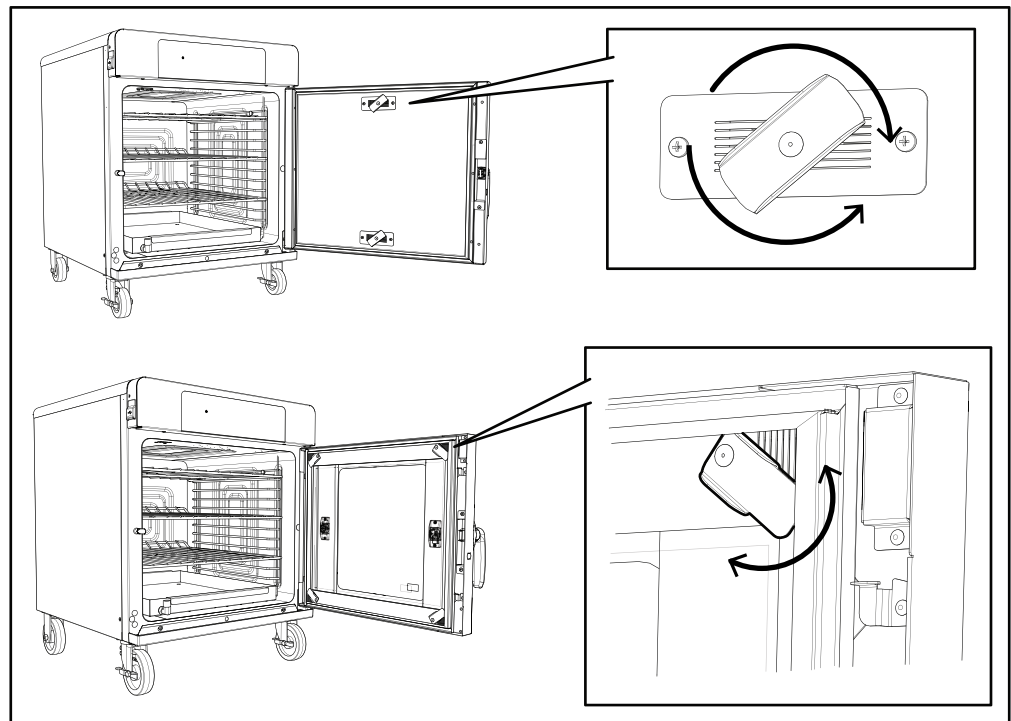

TH-TSK-011432

How to Turn On and Turn Off the Oven

Before you begin

The oven must be connected to electric power.

Turning the oven on or off

To turn on and off the oven, do the following.

Step	Action
1.	Touch the power icon ① to turn on the oven.
	
2.	Touch and hold the power icon ① for at least 5 seconds to turn off the oven.

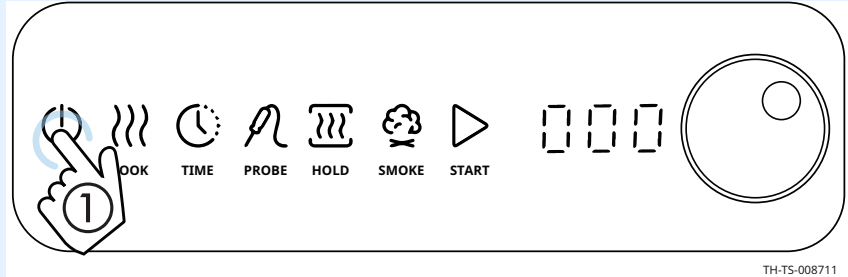

TH-TS-008711

Result

The oven is turned on or off.

How to Cook by Time (Optional Smoking)

Before you begin

Make sure:

- Your food is prepared and ready to cook
- If smoking, you have soaked the wood chips and loaded the wood chip tray. See topic *How to Prepare the Smoker Box for Smoking*.



WARNING: Fire hazard.

The use of improper materials for the smoke function could result in a fire which may lead to personal injury or property damage. Only use wood chips supplied by Alto-Shaam.

Soak the wood chips in water as instructed by National Fire Protection Agency Standard NFPA-96 or local codes prior to using them in the appliance.

Procedure

To cook by time, do the following.

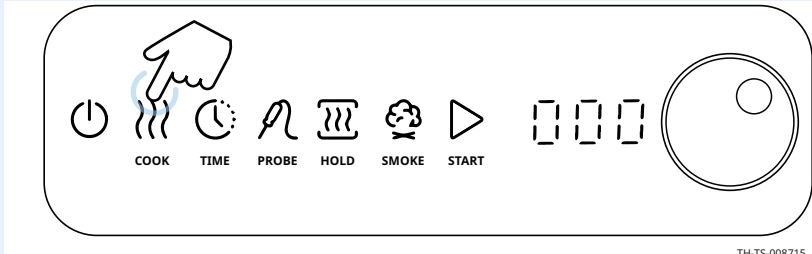
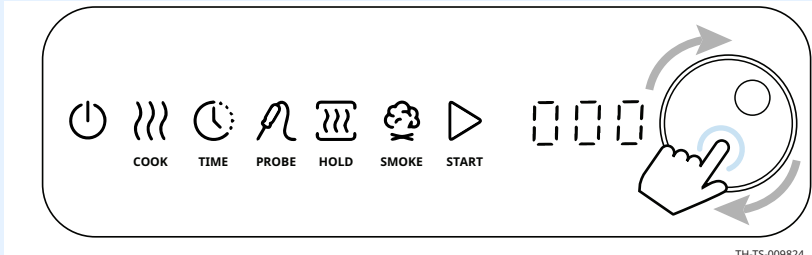
Step	Action
1.	<p>Touch the “COOK” icon.</p>  <p style="text-align: right;"><small>TH-TS-008715</small></p>
2.	<p>Turn the knob to set the cook temperature. Press the knob to confirm the cook temperature.</p>  <p style="text-align: right;"><small>TH-TS-009824</small></p>

Continued on next page

Continued from previous page

3. **Touch** the “TIME” icon.

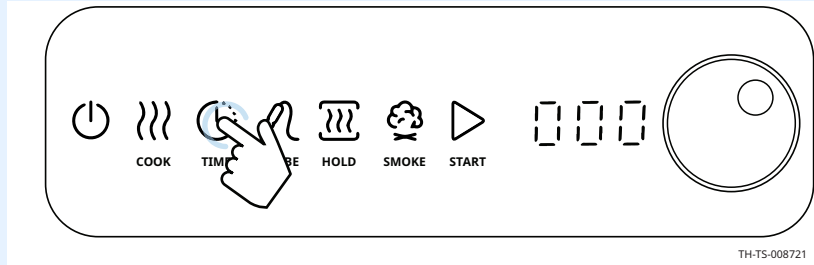

4. **Turn** the knob to set the cook time.
Press the knob to confirm the cook time.

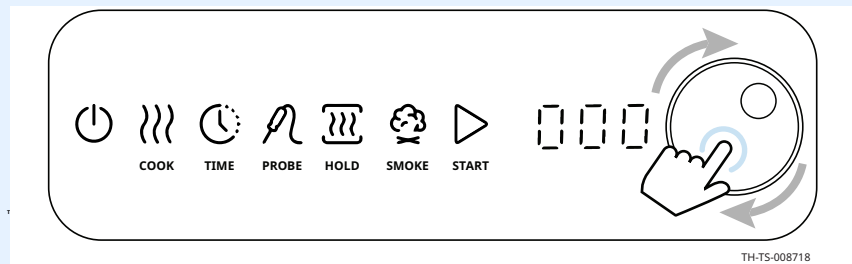

5. **Touch** the “HOLD” icon.

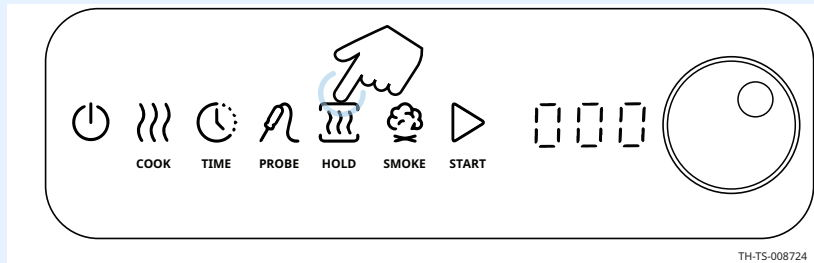

6. **Turn** the knob to set the hold temperature.
Press the knob to confirm the hold temperature.

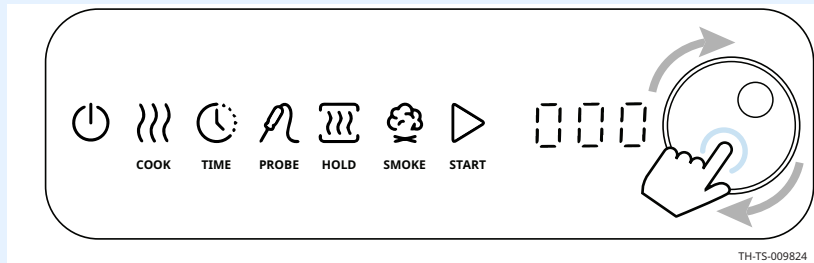

Continued on next page

Continued from previous page

Optional smoking

7. **Touch** the “SMOKE” icon (optional).

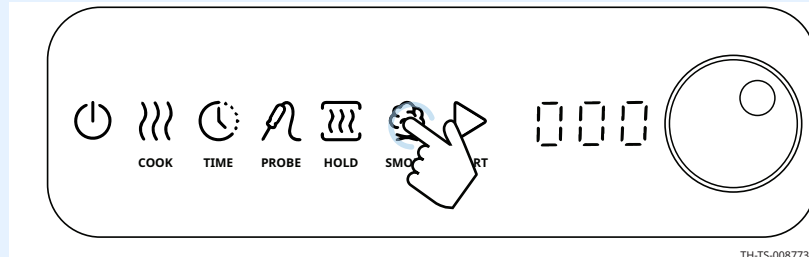

8. **Turn** the knob to set the smoke time (maximum smoke time 90 minutes).
Press the knob to confirm the smoke time.

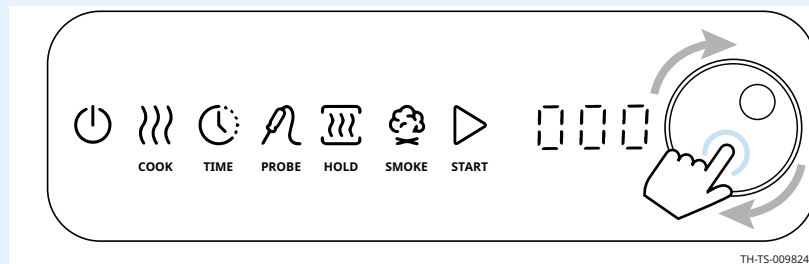

9. **Touch** the “START” icon.

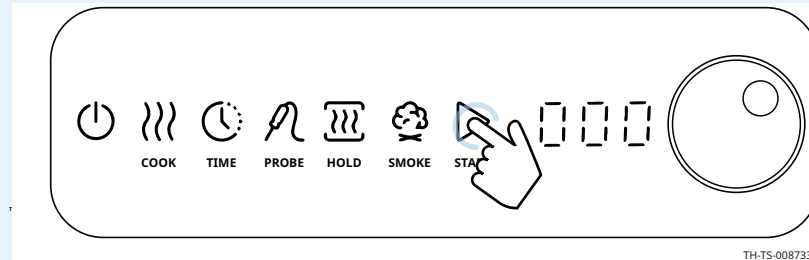

The control will display “Pre” and the actual cavity temperature.

When the oven reaches the set cook temperature, the control will display “Preheated”, and the “START” icon and the light around the knob will flash.

10. **Load** food into the oven and close the oven door.

Continued on next page

Continued from previous page

11. **Touch** the "START" icon.

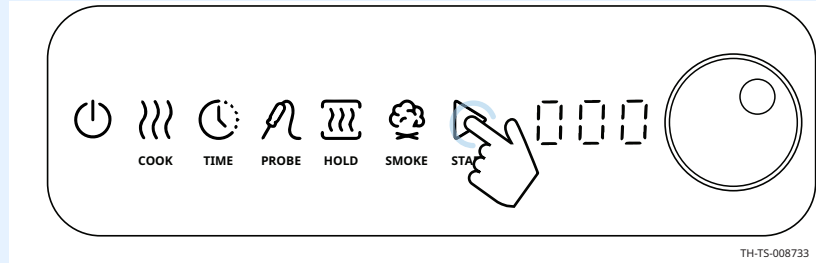

The cooking process will begin.

During the cooking process

After five (5) seconds, the control will display the set cook temperature and the time remaining in the cooking process.

- When cook time is reached, the oven will sound an alert, the "HOLD" icon will illuminate, and the oven will begin to hold at the set holding temperature.
- The control will display the set holding temperature and the amount of time the oven has been in the holding process.
- Touch the "COOK", "TIME", or "HOLD" icon, then touch the START icon for three (3) seconds at any time to cancel the cooking or holding process.

Result

The cook by time process is complete.

How to Cook by Probe

Before you begin

Make sure:

- Your food is prepared and ready to cook.
- If smoking, you have soaked the wood chips and loaded the wood chip tray. See topic *How to Prepare the Smoker Box for Smoking*.



WARNING: Fire hazard.

The use of improper materials for the smoke function could result in a fire which may lead to personal injury or property damage. Only use wood chips supplied by Alto-Shaam.

Soak the wood chips in water as instructed by National Fire Protection Agency Standard NFPA-96 or local codes prior to using them in the appliance.

Procedure

To cook by probe, do the following.

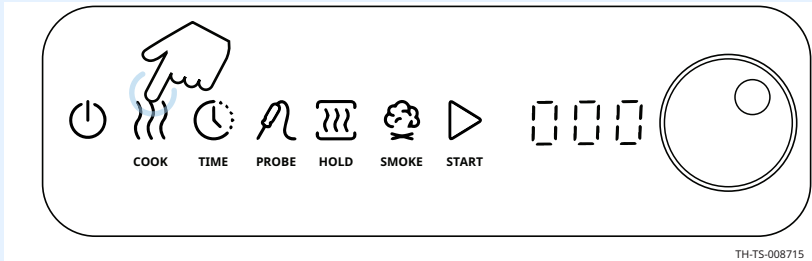
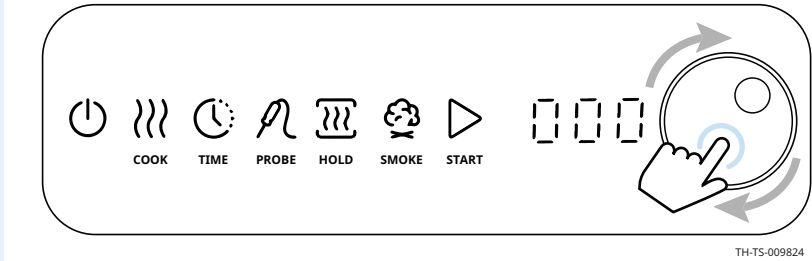
Step	Action
1.	<p>Touch the "COOK" icon.</p>  <p style="text-align: right;"><small>TH-TS-008715</small></p>
2.	<p>Turn the knob to set the cook temperature. Press the knob to confirm the cook temperature.</p>  <p style="text-align: right;"><small>TH-TS-009824</small></p>

Continued on next page

Continued from previous page

3. **Touch** the "PROBE" icon.

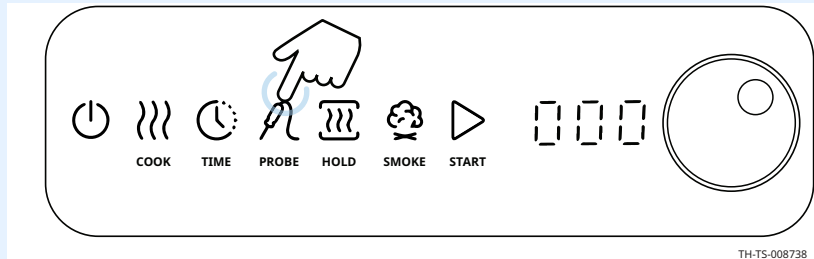

TH-TS-008738

4. **Turn** the knob to set the probe set temperature.
Press the knob to confirm the probe set temperature.



TH-TS-009824

5. **Touch** the "HOLD" icon.

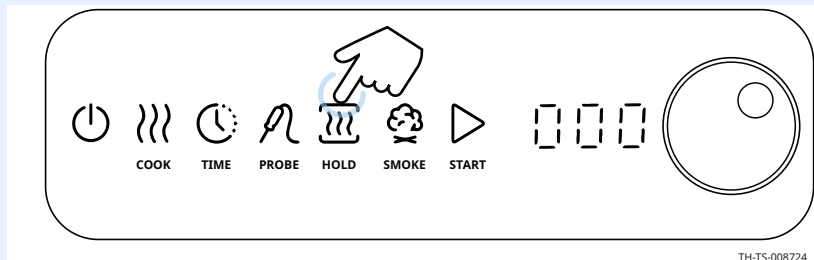

TH-TS-008724

6. **Touch** the "PROBE" icon.

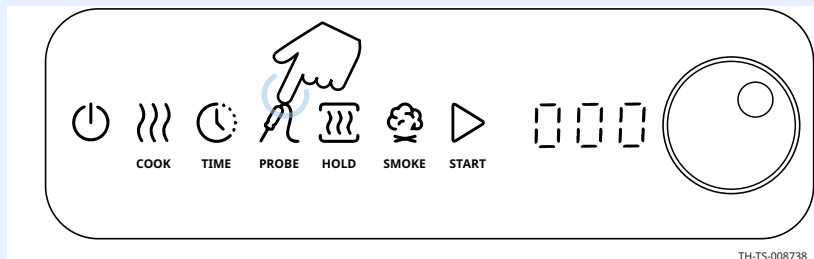

TH-TS-008738

Continued on next page

Continued from previous page

7. **Turn** the knob to set the probe hold temperature.
Press the knob to confirm the probe hold temperature.

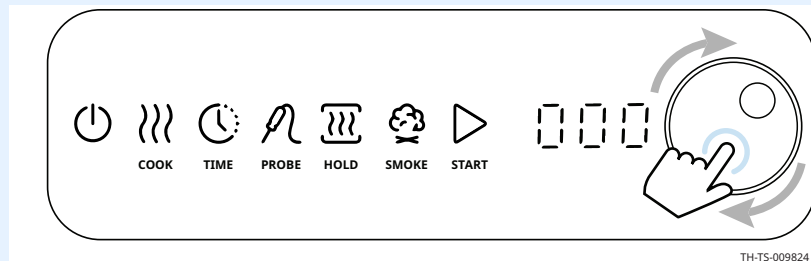

TH-TS-009824

8. **Touch** the "SMOKE" icon (optional).

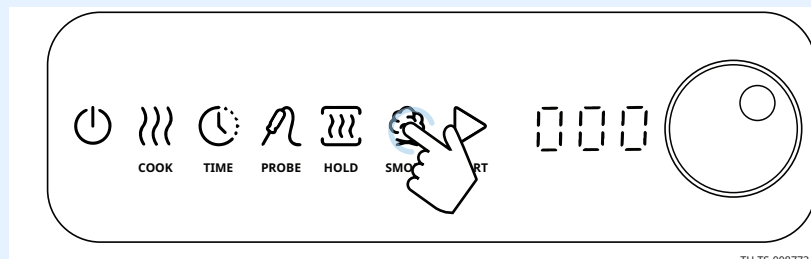

TH-TS-008773

9. **Turn** the knob to set the smoke time (maximum smoke time 90 minutes).
Press the knob to confirm the smoke time.

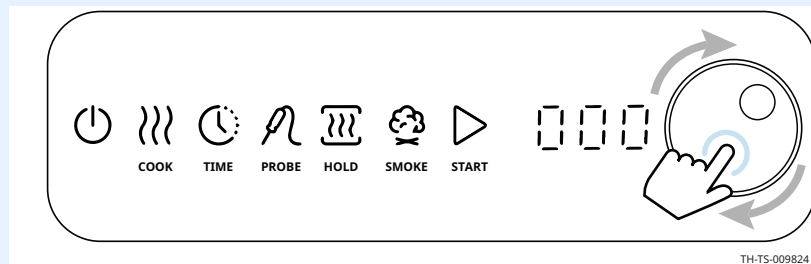

TH-TS-009824

Continued on next page

Continued from previous page

10. **Touch** the “START” icon.

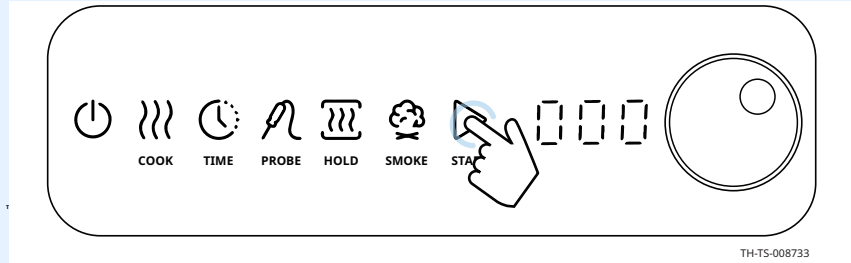

The control will display “Pre” and the actual cavity temperature.

When the oven reaches the set preheat temperature, the control will display “Preheated”, and the “START” icon will flash.

11. **Load** wood chip tray into the oven.

Load food into the oven.

Insert probe into food and plug probe into the receptacle.

Touch the “START” icon.

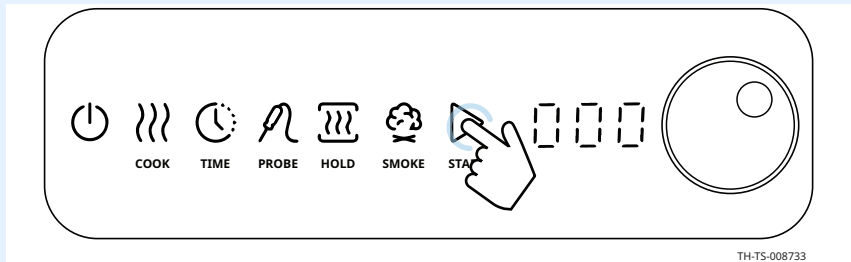

The oven begins to cook by probe.

The control will display the set temperature and the probe temperature.

Holding process

- When the set probe temperature is reached, the oven will sound an alert, the HOLD icon will illuminate, and the oven will begin to hold at the set probe holding temperature.
- The control will display the set holding temperature and the amount of time the oven has been in the holding process.
- Touch the “COOK”, “TIME”, “PROBE”, or “HOLD” icon, then hold the “PROBE” icon to view the probe temperatures.
- Touch the “COOK”, “TIME”, “PROBE”, or “HOLD” icon, then touch the START icon for three (3) seconds at any time to cancel the cooking or holding process.

Result

The cook by probe process is complete.

How to Hold at a Set Temperature

Before you begin

Make sure food to be put into the oven is 140°F (60°C) to 160°F (71°C).

Procedure

To hold at a set temperature, do the following.

Step	Action
1.	<p>Touch the “HOLD” icon.</p> <p>The oven defaults to the last hold temperature.</p> 
2.	<p>Turn the knob to set the hold temperature.</p> <p>Press the knob to confirm the hold temperature.</p> 
<p>Touch “START” icon.</p> <p>Allow oven to reach the set temperature.</p> <div style="border: 1px solid black; padding: 5px; margin: 10px 0;"> <p>NOTE: Press and hold the “HOLD” icon to view the actual cavity temperature.</p> </div>	
3.	<p>Load hot food into the oven and close the oven door.</p> <p>The oven begins to hold at the set temperature.</p>

1. **Touch** the “HOLD” icon.

The oven defaults to the last hold temperature.

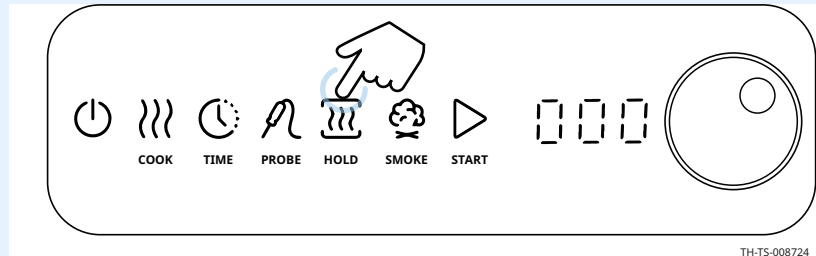

TH-TS-008724

2. **Turn** the knob to set the hold temperature.

Press the knob to confirm the hold temperature.

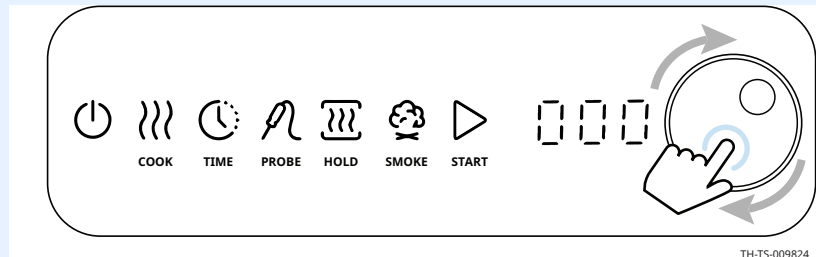

TH-TS-009824

Touch “START” icon.

Allow oven to reach the set temperature.



NOTE: Press and hold the “HOLD” icon to view the actual cavity temperature.

3. **Load** hot food into the oven and close the oven door.

The oven begins to hold at the set temperature.

During the holding process

The control will display the hold temperature and the amount of time the oven has been holding at the set temperature.

Touch the “HOLD” icon, then touch the START icon for three (3) seconds at any time to cancel the cooking or holding process.

Result

The oven is holding at the set temperature.

How to Prepare the Smoker Box for Smoking

Before you begin

- Use only wood chips supplied by Alto-Shaam.
- Clean the smoker box of used wood chips. Dispose of the burnt wood chips as directed by local codes.

Procedure

To prepare the smoker box for smoking, do the following.



WARNING: Fire hazard.

The use of improper materials for the smoke function can result in a fire which may lead to personal injury or property damage.

Only use wood chips supplied by Alto-Shaam.

Step	Action
1.	<p>Soak the wood chips in the clean water as instructed by National Fire Protection Agency Standard NFPA-96 or local codes. As of 2021, the NFPA-96 standard calls for a soaking period of 24 hours.</p> <div style="border: 1px solid orange; padding: 5px; margin-top: 10px;">  <p>WARNING: Fire hazard. Soaking the wood chips in anything besides clean water may lead to personal injury or property damage. Only soak the wood chips in clean water.</p> </div>
2.	<p>Shake off excess water and place the moistened chips in the smoker box. Close the smoker box lid.</p>
3.	<p>Slide the smoker box over the smoker element so that it rests in the cradle.</p> <div style="display: flex; justify-content: space-around; align-items: center;">   </div> <p style="text-align: right; font-size: small;">TH-TS-011284</p>

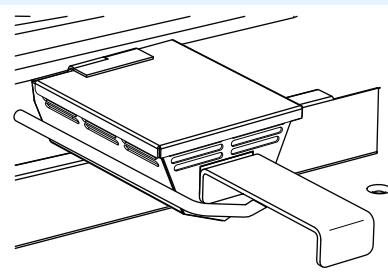
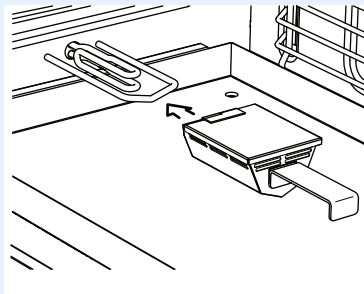

TH-TS-011284

Result

The smoker box is now prepared for smoking.

How to Cold Smoke

Before you begin

Make sure:

- Your food is prepared and ready to smoke.
- You have soaked the wood chips. See topic *How to Prepare the Smoker Box for Smoking*.





WARNING: Fire hazard.

The use of improper materials for the smoke function could result in a fire which may lead to personal injury or property damage. Only use wood chips supplied by Alto-Shaam.

Soak the wood chips in water as instructed by National Fire Protection Agency Standard NFPA-96 or local codes prior to using them in the appliance.

Procedure

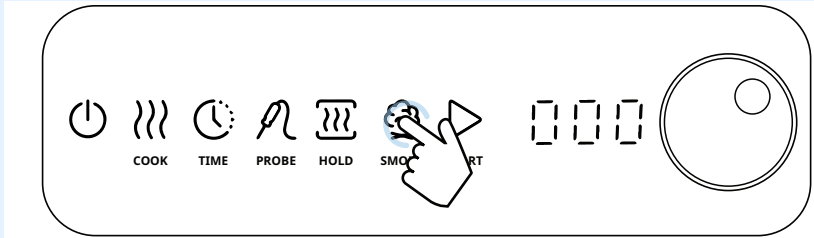
To cold smoke, do the following.

Step	Action
1.	<p>Load the chip tray with wood chips, then load it into the oven.</p> <p>Load a pan filled with ice into the oven.</p> <p>Load the food into the oven.</p>
2.	<p>Touch the “SMOKE” icon.</p>  <p style="text-align: right;"><small>TH-TS-008773</small></p>
3.	<p>Turn the knob to set the smoke time (maximum smoke time 90 minutes).</p> <p>Press the knob to confirm the smoke time.</p>  <p style="text-align: right;"><small>TH-TS-009824</small></p>

Continued on next page

Continued from previous page

4. **Touch** the “PROBE” icon (optional).

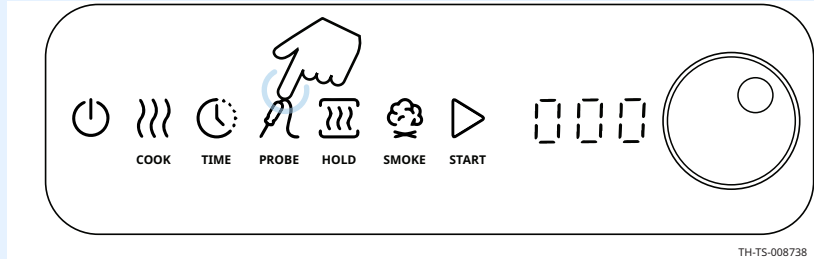

5. **Turn** the knob to set the probe alarm temperature.
Press the knob to confirm the probe alarm temperature.

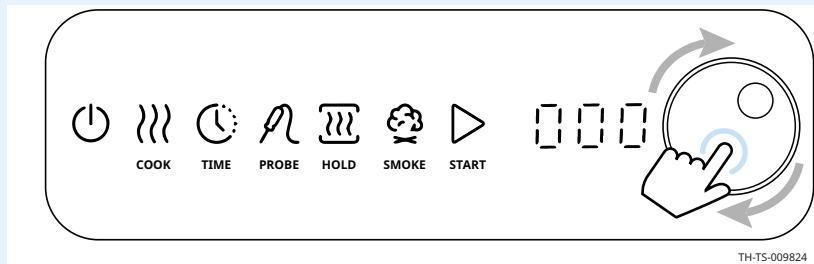

6. **Insert** probe into food and plug probe into the receptacle.

i **NOTE:** If the probe reaches the alarm temperature, the controller will sound an alert. Remove the food from the oven.

7. **Touch** the “START” icon.

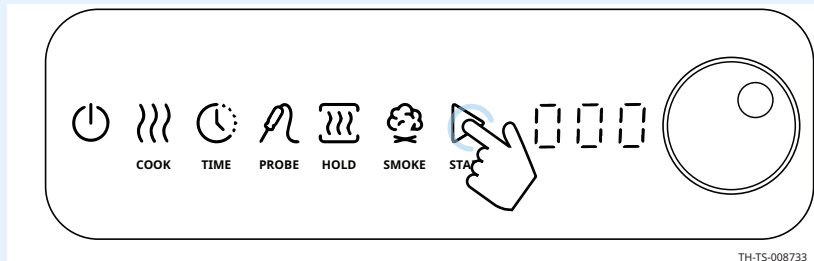

Result

The oven is cold smoking.

How to Load Recipes from a USB Drive

Before you begin

You will need a USB drive loaded with recipes.

NOTE: Uploaded recipes will overwrite any saved or previously uploaded recipes.

Procedure

To load recipes from the USB drive to the oven, do the following.

Step	Action
1.	Plug the USB drive into the port ①.
2.	Press and hold the knob to access the settings menu.
3.	Turn the knob until the control displays “USB”. Press the knob to access the USB menu.

1. **Plug** the USB drive into the port ①.

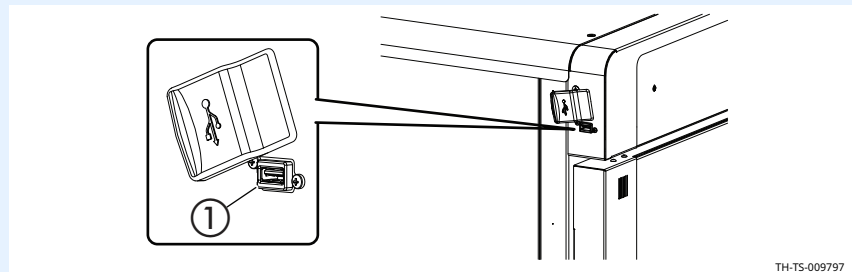

2. **Press** and hold the knob to access the settings menu.

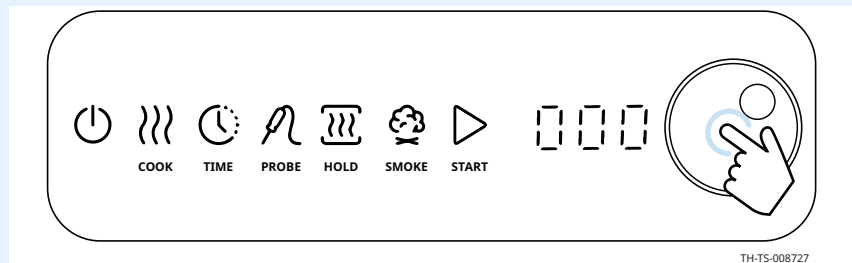

3. **Turn** the knob until the control displays “USB”.
Press the knob to access the USB menu.

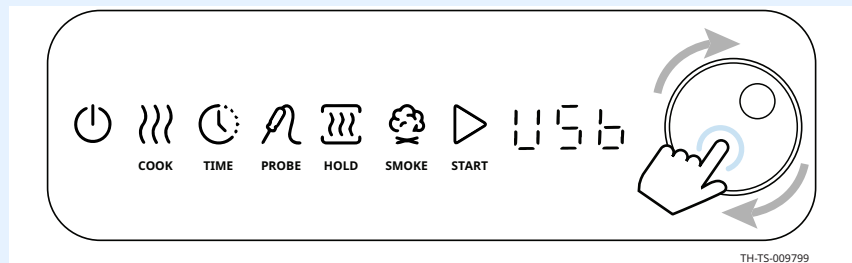

Continued on next page

Continued from previous page

4. **Turn** the knob until the control displays “Load”.
Press the knob to select “Load”.

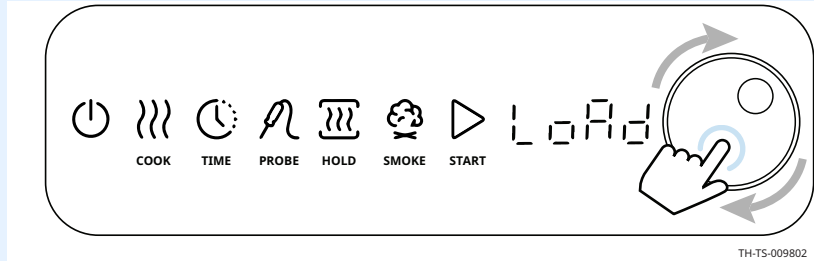

5. **Turn** the knob to “yes”.
Press the knob to select “yes” and begin the upload.

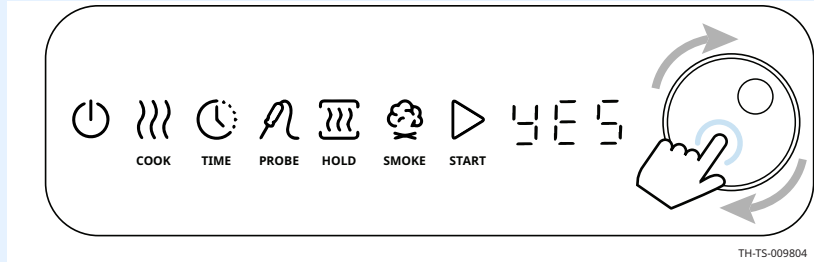

The control will display “done” when the files have been uploaded.

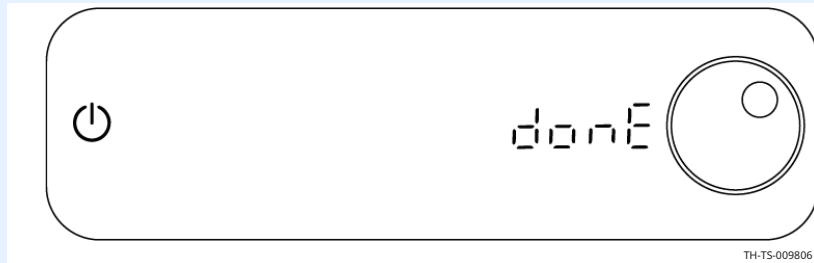

6. **Remove** the USB drive.

Result

The recipes are now loaded.

How to Save Recipes to a USB Drive

Before you begin

You will need a USB drive.

Procedure

To save recipes from the oven to a USB drive, do the following.

Step	Action
1.	Plug the USB drive into the port ①.
2.	Press and hold the knob to access the settings menu.
3.	Turn the knob until the control displays "USB". Press the knob to access the USB menu.

1. **Plug** the USB drive into the port ①.

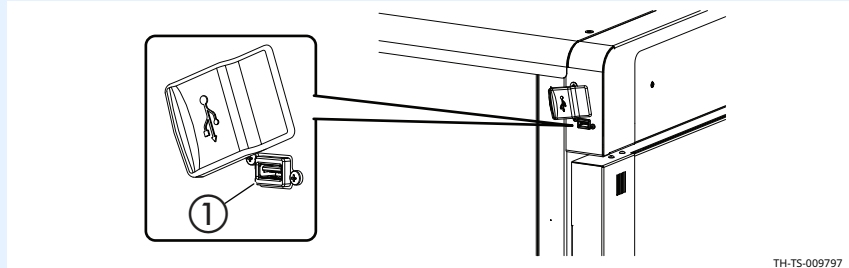

2. **Press** and hold the knob to access the settings menu.

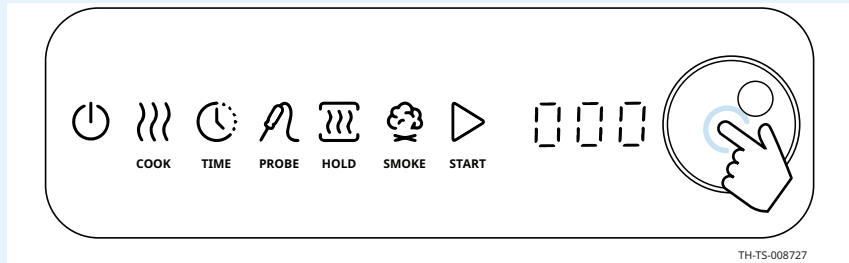

3. **Turn** the knob until the control displays "USB".
Press the knob to access the USB menu.

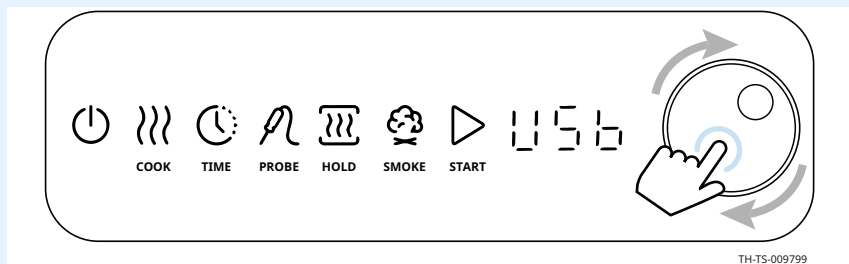

Continued on next page

Continued from previous page

4. **Turn** the knob until the control displays “Stor”.
Press the knob to select “Stor”.

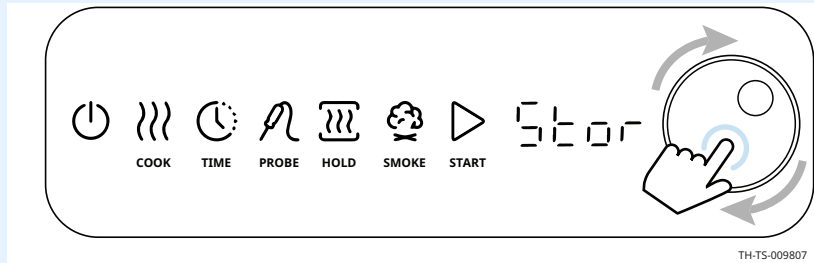

5. **Turn** the knob to “yes”.
Press the knob to select “yes” and begin the download.

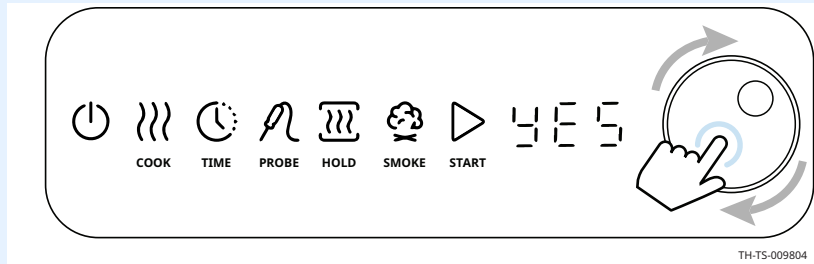

The control will display “done” when the files have been downloaded.

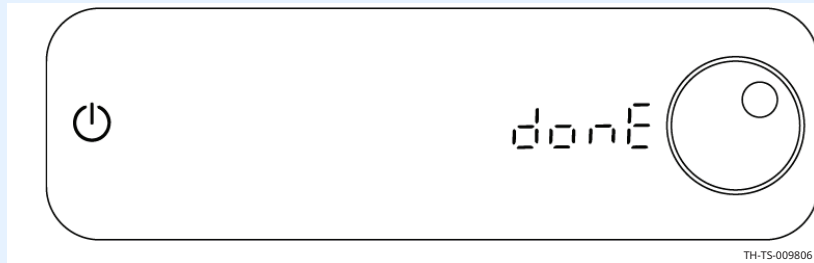

6. **Remove** the USB drive.

Result

The recipes have been saved to the USB drive.



How to Create and Store a Recipe

Before you begin

Make sure you have read the *How to Cook* topics in this manual.

Procedure

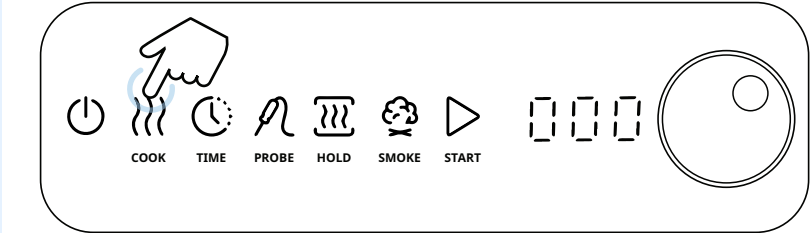
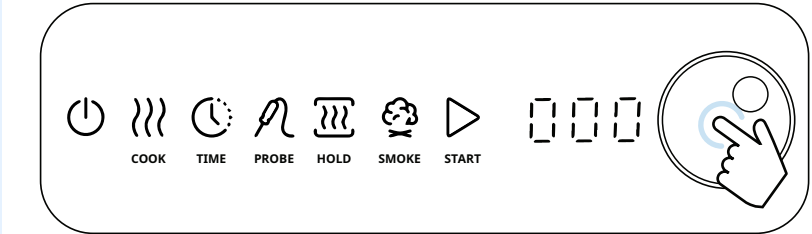
To create and store a recipe to the oven, do the following.

Step	Action
1.	<p>Enter Cook, Hold, Smoke settings, but do not press "START".</p>  <p>TH-TS-008715</p>
2.	<p>Press and hold the knob to access the settings menu.</p>  <p>TH-TS-008727</p>
3.	<p>Turn the knob until the control displays "Stor".</p> <p>Press the knob to select "Stor".</p>  <p>TH-TS-009820</p>

Continued on next page

Continued from previous page

- The controller can store up to eight (8) recipes. **Turn** the knob to the desired number for the recipe: 1 through 8.

Press the knob to select recipe 1 through 8.

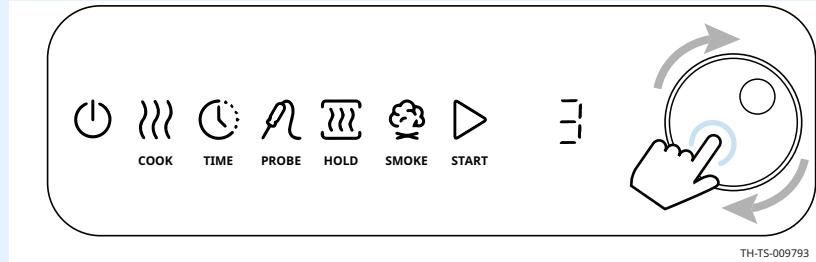

TH-TS-009793

- On double cavity ovens only, **turn** the knob to select the cavity to save the recipe to (top, bottom, or both).

Press the knob to select the cavity.

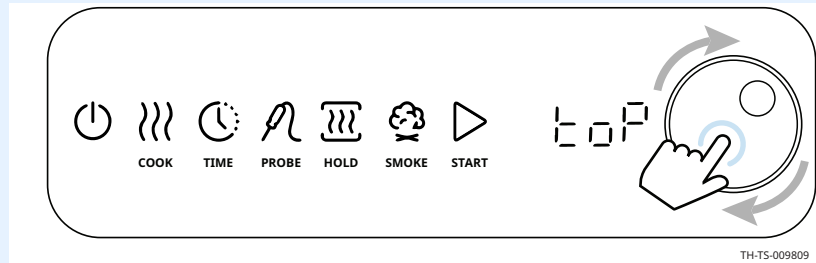

TH-TS-009809

The control will display "done" when the recipe has been stored.

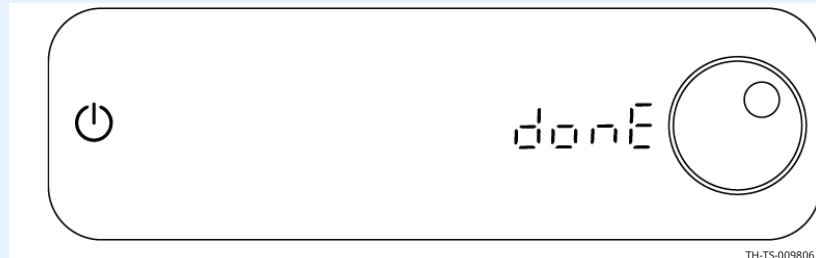

TH-TS-009806

Result

A recipe has been created and stored to the oven.

How to Cook Using a Recipe

Before you begin

Program a recipe, or upload a recipe from a USB drive.

The oven is preprogrammed with eight (8) identical recipes. The recipes can be retained or overwritten.

Preheat temperature	250°F (121°C)
Cook temperature	250°F
Cook time	2 hours
Hold temperature	140°F (60°C)
Smoke time (if applicable)	1 hour

Procedure

To cook with a saved recipe, do the following.

Step	Action
------	--------

1. **Press** and hold the knob to access the settings menu.

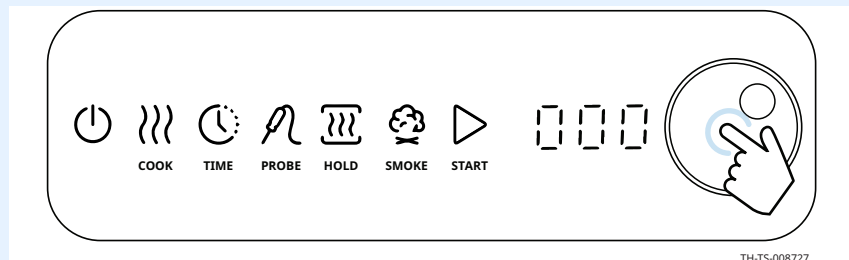

TH-TS-008727

2. **Turn** the knob until the control displays "LOAD".



TH-TS-009822

Continued on next page

Continued from previous page

3. **Turn** the knob to the desired recipe number: 1 through 8.
Press the knob to select a recipe number.



TH-TS-009793

The control will briefly display the recipe settings.

4. On double cavity ovens only, **turn** the knob to choose the cavity you want to use (top, bottom, or both).
Press the knob to select the cavity or cavities.



TH-TS-009811

5. **Touch** the "START" icon when it flashes.

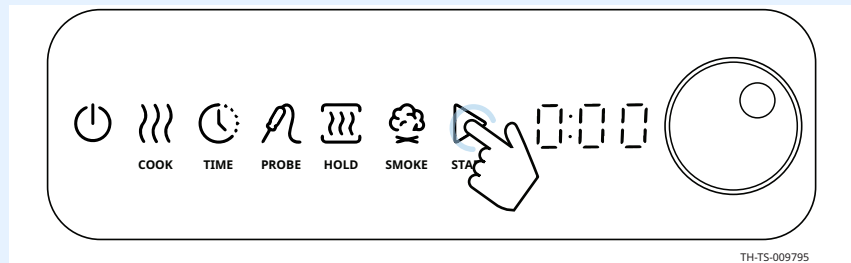

TH-TS-009795

Result

The oven is cooking using a recipe.

How to Turn on or Turn off the Alert Function

Before you begin

Make sure the oven is turned on, but is not in cooking or holding mode.

Procedure

To turn on or turn off the alert function, do the following.

Step	Action
1.	Press and hold the knob to access the settings menu.
2.	Turn the knob until the word “beep” shows on the display. Press the knob to select “beep”.
3.	Turn the knob until “yes” for alert function on, or “no” for alert function off, shows on the display. Press and hold the knob to select “yes” or “no”.

1. **Press** and hold the knob to access the settings menu.

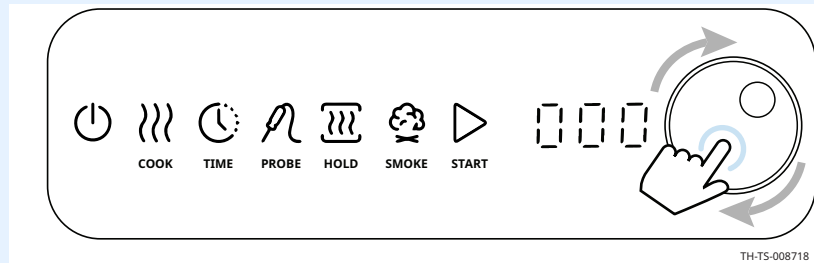

2. **Turn** the knob until the word “beep” shows on the display.
Press the knob to select “beep”.

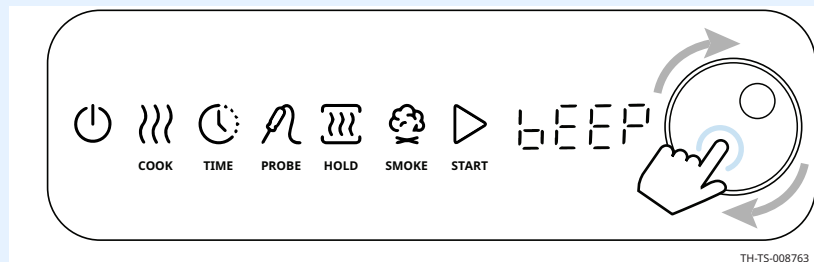

3. **Turn** the knob until “yes” for alert function on, or “no” for alert function off, shows on the display.
Press and hold the knob to select “yes” or “no”.

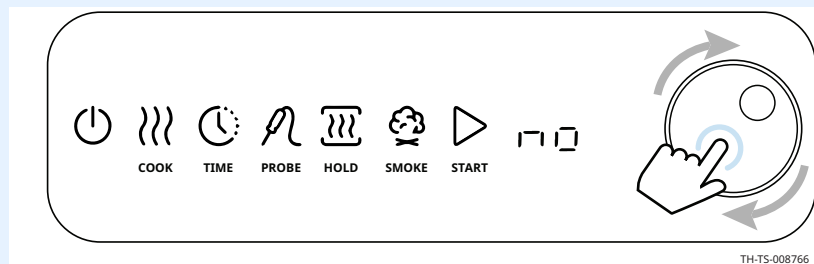

Result

The alert function is now turned on or turned off.

How to Lock and Unlock the Controller

Procedure

To lock and unlock the controller, do the following.

Step	Action
1.	To lock the controller, press and while holding the knob, touch the power icon.
	 <p style="text-align: right; font-size: small;">TH-TS-011328</p>
	<p>NOTE: The controller will sound an alert if it is locked and the user touches an icon.</p>
2.	Repeat the process to unlock the controller.

Result

The controller has now been locked or unlocked.

How to Change the Temperature Scale

Before you begin

Make sure the oven is turned on, but is not in cooking or holding mode.

Procedure

To change the temperature scale, do the following.

Step	Action
1.	Press and hold the knob to access the settings menu.
2.	Turn the knob until the control displays "F or C".
3.	Turn the knob until the "F" for Fahrenheit, or "C" for Celsius displays. Press and hold the knob to select "F" or "C".

1. **Press** and hold the knob to access the settings menu.



2. **Turn** the knob until the control displays "F or C".



3. **Turn** the knob until the "F" for Fahrenheit, or "C" for Celsius displays.
Press and hold the knob to select "F" or "C".



Result

The temperature scale is now changed.

How to Calibrate the Temperature Probe

Before you begin

Make sure:

- The oven is on, but not in cooking or holding mode.
- You have a container filled with ice water.

Procedure

To calibrate the probe, do the following.

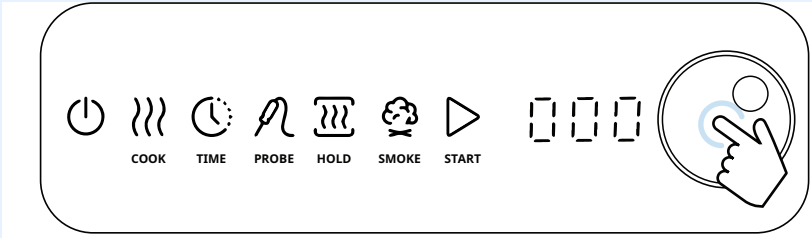
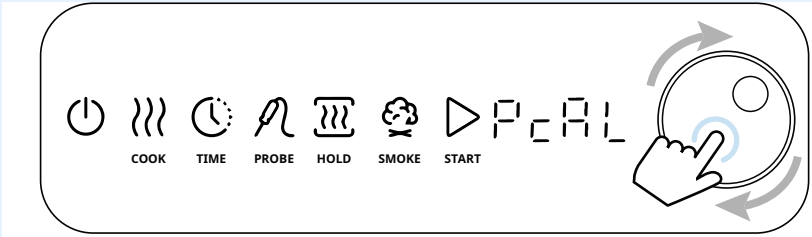
Step	Action
1.	Place the probe and thermometer in the container of ice water and allow the temperature to settle to 32°F (0°C).
2.	<p>Press and hold the knob to access the settings menu.</p>  <p style="text-align: right; font-size: small;">TH-TS-008727</p>
3.	<p>Turn the knob until the control displays PCAL.</p> <p>Press the knob to access the PCAL menu.</p>  <p style="text-align: right; font-size: small;">TH-TS-011322</p>

Continued on next page

Continued from previous page

4. If the display does not show 32°F (0°C), **turn** the knob until the control displays 32°F (0°C).

Press the knob to enter the temperature.

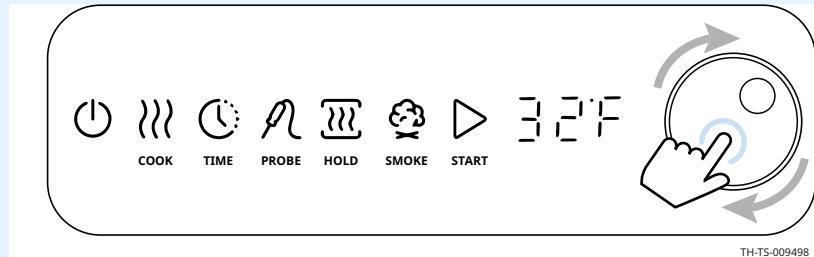

5. **Remove** the probe from the ice water.

Result

The probe is now calibrated.

How to Update Software with a USB Drive

Before you begin

- You will need a USB drive loaded with the software update.
- Make sure the oven is on, but is not in cooking or holding mode.
- Record the versions of the software loaded to the oven. See topic *How to View the Software Versions*.

Procedure

To update the software, do the following.

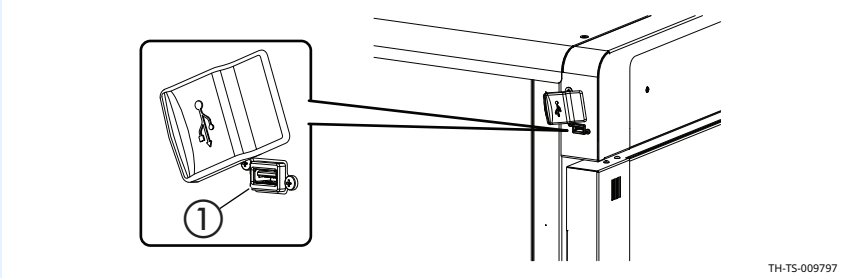
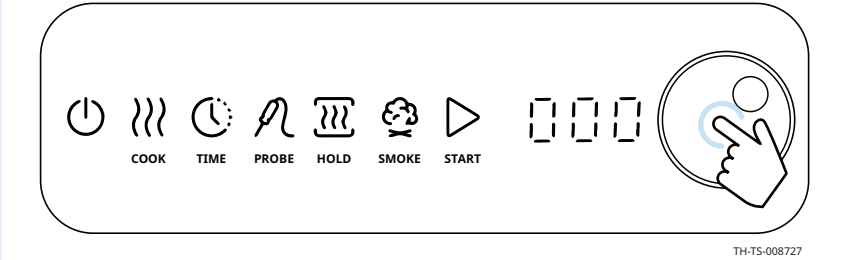
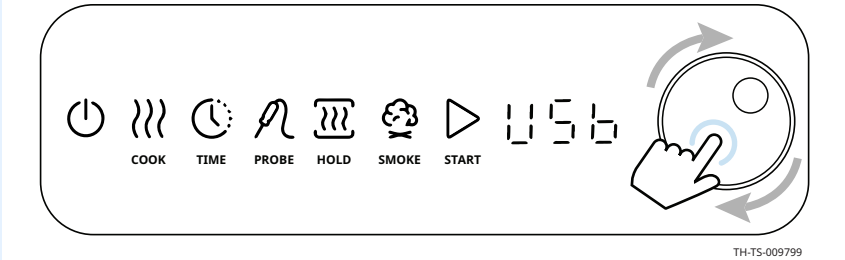
Step	Action
1.	<p>Plug the USB drive into the port ①.</p>  <p style="text-align: right; font-size: small;">TH-TS-009797</p>
2.	<p>Press and hold the knob to access the settings menu.</p>  <p style="text-align: right; font-size: small;">TH-TS-008727</p>
3.	<p>Turn the knob until the control displays USB.</p> <p>Press the knob to access the USB menu.</p>  <p style="text-align: right; font-size: small;">TH-TS-009799</p>

Continued on next page

Continued from previous page

4. **Turn** the knob until the control displays “Prog”.

Press the knob to select “Prog”.

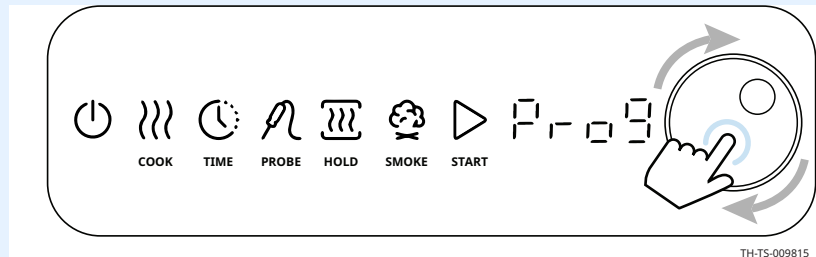

5. **Turn** the knob to “yes”.

Press the knob to select “yes” and begin the update.

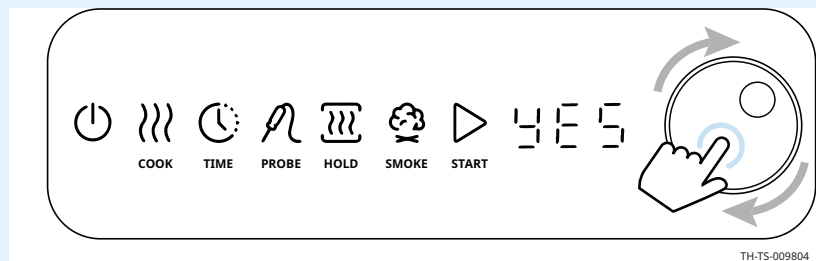

The START icon will display. The light around the knob will flash. The display will go blank for several seconds. The interface board (IB) software version displays. The control board (CB) software version displays. Record this number.

Continued on next page

Continued from previous page

6. The interface board (IB) software version displays.

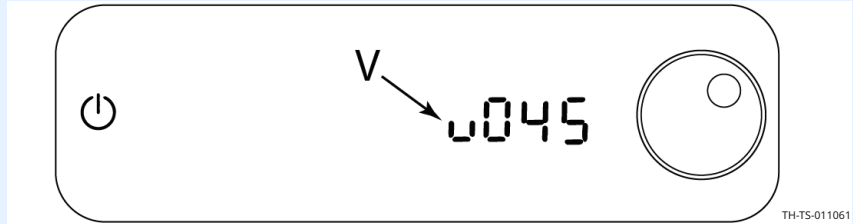

The control board (CB) software version displays. The numbers to the left of the colon ":" display in HEX format. Record this number.

NOTE: A CB version of 1.11 would be represented as 1:11, while a version of 111.11 would be represented as 6F:11. The numbers to the right of the colon ":" are not in HEX format.

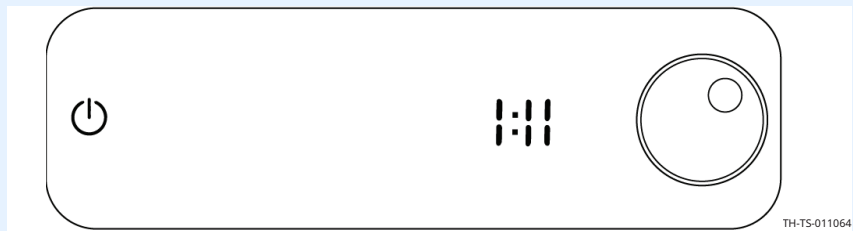

7. Power failure (PF) displays.

Touch the power icon to clear the power failure (PF).

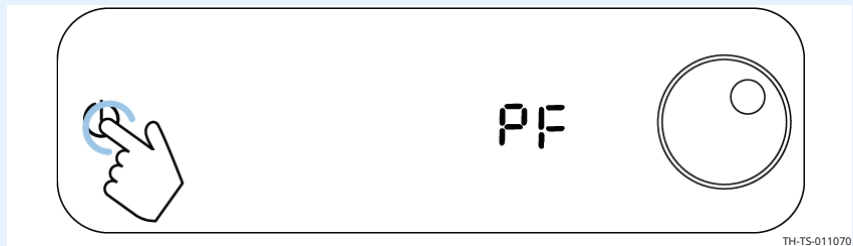

Continued on next page

Continued from previous page

8. The display will go blank. **Touch** the power icon.

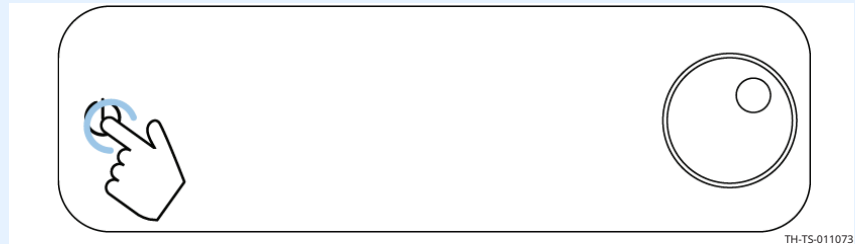

The display will power up and the icons display.

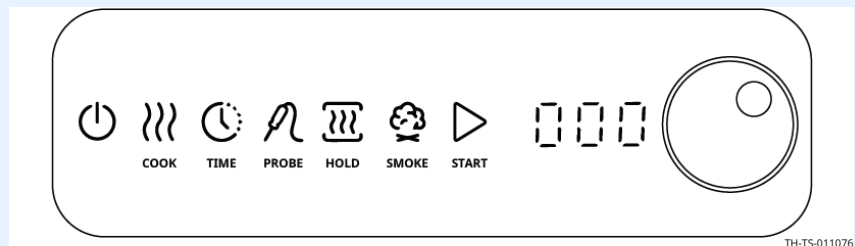

9. **Remove** the USB drive.

Result

The software has been updated.

As an alternative to using the “Prog” function, software can also be updated by doing the following:

- Turn off the breaker on the back, or unplug the oven.
- Plug the USB drive into the port on the side of the oven.
- Turn on the breaker on the back, or plug the oven back in.



The software will update automatically.

Do not remove the USB drive until the update is complete.

How to View the Software Versions

Procedure

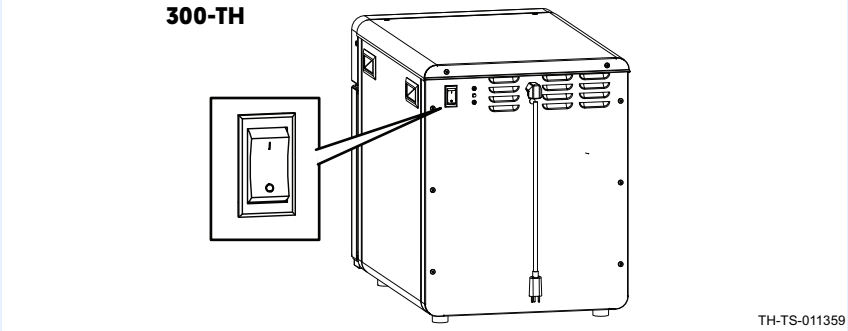
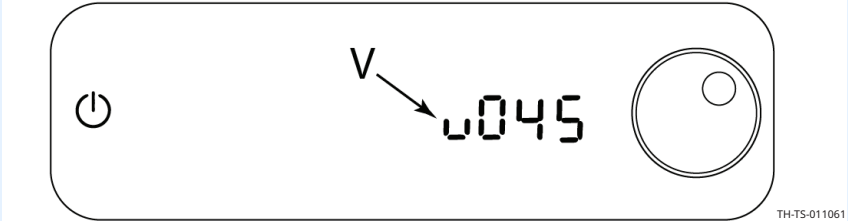
To view the software versions, do the following.

Step	Action
1.	<p>Remove and reapply electrical power from the oven.</p> <p>NOTE: For TH-300 ovens, the power switch can be used.</p>  <p style="text-align: right;">TH-TS-011359</p>
2.	<p>The interface board (IB) software version displays. Record this number.</p>  <p style="text-align: right;">TH-TS-011061</p> <p>The control board (CB) software version displays. The numbers to the left of the colon ":" display in HEX format. Record this number.</p> <p>NOTE: A CB version of 1.11 would be represented as 1:11, while a version of 111.11 would be represented as 6F:11. The numbers to the right of the colon ":" are not in HEX format.</p>  <p style="text-align: right;">TH-TS-011064</p>

Continued on next page

Continued from previous page

3. Power failure (PF) displays.

Touch the power icon to clear the power failure (PF).

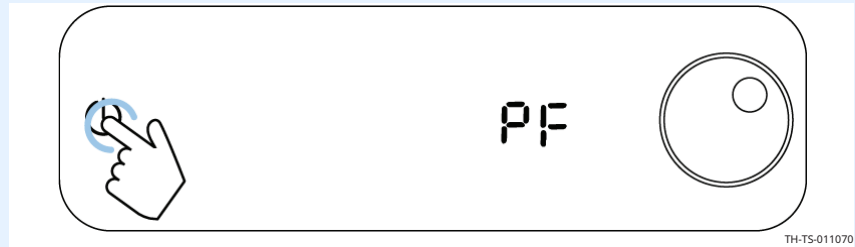

4. The display will go blank. **Touch** the power icon.

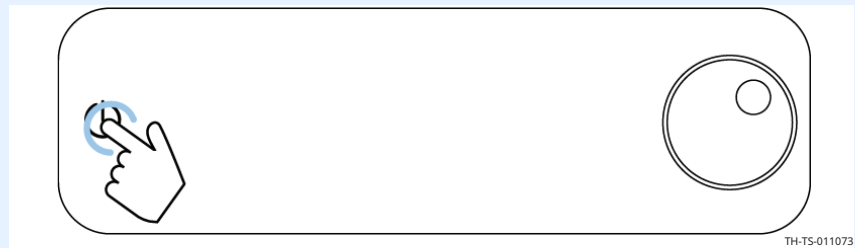

The display will power up and the icons display.

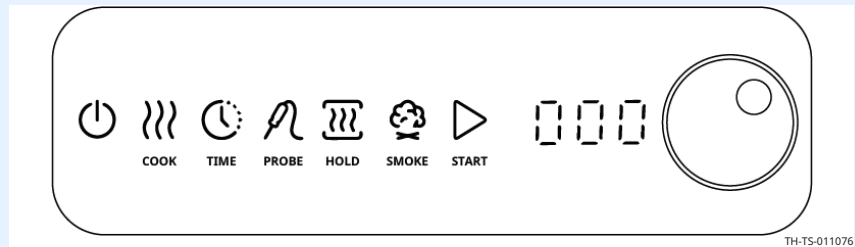

Result

The software versions have now been viewed.

How to Set the Date and Time for HACCP Data (if equipped)

Before you begin

Make sure the HACCP option is enabled. The “DATE” option is available in the settings menu.

Procedure

To set the date and time for HACCP data, do the following.

Step	Action
------	--------

1. **Press** and hold the knob to access the settings menu.

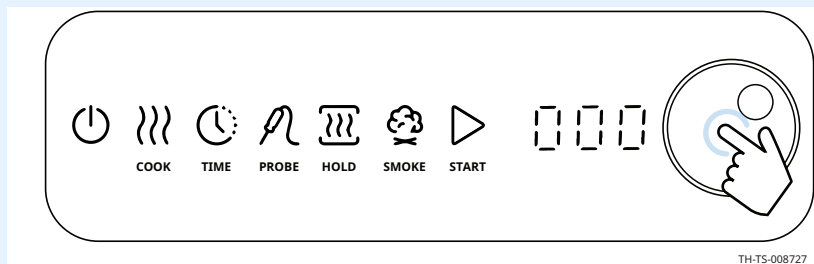

2. **Turn** the knob until the control displays “date”.
Press the knob to access the date menu.

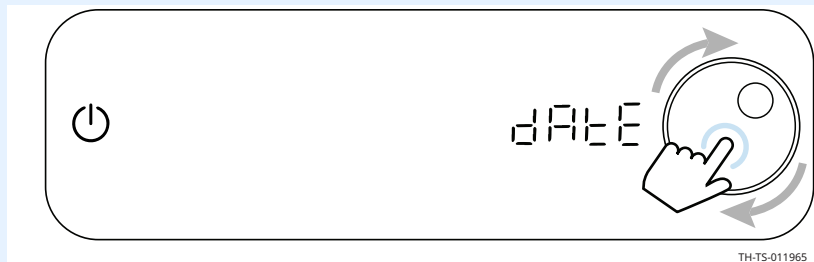

3. **Turn** the knob to select the year.
Press the knob to set the year.
Repeat the process to set the month and day.

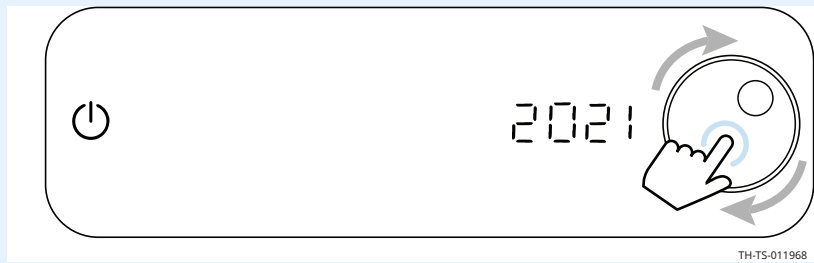

Continued on next page

Continued from previous page

4. **Turn** the knob to select the time.
Press the knob to set the time.



NOTE: Time is set in 24 hour format.

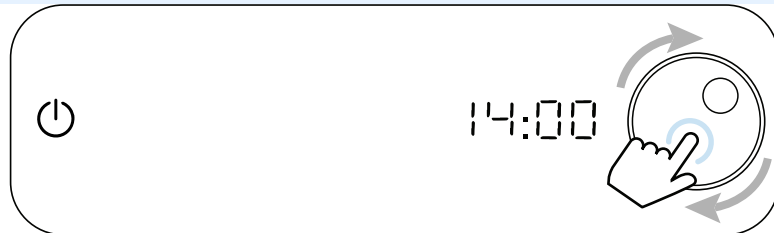

TH-TS-011971

The control will display “done” when the date and time has been set. The control will return to the main menu.

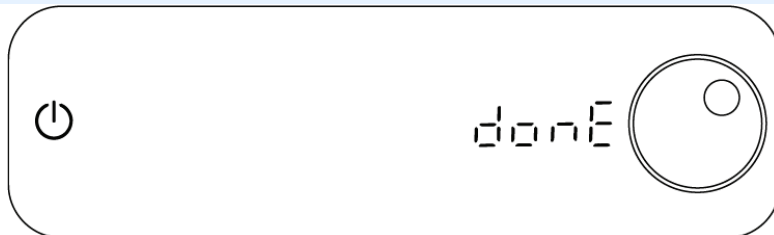

TH-TS-009806

Result

The date and time for HACCP data is now set.

How to Download HACCP Data (if equipped)

Before you begin

- You will need a USB drive.

Background

HACCP data provides automated record keeping, set-point validation, recipes used, dates and times. The data is stored until the information is downloaded. Once downloaded, the information is removed from the oven's memory. Best practice would be to download the information every 30 days to a USB drive. The file format is plain text file (.csv). The file can be viewed in Microsoft® Excel.

Procedure

To download HACCP data, do the following.

Step	Action
------	--------

- | | |
|----|--|
| 1. | Plug the USB drive into the port ①. |
|----|--|

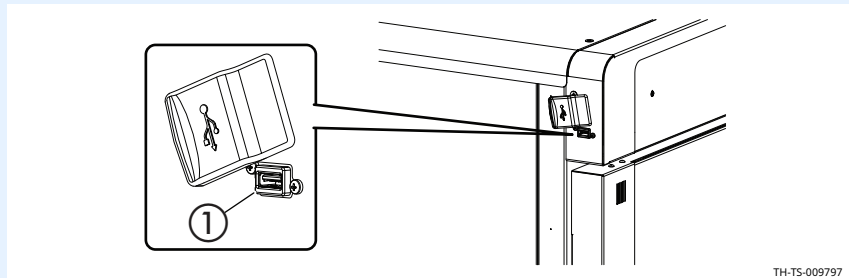

TH-TS-009797

- | | |
|----|---|
| 2. | Press and hold the knob to access the settings menu. |
|----|---|

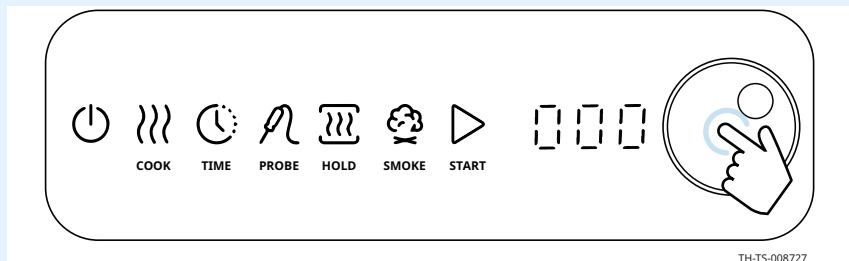

TH-TS-008727

Continued on next page

Continued from previous page

3. **Turn** the knob until the control displays USB.
Press the knob to access the USB menu.

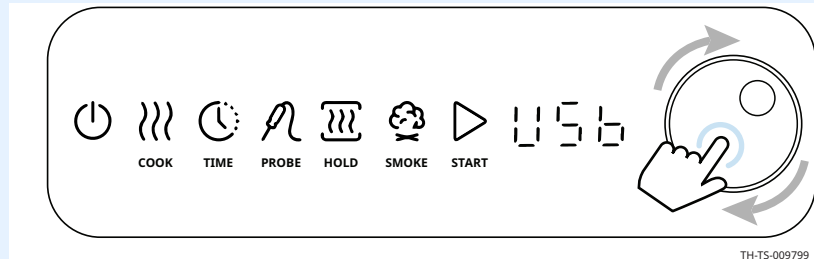

TH-TS-009799

4. **Turn** the knob until the control displays "HCCP".
Press the knob to select "HCCP" and begin the download.

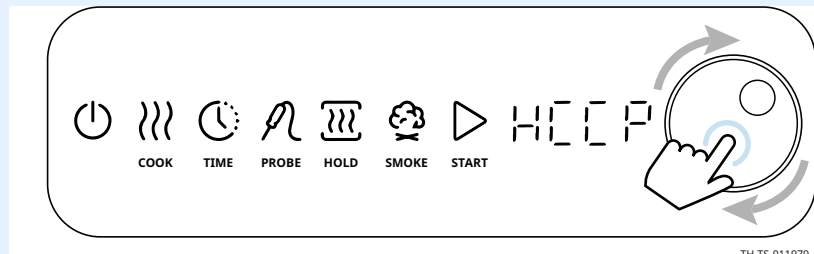

TH-TS-011979

When the HACCP download is complete, the control will flash "done". Press the knob to resume operation.

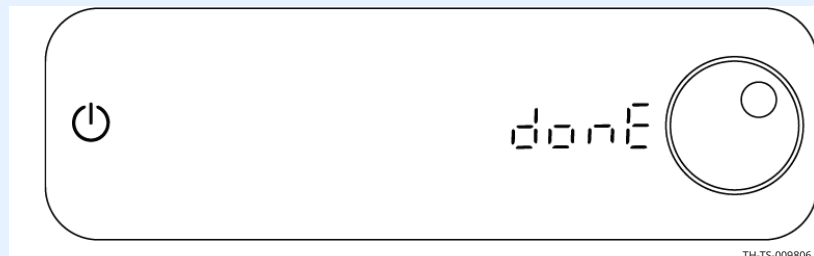

TH-TS-009806

5. **Remove** the USB drive.

Result

The HACCP data has been downloaded.

This page is intentionally left blank.

Maintenance Schedule

Requirements

- See topic *How to Clean the Oven*.
- Make sure the oven is cooled down and off—inside of chamber 140°F (60°C) or less.

Daily

For daily maintenance, do the following.

- See topic *How to Clean the Oven*, and follow the Daily Cleaning procedure.
- **Check** the screen for cracking or peeling. Contact Technical Service if needed.

Weekly

For weekly maintenance, do the following.

- See topic *How to Clean the Oven*, and follow the Weekly Cleaning procedure.
- **Check** the oven for any damage or loose parts.

Monthly

For monthly maintenance, do the following.

- **Inspect** door gasket.
- **Inspect** door window gasket for proper seal.
- **Inspect** cavity door vent slides for proper operation.
- **Inspect** side racks, shelves, and shelf supports for damage.
- **Calibrate** the removable product probe (if applicable)
- **Clean** the cooling fan intake area and exhaust vents.
- **Inspect** door handle screws and tighten if necessary.
- **Inspect** the smoke element (if applicable). If any deformation, cracks or breaks are seen, remove the oven from service and contact a factory authorized service technician.

Yearly

For yearly maintenance, do the following.



NOTE: Must be performed by a qualified professional.

- **Check and tighten** all wire connections.
- **Inspect** the smoke element and smoke element wiring.
- **Measure** the current draw of each cavity. Operate with smoker on if applicable.
- **Test** the heating elements for electrical short to ground.
- **Inspect** the condition of the cord and plug.

Continued on next page

Continued from previous page

- **Check and tighten** the cord connection inside of the appliance control area.
 - **Inspect** the control cooling fans (if applicable).
 - **Measure** the site voltage.
 - **Inspect and adjust** voltage monitor board if needed.
 - **Inspect** and test the product probe and product probe receptacle.
 - **Inspect** and test the control and control functions.
-
- **Inspect** the cavity for structural integrity.
 - **Inspect** the door gaskets for correct shape and seal. Replace/repair as needed.
 - **Inspect** the door handle and hinges. Replace/repair as needed.
 - **Inspect** the full perimeter bumper.
 - **Inspect** the casters.
 - **Do** a cavity temperature calibration procedure per manufacturer's recommendations.

How to Clean the Oven

Before you begin



WARNING: Electric shock hazard.

Set the power switch to the OFF position and unplug the oven before cleaning it.



CAUTION: Burn hazard.

Allow the oven, drip pans, and racks to cool before cleaning.



CAUTION: Corrosive materials hazard.

Wear eye protection and hand protection when cleaning.

NOTICE

Using improper cleaning procedures will damage the oven and void the warranty.

Only use spray cleaner when the electric power is completely removed from the oven.

Do not use steel pads, wire brushes, or scrapers when cleaning.

Daily cleaning procedure

To clean the oven daily, do the following.

Step	Action
1.	Make sure the oven is turned off and cool—cavity is less than 140°F (60°C).
2.	Remove all detachable items such as wire shelves, side racks, drip pan, and drip tray and clean these items separately.
3.	Remove any spills with disposable paper wipes or a damp cloth.
4.	Wipe the outside of the oven and the drip tray holder with a damp cloth.
5.	Wipe the control panel, door vents, door handles and door gaskets with a non-abrasive nylon scrub pad.
6.	If oven has an optional glass door, clean each side of the window pane with an all-purpose glass cleaner.
7.	Wipe probe, cable assembly, and probe prongs with a non-abrasive nylon scrub pad. Wipe probes with disposable alcohol pad or sanitizing solution recommended for food contact surfaces.
8.	Wipe the outside of the oven with a stainless steel cleaner.

Continued on next page

Continued from previous page

Weekly cleaning procedure

To clean the oven weekly, do the following.

Step	Action
1.	Set the power switch to the OFF position and unplug the appliance.
2.	Wipe the exterior areas of the oven with a non-abrasive nylon scrub pad.
3.	Spray the exterior areas of the oven with stainless steel polish. <div style="border: 1px solid blue; padding: 5px; margin-top: 10px;"> <p>NOTICE Use only non-caustic cleaners. Do not spray directly into the fan openings on the back of the oven. Do not use cleaners that contain sodium hydroxide (lye) or phosphorus.</p> </div>
4.	Spray the interior areas of the oven with oven cleaner. Let the cleaner work for 3–5 minutes.
5.	Wipe the interior of the oven with a non-abrasive nylon scrub pad.
6.	Clean the door gasket with a warm water and detergent solution.
7.	If oven has an optional glass door, clean each side of the window pane with an all-purpose glass cleaner.
8.	Plug the appliance in and set the power switch to the ON position when complete.

Result

The oven is now clean.

Error Codes

Code	Description	Cause	Remedy
ProG	Programmer error	Fatal error	Call Alto-Shaam technical support.
P111	Probe 1 open circuit, upper compartment	Open circuit detected on sensor wires.	1. Sensor connection 2. Sensor 3. Control Board
P110	Probe 1 short circuit, upper compartment	Short circuit detected on sensor wires.	1. Sensor connection 2. Sensor 3. Control Board
P711	Probe 1 open circuit, lower compartment	Open circuit detected on sensor wires	1. Sensor connection 2. Sensor 3. Control Board
P710	Probe 1 short circuit, lower compartment	Short circuit detected on sensor wires	1. Sensor connection 2. Sensor 3. Control Board
E-10	Cavity probe shorted	Short circuit detected on sensor wires. Halts any active program.	1. Sensor connection 2. Sensor 3. Control Board
E-11	Cavity probe open	Open circuit detected on sensor wires. Halts any active program.	1. Sensor connection 2. Sensor 3. Control Board
E-31	Unit over temperature	Cavity sensor over temperature too long. Halts active program if temperature exceeds 375°F / 190°C.	1. Cooling fan not operating 2. Installation clearance requirements not met
E-30	Unit under temperature	Cavity sensor under temperature too long.	Troubleshoot heating elements
E-79	Over-voltage	Supply voltage incorrect	Correct the supply voltage
E-78	Under-voltage	Supply voltage incorrect	Correct the supply voltage
E-109	High limit	Cavity high limit open. Stops any active program.	Any oven experiencing this error should be investigated by an authorized Alto-Shaam service provider.
E-b0	PCB shorted	PCB board temperature sensor is short-circuited.	Board failure
E-b1	PCB open	PCB board temperature sensor is open-circuit.	Board failure
E-b2	PCB over temperature	PCB board temperature sensor over 70° C.	1. Cooling Fan not operating 2. Installation clearance requirements not met
E-bC	Bootloader EEPROM RAM reset	Bootloader chip error	Requires power cycle to reset

TROUBLESHOOTING

EFA n	Check fans	Insufficient internal cooling airflow.	<ol style="list-style-type: none"> 1. Cooling fan filters dirty 2. Cooling fans not operating 3. Installation clearance requirements not met
UE01	USB error (USB not present)	USB not present	Insert USB, USB cable faulty
UE02	No such file on USB	Missing file on USB	Load the correct file onto the USB
U-05	HACCP date/time not set, no communication with RTC chip	Cable not connected or damaged	<ol style="list-style-type: none"> 1. Set the date and time 2. Check and reset or replace cable
U-06	No communication with the HACCP module	Cable not connected or damaged	<ol style="list-style-type: none"> 1. Check and reset or replace cable 2. Replace HACCP board
U-07	No communication with flash chip on HACCP module	Cable not connected or damaged	<ol style="list-style-type: none"> 1. Check and reset or replace cable 2. Replace HACCP board

What to do if a Power Interruption Occurs

Background

You may need to reset the oven if a power interruption occurs.

Procedure

To continue operation of the oven, do the following.

Step	Action
------	--------

1. For TH-300 ovens, set the power switch to the ON position.

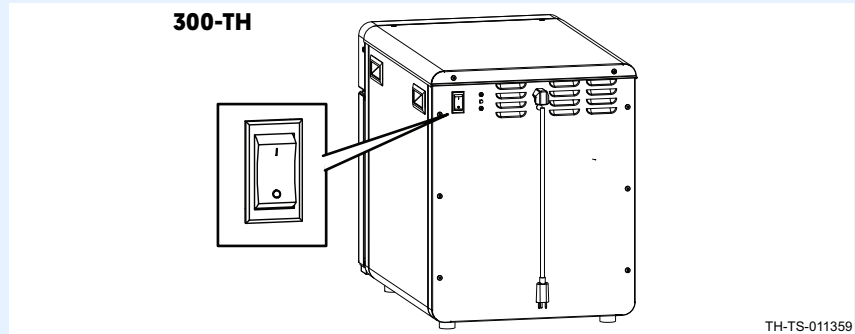

The interface board (IB) software version displays.

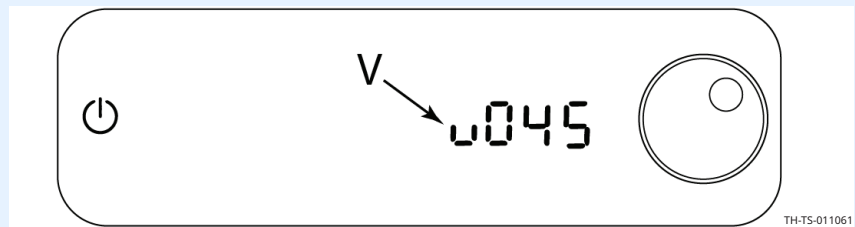

The control board (CB) software version displays.

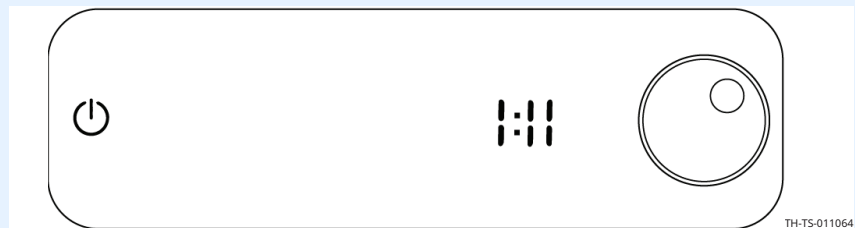

Power failure (PF) displays.

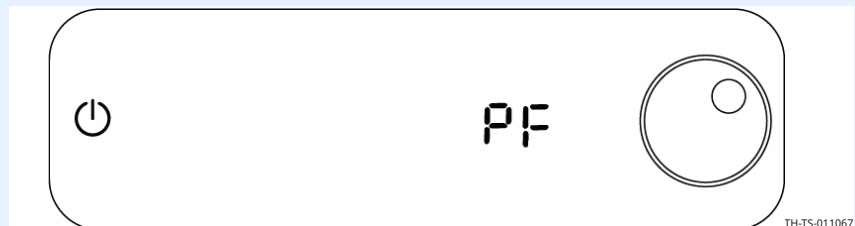

Continued on next page

Continued from previous page

2. **Touch** the power icon to clear the power failure (PF).

NOTE: For ovens equipped with a HACCP module, the control will display "PF", then the duration of the power failure.

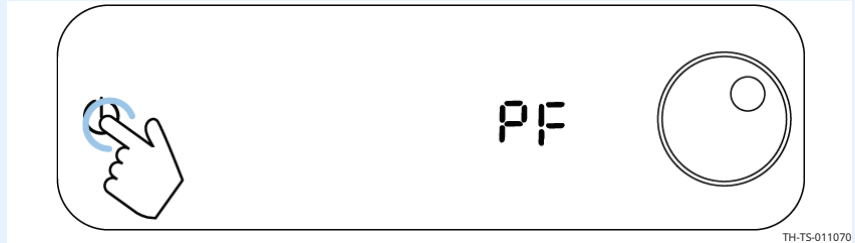

The display will go blank. **Touch** the power icon.

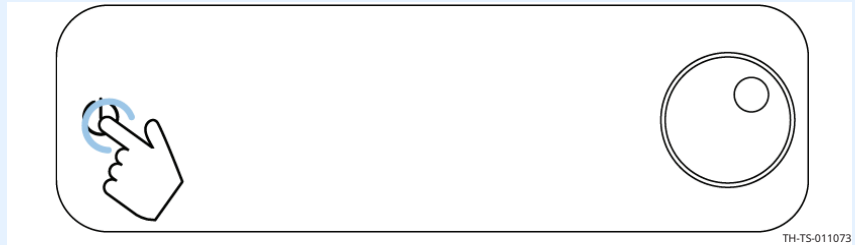

The display will power up and the icons display.

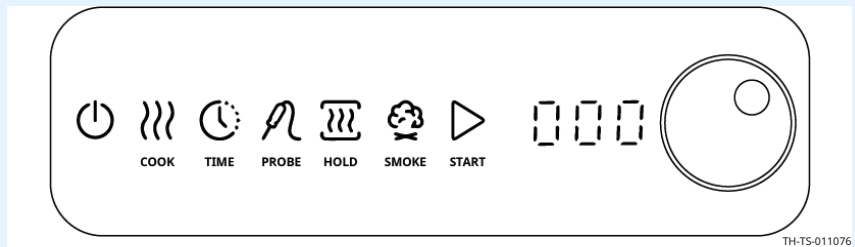

Result

Resume operation of the oven.

Warranty

Introduction

Alto-Shaam, Inc. warrants to the original purchaser only, that any original part found to be defective in material or workmanship will be replaced with a new or rebuilt part at Alto-Shaam's option, subject to provisions hereinafter stated.

Warranty Period

The original parts warranty period is as follows:

- For all other original parts, one (1) year from the date of installation of appliance or fifteen (15) months from the shipping date, whichever occurs first.
- The labor warranty period is one (1) year from the date of installation or fifteen (15) months from the shipping date, whichever occurs first.
- Alto-Shaam will bear normal labor charges performed during standard business hours, excluding overtime, holiday rates or any additional fees.
- For the refrigeration compressor, if installed, the warranty period is five (5) years from the date of original installation of the appliance.
- For heating elements on Halo Heat® Cook and Hold ovens, the warranty period is for as long as the original owner owns the oven. This warranty period applies to units sold after 2/1/2009 and excludes holding-only ovens.
- To be valid, a warranty claim must be asserted during the applicable warranty period. This warranty is not transferable.

Exclusions

This warranty does not apply to:

- Calibration.
- Replacement of light bulbs, rubber gaskets, grease filters, air filters, racks, jet plates, and/or the replacement of glass due to damage of any kind.
- Equipment damage caused by accident, shipping, improper installation or alteration.
- Equipment used under conditions of abuse, misuse, carelessness or abnormal conditions, including but not limited to, equipment subjected to harsh or inappropriate chemicals, including but not limited to, compounds containing chloride or quaternary salts, poor water quality, or equipment with missing or altered serial numbers.
- Equipment damage caused by use of any cleaning agents other than those recommended by Alto-Shaam, including but not limited to damage due to chlorine or other harmful chemicals.
- Any losses or damage resulting from malfunction, including loss of food product, revenue, or consequential or incidental damages of any kind.
- Equipment modified in any manner from original model, substitution of parts other than factory authorized parts, unauthorized removal of any parts including legs, or unauthorized addition of any parts.

Continued on next page

Continued from previous page

- Equipment damage incurred as a direct result of poor water quality*, inadequate maintenance of steam generators and/or surfaces affected by water. Water quality and required maintenance of steam generating equipment is the responsibility of the owner/operator.
 - Equipment damage incurred as a result of not following the required maintenance schedule published in the manuals for the equipment.
-

Conclusion

This warranty is exclusive and is in lieu of all other warranties, express or implied, including the implied warranties of merchantability and fitness for a particular purpose. No person except an officer of Alto-Shaam, Inc. is authorized to modify this warranty or to incur on behalf of Alto-Shaam any other obligation or liability in connection with Alto-Shaam equipment.

**Refer to the product spec sheet for water quality standards.*

DECLARATION OF CONFORMITY

Manufacturer:
Alto-Shaam, Inc.
W164 N9221 Water Street
Menomonee Falls, WI 53202-0450



EQUIPMENT TYPE: Household and Similar Electric Appliances

EQUIPMENT DESCRIPTION: Commercial Cooking, Holding and Smoking Ovens

MODEL NUMBER: 300, 500, 750, 1000, 1200, 1750,
with suffix TH or SK

APPLIED DIRECTIVES: Low Voltage Directive 2014/35/EC
EMC – 2014/30/EC
RoHS – 2011/65/EU
WEEE – 2012/19/EU

APPLIED STANDARDS: EN 60335-1:2014
EN 60335-2-42:2003 + A1:2008 + A11:2012
EN 55014-1: CISPR 14, EN 55014-2: CISPR 14



We the undersigned, hereby declare that the equipment specified above conforms to the above Directives and Standards

Manufacturer Name:
ALTO-SHAAM INC.
NAME: Christa Pieper
TITLE: Certification Manager

SIGNATURE: 

DATE: October 9th 2020

DECLARATION OF CONFORMITY



ALTO-SHAAM.

Menomonee Falls, WI U.S.A.

Phone 800-558-8744 | +1-26 2-251-3800 | alto-shaam.com

ASIA

Shanghai, China
Phone +86-21-6173-0336

AUSTRALIA

Brisbane, Queensland
Phone 800-558-8744

CANADA

Concord, Ontario Canada
Toll Free Phone 866-577-4484
Phone +1-905-660-6781

FRANCE

Aix en Provence, France
Phone +33(0)4-88-78-21-73

GMBH

Bochum, Germany
Phone +49 (0)234 298798-0

ITALY

Padua, Italy
Phone +39 3476073504

INDIA

Pune, India
Phone +91 9657516999

MEXICO

Phone +52 1 477-717-3108

MIDDLE EAST & AFRICA

Dubai, UAE
Phone +971-4-321-9712

CENTRAL & SOUTH AMERICA

Miami, FL USA
Phone +1 954-655-5727

RUSSIA

Moscow, Russia
Phone +7 903 7932331