

get started

INSTANT POT® DUO™ PLUS
MULTI-COOKER

Instant

Table of contents

Welcome!	4
Register your product.....	4
Contact us.....	4
Product specifications.....	4
How to find the model name and serial number.....	4
IMPORTANT SAFEGUARDS	5
Special cord set instructions.....	9
Product, parts and accessories	10
Get started	12
Initial set up.....	12
Initial test run (water test).....	13
Pressure cooking 101	14
Releasing pressure	15
Control panel.....	17
Settings.....	18
Status messages.....	20
Pressure control features	21
Multi-cooker lid.....	21
Quick release switch.....	22
Sealing ring.....	23
Anti-block shield.....	23
Float valve.....	24
Pressure cooking Smart Programmes	25
Using pressure cooking Smart Programmes.....	26
Smart Programme details.....	27
Pressure cooking grains.....	28

Other cooking Smart Programmes	29
Slow Cook	30
Sauté	31
Yogurt	32
Sous Vide	34
Care, cleaning and storage	37
Removing and installing parts.....	38
Silicone sealing ring	38
Steam release valve	39
Anti-block shield.....	39
Float valve and silicone cap.....	40
Condensation collector.....	40
Troubleshooting	41
Warranty	44

Welcome!

Thank you for purchasing your new Instant Pot® Duo™ Plus multi-cooker. We hope you enjoy cooking with it for years to come.

Register your product

Register your Instant Pot Duo Plus today at instantpot.com.au/support/register.

Contact us







When you have questions about your new Instant Pot, we're here to help.

Phone: 1800 251 643 or (02) 9317 1000

Email: support@instantpot.com.au

Web: instantpot.com.au

Product specifications

					
Duo Plus 30 v2	580-700W	220-240V~ 50-60Hz	3 Litres	3.9 kg	cm: 27 L x 29.6 W x 28.4 H
Duo Plus 60 v2	840-1000W	220-240V~ 50-60Hz	5.7 Litres	5.2 kg	cm: 31 L x 34 W x 33 H
Duo Plus 80 v2	1000-1200W	220-240V~ 50-60Hz	8 Litres	6.8 kg	cm: 33.5 L x 38 W x 36.5 H

Find your model name and serial number

Model Name: Find it on the rating label on the back of the multi-cooker base, near the power cord.

Serial Number: Turn the multi-cooker base over - you'll find this information on a sticker on the bottom.

IMPORTANT SAFEGUARDS



At Instant Brands™ your safety always comes first. The Instant Pot® Duo™ Plus was designed with your safety in mind.

As always, be careful when using electrical appliances and follow basic safety precautions.

- 01** READ ALL INSTRUCTIONS, SAFEGUARDS AND WARNINGS BEFORE USE. FAILURE TO FOLLOW THESE SAFEGUARDS AND INSTRUCTIONS MAY RESULT IN INJURY AND/OR PROPERTY DAMAGE.
- 02** Use only the Instant Pot Duo Plus lid with the Instant Pot Duo Plus multi-cooker base. Using any other multi-cooker lids may cause injury and/or damage.
- 03** For household use only. Not for commercial use. DO NOT use the appliance for anything other than its intended use.
- 04** For countertop use only. Always operate the appliance on a stable, non-combustible, level surface.
 - DO NOT place on anything that may block the vents on the bottom of the appliance.
 - DO NOT place on a hot stove.
- 05** Heat from an external source will damage the appliance.
 - DO NOT place the appliance on or close to a hot gas or electric burner, or a heated oven.
 - DO NOT use the appliance near water or flame.
 - DO NOT use outdoors. Keep out of direct sunlight.
- 06** DO NOT touch the appliance's hot surfaces. Only use the side handles for carrying or moving.
 - DO NOT move the appliance when it is under pressure.
 - DO NOT touch accessories during or immediately after cooking.
 - DO NOT touch the metal portion of the lid when the appliance is in operation; this could result in injury.
 - Always use hand protection when removing accessories, and to handle the inner pot.
 - Always place hot accessories on a heat-resistant surface or cooking plate.

WARNING

Read this manual carefully and completely and retain for future reference. Failure to adhere to safety instructions may result in serious injury or damage.

IMPORTANT SAFEGUARDS



- 07 The removable inner pot can be extremely heavy when full of ingredients. Care should be taken when lifting the inner pot from the multi-cooker base to avoid burn injury.
- Extreme caution must be used when the inner pot contains hot food, hot oil or other hot liquids.
 - DO NOT move the appliance while it is in use and use extreme caution when disposing of hot grease.
- 08 **⚠ CAUTION** Overfilling may cause a risk of clogging the steam release pipe and developing pressure, which may result in burns, injury, and/or property damage.
- DO NOT fill over **PC MAX** — $\frac{2}{3}$ as indicated on the inner pot.
 - DO NOT fill the inner pot over — $\frac{1}{2}$ line when cooking foods that expand during cooking such as rice or dried vegetables.
- 09 **⚠ WARNING** This appliance cooks under pressure. Any pressure in the appliance can be hazardous. Allow the appliance to depressurise naturally or release all excess pressure before opening. Inappropriate use may result in burns, injury and/or property damage.
- Make sure the appliance is properly closed before operating. Refer to **Pressure control features: multi-cooker lid**.
 - DO NOT cover or obstruct the steam release valve and/or float valve with cloth or other objects.
 - DO NOT attempt to open the appliance until it has depressurised, and all internal pressure has been released. Attempting to open the appliance while it is still pressurised may lead to sudden release of hot contents and may cause burns or other injuries.
 - DO NOT place your face, hands or exposed skin over the steam release valve or float valve when the appliance is in operation or has residual pressure, and do not lean over the appliance when removing the lid.
 - Turn the appliance off if steam escapes from the steam release valve and/or float valve in a steady stream for longer than 3 minutes.
 - If steam escapes from the sides of the lid, turn the appliance off and make sure the sealing ring is properly installed. Refer to **Pressure control features: sealing ring**.
 - DO NOT attempt to force the lid off the Instant Pot multi-cooker base. Refer to **Releasing pressure**.

⚠ WARNING

Read this manual carefully and completely and retain for future reference.
Failure to adhere to safety instructions may result in serious injury or damage.

IMPORTANT SAFEGUARDS



- 10 When cooking meat with skin (e.g. sausage with casing), the skin can swell when heated. Do not pierce the skin while it is swollen; this could result in scalding injury.
- 11 When pressure cooking food with a doughy or thick texture, or a high fat/oil content, contents may splatter when opening the lid. Follow recipe instructions for pressure release method. Refer to **Releasing pressure**.
- 12 Oversized foods and/or metal utensils must not be inserted into the inner pot as they may cause risk of fire and/or personal injury.
- 13 Proper maintenance is recommended before and after each use:
 - Check the steam release valve, steam release pipe, anti-block shield and float valve for clogging;
 - Before inserting the inner pot into the multi-cooker base, make sure both parts are dry and free of food debris;
 - Let the appliance cool to room temperature before cleaning or storage.
- 14 DO NOT use this appliance for deep frying or pressure frying with oil.
- 15 If the power cord is detachable, always attach the plug to the appliance first, then plug the cord into the wall outlet. To turn off, press **Cancel**, then remove the plug from power source. Always unplug when not in use, as well as before adding or removing parts or accessories, and before cleaning. To unplug, grasp the plug and pull from the outlet. Never pull from the power cord.
- 16 Regularly inspect the appliance and power cord. Do not operate the appliance if the power cord or plug is damaged, or after the appliance malfunctions or is dropped or damaged in any manner. For assistance, contact Customer Care by email at support@instantpot.com.au or by phone at 1800 251 643 or (02) 9317 1000.
- 17 Spilled food can cause serious burns. A short power-supply cord is provided to reduce the hazards resulting from grabbing, entanglement and tripping.
 - DO NOT let the power cord hang over edges of tables or counters, or touch hot surfaces or open flame, including the stovetop.
 - DO NOT use below-counter power outlets, and never use with an extension cord.
 - Keep the appliance and cord away from children.

WARNING

Read this manual carefully and completely and retain for future reference.
Failure to adhere to safety instructions may result in serious injury or damage.

IMPORTANT SAFEGUARDS



- 18 DO NOT use any accessories or attachments not authorised by Instant Brands LLC. The use of parts, accessories or attachments not recommended by the manufacturer may cause a risk of injury, fire or electric shock.
 - To reduce the risk of pressure leakage, cook only in an authorised stainless-steel Instant Pot inner pot.
 - DO NOT use the appliance without the removable inner pot installed.
 - To prevent personal injury and damage to the appliance, only replace the sealing ring with an authorised Instant Pot sealing ring.
- 19 DO NOT attempt to repair, replace or modify components of the appliance, as this may cause electric shock, fire or injury, and will void the warranty.
- 20 DO NOT tamper with any of the safety mechanisms, as this may result in injury or property damage.
- 21 The multi-cooker base contains electrical components. To avoid electrical shock:
 - DO NOT put liquid of any kind into multi-cooker base.
 - DO NOT immerse power cord, plug or the appliance in water or other liquid.
 - DO NOT rinse the appliance under tap.
- 22 DO NOT use the appliance in electrical systems other than 220-240V~50-60Hz. Do not use with power converters or adapters.
- 23 This appliance is NOT to be used by children or by persons with reduced physical, sensory or mental capabilities. Close supervision is necessary when any appliance is used near children and these individuals. Children should not play with this appliance.
- 24 DO NOT leave the appliance unattended while in use. Never connect this appliance to an external timer switch or separate remote-control system.
- 25 DO NOT store any materials in the multi-cooker base or inner pot when not in use.
- 26 DO NOT place any combustible materials in the multi-cooker base or inner pot, such as paper, cardboard, plastic, Styrofoam or wood.

WARNING

Read this manual carefully and completely and retain for future reference.
Failure to adhere to safety instructions may result in serious injury or damage.

IMPORTANT SAFEGUARDS



- 27 DO NOT use the included accessories in a microwave, toaster oven, convection or conventional oven, or on a ceramic cooktop, electric coil, gas range or outdoor grill.

SAVE THESE INSTRUCTIONS.

⚠ WARNING

To avoid injury, read and understand the instructions in this user manual before attempting to use this appliance.

⚠ WARNING

Electrical shock hazard. Use grounded outlet only.

- DO NOT remove ground.
- DO NOT use an adapter.
- DO NOT use an extension cord.

Failure to follow these instructions may result in electric shock and/or serious injury.

⚠ WARNING

THE FAILURE TO FOLLOW ANY OF THE IMPORTANT SAFEGUARDS AND/OR THE INSTRUCTIONS FOR SAFE USE IS A MISUSE OF YOUR APPLIANCE THAT CAN VOID YOUR WARRANTY AND CREATE THE RISK OF SERIOUS INJURY.

Special cord set instructions

Per safety requirement, a short power supply cord is provided to reduce the hazards resulting from entanglement and tripping.

This appliance has a 3-prong grounding plug. To reduce the risk of electric shock, plug the power cord into a grounded electrical outlet that is easily accessible.

⚠ WARNING

Read this manual carefully and completely and retain for future reference. Failure to adhere to safety instructions may result in serious injury or damage.

Product, parts and accessories

See **Care, cleaning and storage: Removing and installing parts** to find out how everything fits together.

Top of lid

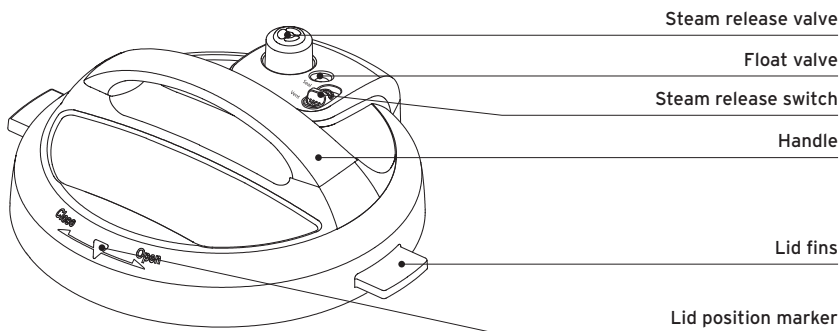

Bottom of lid

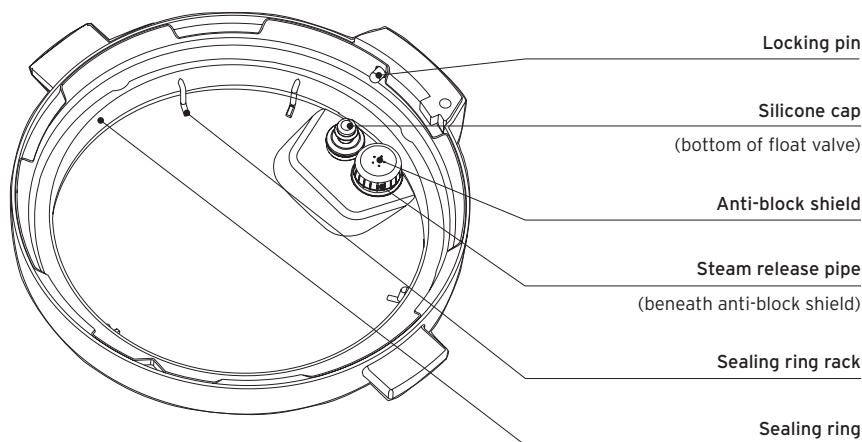

 **Instant Tip:** Stand the lid up in the base handles to keep it off your countertop! Insert the left or right lid fin into corresponding slot in the multi-cooker base handles to stand it up and save some space.

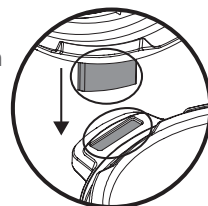

Illustrations in this document are for reference only and may differ from the actual product. Always refer to the actual product.

Product, parts and accessories

Inner pot

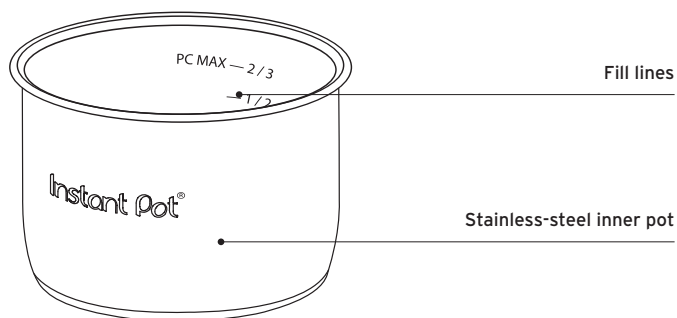

Multi-cooker base

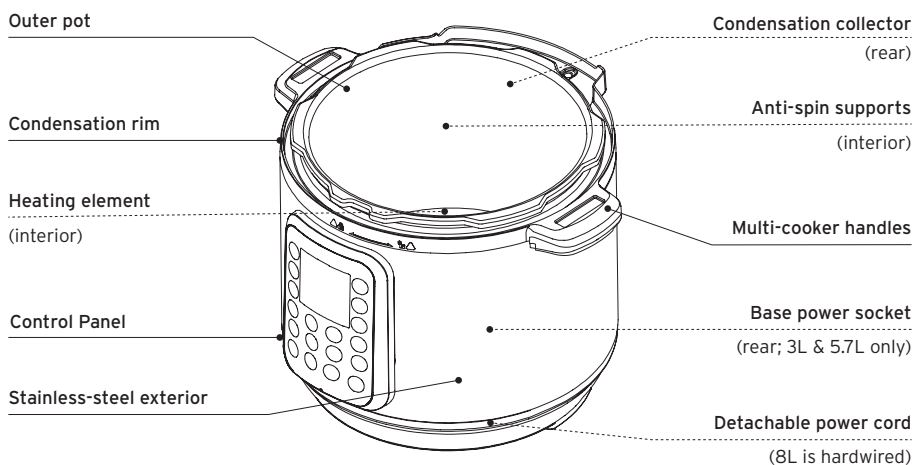

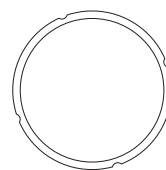
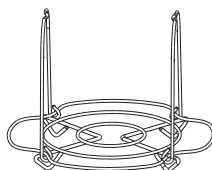

Accessories



Illustrations in this document are for reference only and may differ from the actual product. Always refer to the actual product.

Get started

Initial set up

- 01** Pull that Duo Plus out of the box!
- 02** Remove the packaging material and accessories from in and around the multi-cooker.
 -  Make sure to check under the inner pot!
- 03** Wash the inner pot in a dishwasher or with hot water and dish soap. Rinse it well with warm, clear water and use a soft cloth to thoroughly dry the outside of the inner pot.
- 04** Wipe the heating element with a soft, dry cloth to make sure there are no stray packaging particles left in the multi-cooker base.
 -  Don't remove the safety warning stickers from the lid or the rating label from the back of the multi-cooker base.
- 05** You may be tempted to put the Instant Pot on your stovetop – *but don't do it!* Place the multi-cooker base on a stable, level surface, *away* from combustible material and external heat sources.

Is something missing or damaged?

Get in touch with Customer Care by email at support@instantpot.com.au or by phone at 1800 251 643 or (02) 9317 1000.

WARNING

Read the **Important safeguards** before using the appliance. Failure to read and follow those instructions for safe use may result in damage to the appliance, personal injury and/or property damage.

Do not place the appliance on a stovetop or upon another appliance. Heat from an external source will damage the appliance.

Do not place anything on top of the appliance, and do not cover or block the steam release valve or anti-block shield, located on the appliance lid to avoid risk of injury and/or property damage.

Get started

Initial test run (water test)

Do you *have* to do the water test? No – but getting to know the ins and outs of your Duo Plus prepares you for success in the kitchen!

Stage 1: Setting up the Duo Plus for pressure cooking

01 Remove the inner pot from the multi-cooker base. Add 750 mL of water to the inner pot, then insert it back into the multi-cooker base.

02 3L & 5.7L only: Secure the power cord to the base power socket on the back of the multi-cooker base. Make sure the connection is tight.

All sizes: Connect the power cord to a 220-240V power source.

The display shows **OFF**.

03 Place and close the lid as described in **Pressure control features: Multi-cooker lid**.

Stage 2: "Cooking" (...but not really, this is just a test!)

01 Select **Pressure Cook**.

02 Use the **- / + Time** buttons to adjust the cooking time to 5 minutes (**00:05**).

 Adjustments are saved when a Smart Programme starts, so the next time you use Pressure Cook, it will default to 5 minutes.

03 Press **Keep Warm** to turn the automatic Keep Warm setting off.

04 Press **Start** to begin. The display shows **On**.

 While the multi-cooker does its thing, read **Pressure cooking 101** on the next page to find out how the magic happens.

05 When the Smart Programme finishes, the display shows **End**.

Stage 3: Releasing pressure

01 Follow instructions for a Quick Release in **Releasing pressure: Venting methods**.

02 Wait for the float valve to drop, then carefully open and remove the lid as described in **Pressure control features: Multi-cooker lid**.

03 Using proper hand protection, remove the inner pot from the multi-cooker base, discard the water and thoroughly dry the inner pot.

CAUTION

Pressurised steam releases through the top of the steam release valve. Keep exposed skin away from the steam release valve to avoid injury.

DANGER

DO NOT attempt to remove the lid while the float valve is up and NEVER attempt to force the lid open. Contents are under extreme pressure. Float valve must be down before attempting to remove the lid. Failure to follow these instructions may result in serious personal injury and/or property damage.

CAUTION

The inner pot will be hot after cooking. Always use appropriate heat protection when handling a hot inner pot to avoid injury.

Pressure cooking 101

Pressure cooking uses steam to raise the boiling point of water above 100°C. These high temperatures allow you to cook some foods way faster than normal.

How it works

When pressure cooking, the Instant Pot goes through 3 stages.

Pre-heating

What you see	What you don't see	Tips
The display shows On .	While the multi-cooker pre-heats, it vaporises liquid to create steam. Once enough steam has built up, the float valve pops up and locks the lid in place.	The time it takes the multi-cooker to pressurise depends on things like food and liquid temperature and volume. Frozen foods have the longest pre-heating time. For the fastest results, thaw your food before cooking it. While you're waiting, read over Releasing pressure for information on safe venting techniques.

Cooking

What you see	What you don't see	Tips
The float valve may release a bit of steam before it pops up and seals the multi-cooker. The display switches to the cooking countdown timer.	When the multi-cooker reaches the required pressure level, cooking begins. The Instant Pot automatically maintains High or Low pressure throughout cooking.	A higher pressure means a higher temperature. Smart Programme settings (such as, cooking time, pressure level, etc.) can be adjusted at any time during cooking.

Releasing pressure

What you see	What you don't see	Tips
If Keep Warm is on after cooking, the timer counts up from 00:00 . If not, the multi-cooker goes back to standby and the display shows End . The float valve is still popped up.	Although food has finished cooking, the multi-cooker is still pressurised and hot, which is why the float valve is up. Releasing pressure lowers the temperature inside the multi-cooker, which allows you to safely remove the lid once the float valve drops.	See Releasing pressure for information on safe venting techniques and what they're used for. Follow your recipe instructions to choose the best venting method for your meal.  Instant Tip: The Instant Pot cools faster if Keep Warm is turned off.

Releasing pressure

You **must** release pressure after pressure cooking before attempting to open the lid. Follow your recipe's instructions to choose a venting method, and always wait until the float valve drops into the lid before opening.

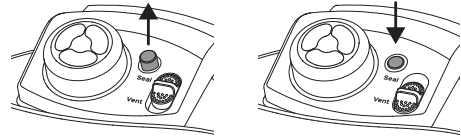

Pressurised

Depressurised

⚠ WARNING

Steam ejected from the steam release valve is hot. **DO NOT** place hands, face, or any exposed skin over the steam release valve when releasing pressure to avoid risk of injury.

DO NOT cover the steam release valve to avoid risk of injury and/or property damage.

⚠ DANGER



DO NOT attempt to remove the lid while the float valve is up and NEVER attempt to force the lid open. Contents are under extreme pressure. Float valve must be down before attempting to remove the lid. Failure to follow these instructions may result in serious personal injury and/or property damage.

Venting methods

- Natural Release (NR or NPR)
- Quick Release (QR or QPR)
- Timed Natural Release

Natural Release (NR or NPR)

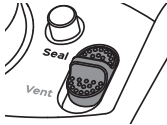
Cooking stops gradually. As the temperature within the multi-cooker drops, the Instant Pot depressurises naturally over time.

What to do	What to expect
<p>After cooking finishes, leave the quick release switch in the Seal position until the float valve drops into the lid.</p>  <p>Seal position</p>	<p>Your meal continues to cook even after the Smart Programme ends.</p> <p> Instant Tip: This is called “carryover cooking” or “resting”, and it’s great for large cuts of meat.</p> <p>The depressurisation time may vary based upon the volume, type and temperature of food and liquid. It can take up to 40 minutes with some dishes, so plan ahead – it’s well worth the wait!</p> <p>When pressure has been fully released, the float valve drops into the lid.</p>

NOTICE

Use NR to depressurise the multi-cooker after cooking high-starch foods (e.g., soups, stews, chilis, pasta, oatmeal and congee) or after cooking foods that expand when cooked (e.g., beans and grains).

Releasing pressure

Quick Release (QR or QPR)

Stops cooking quickly and prevents overcooking. Perfect for quick-cooking vegetables and delicate seafood!

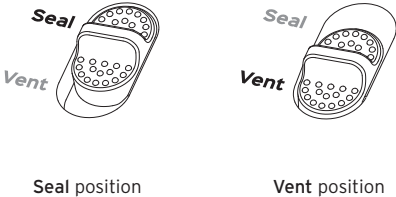
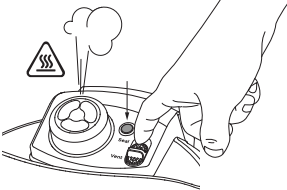
What to do	What to expect
<p>Move the quick release switch from Seal to Vent and wait until the float valve drops into the lid.</p>  <p>The diagram shows two views of the quick release switch. On the left, the switch is in the 'Seal' position, with the top of the lid closed. On the right, the switch is in the 'Vent' position, with the top of the lid open. Labels 'Seal' and 'Vent' are placed above each respective diagram. Below the diagrams are the labels 'Seal position' and 'Vent position'.</p>	<p>A jet of steam ejects through the top of the steam release valve.</p> <p>This is normal!</p> <p>When pressure has been fully released, the float valve drops into the lid.</p>  <p>The illustration shows a hand turning the quick release switch on a multi-cooker. A jet of steam is being ejected from the top of the lid. A warning symbol (SSS) is shown next to the steam release valve.</p>

If you see a lot of spatter while releasing pressure, move the quick release switch back from **Vent** to **Seal**, and wait a few minutes before trying to release pressure again. If spatter continues, use NR to safely release the remaining pressure.

Timed natural release

The carryover cooking continues for a specific amount of time, then stops quickly when you release the remaining pressure. Perfect for finishing rice and grains.

What to do	What to expect
<p>Leave the quick release switch in the Seal position for a few minutes (according to your recipe) then move it from Seal to Vent and wait until the float valve drops into the lid.</p>	<p>A jet of steam ejects through the top of the steam release valve.</p> <p> The temperature within the multi-cooker drops, so the steam release may not be as powerful as a normal QR.</p> <p>When pressure has been fully released, the float valve drops into the lid.</p>

⚠ CAUTION

Steam ejected from the steam release valve is hot. **DO NOT** place hands, face, or any exposed skin over the steam release valve when releasing pressure to avoid injury.

NOTICE

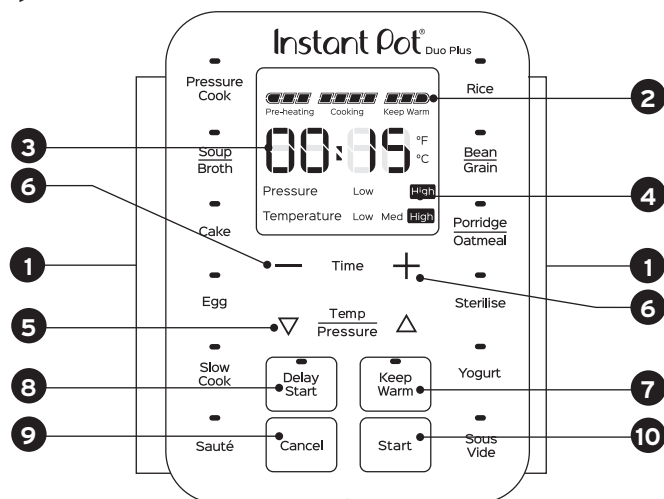

Do not use QR when cooking fatty, oily, thick or high-starch foods (e.g., stews, chilis, pasta and congee) or when cooking foods that expand when cooked (e.g., beans and grains).

Control panel





1	Smart Programmes	Pressure cooking <ul style="list-style-type: none"> • Pressure Cook • Soup/Broth • Cake • Egg • Rice • Bean/Grain • Porridge/Oatmeal • Sterilise 	Non-pressure cooking <ul style="list-style-type: none"> • Slow Cook • Sauté • Yogurt • Sous Vide
2	Cooking progress bar	Shows the cooking progress in different Smart Programmes and modes.	
3	Time display	Shows the time in HH:MM format. Counts up or down, depending on the Smart Programme. ✎ Also displays temperature in °C (Celsius) or °F (Fahrenheit) during Sous Vide.	
4	Pressure	Shows Low or High pressure during pressure cooking.	
	Temperature	Shows when the multi-cooker is using Low, Med or High temperature.	
5	Temp / Pressure buttons	Toggles between temperature and pressure levels.	
6	- / + Time buttons	Adjusts time for cooking, Delay Start and Keep Warm.	
7	Keep Warm	Turns the Keep Warm setting on or off.	
8	Delay Start	Delays the start of cooking.	
9	Cancel	Stops a Smart Programme at any time.	
10	Start	Begins the selected Smart Programme.	

Settings

Setting	Description
Turn sound on.	When in standby (OFF), press and hold the + button until the display shows S On .
Turn sound off.	When in standby (OFF), press and hold the - button until the display shows SOFF .  Audible safety and error message alerts cannot be turned off.
Adjust and save custom cooking times and temperatures.	Once a Smart Programme is selected, changes to the cooking time, temperature and pressure level are saved once the Smart Programme begins. See Cooking for details.
Reheat or warm for long periods.	Keep Warm can be used for up to a maximum of 10 hours (10:00). 01 When in standby, press Keep Warm . 02 Use the Temp/Pressure buttons to cycle through Low, Med and High warming temperature levels. 03 Use the - / + Time buttons to set a warming timer. 04 Press Start to begin.  When cooking thick or starchy foods, heat may not dissipate evenly. To ensure food safety, stir the contents of thicker dishes every 40 to 60 minutes. When Keep Warm completes, the display shows End .
Set a kitchen timer.	Delay Start can be used as a kitchen timer to help manage mealtime. 01 When in standby, press Delay Start . 02 When the time field flashes, use the - / + Time buttons to adjust the timer as needed. 03 Press Start to begin. When the countdown ends, the multi-cooker beeps and shows End .

Settings

Setting	Description
<p>Set a Delay Start timer.</p>	<p>Delay Start can be set from between 10 minutes (00:10) and 24 hours (24:00).</p> <p>01 Select a Smart Programme and tweak it as needed, then press Delay Start.</p> <p> Once pressed, there is no way to go back to the Smart Programme settings. You'll have to press Cancel and start again.</p> <p>02 When the time field flashes, use the - / + Time buttons to adjust the delay start time.</p> <p>03 Press Start to begin.</p> <p>When Delay Start ends, the Smart Programme begins and the display shows On.</p> <p> Delay Start is not available with the Sauté, Sous Vide or Yogurt Smart Programmes.</p>
<p>Reset an individual Smart Programme.</p>	<p>When in standby, press and hold one Smart Programme button until the multi-cooker returns to Standby and displays OFF.</p> <p>The Smart Programme's pressure level, cooking time and temperature are restored to the factory default setting.</p>
<p>Reset all Smart Programmes.</p>	<p>When in standby, press and hold Cancel until the multi-cooker beeps.</p> <p>All Smart Programme pressure levels, cooking times and temperatures are restored to the factory default setting.</p>

Status messages

OFF	The Instant Pot is in standby mode, ready for action!
Lid	May indicate that the lid is missing or is not properly secured.
On	The multi-cooker is Pre-heating .
boil	The Yogurt Smart Programme is in the process of pasteurising milk (i.e., the Yogurt Smart Programme is set to More).
Hot	The Sauté or Sous Vide Smart Programme has reached the ideal cooking temperature and food may be added to the inner pot.
00:00	<p>Display shows one of the following:</p> <ul style="list-style-type: none"> • When a Smart Programme is running, the timer counts down the remaining cooking time; • When Delay Start is running, the timer counts down until the Smart Programme begins; • When Keep Warm is running, the timer counts the length of time that food has been warming.
End	The Smart Programme has finished and Keep Warm is off.
Food burn	The multi-cooker may be overheating due to insufficient liquid. See Troubleshooting for more information.

Do you see something else? See **Troubleshooting** for more information.

Pressure control features

See **Care, cleaning and storage** for installation and removal of parts.

Multi-cooker lid

What we love about it	What you should know about it
<p>When you close it, it sets to Seal automatically, for seriously easy pressure cooking.</p> <p>While plugged in, the Duo Plus plays a little jingle when you open and close the lid.</p>	<p>The lid is removable during non-pressure cooking so you can taste-test as you go.</p> <p>When you're pressure cooking, the lid only locks into place once the multi-cooker has pressurised. Try not to remove the lid unnecessarily!</p>

Removing the lid

- 01** Grip the lid handle and turn it counter-clockwise to align the symbol on the lid ▼ with the symbol on the rim of the multi-cooker base ↻▲.
- 02** Lift the lid up and off the multi-cooker base towards your body.

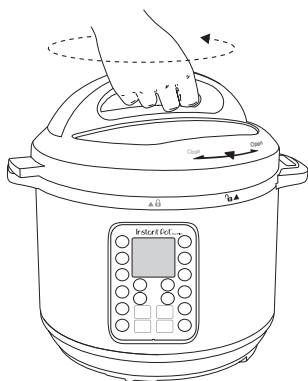

Closing the lid

- 01** Align the symbol on the lid ▼ with the symbol on the multi-cooker base ↻▲, then lower the lid onto the track.
- 02** Turn the lid clockwise until the symbol on the lid ▼ aligns with the symbol on the multi-cooker base ↻▲.

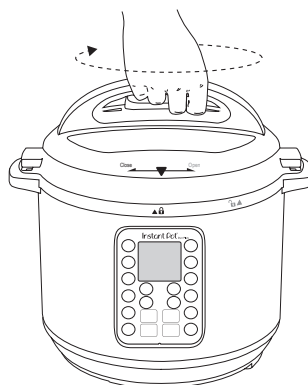

Illustrations in this document are for reference only and may differ from the actual product. Always refer to the actual product.

⚠ WARNING

Only use a compatible Instant Pot Duo Plus lid with the Instant Pot Duo Plus multi-cooker base. Using any other multi-cooker lids may cause injury and/or damage.

⚠ CAUTION

Always check the lid for damage and excessive wear prior to cooking to avoid risk of injury and/or property damage.

Pressure control features

Quick release switch

The quick release switch controls the steam release valve – the part that releases pressure.

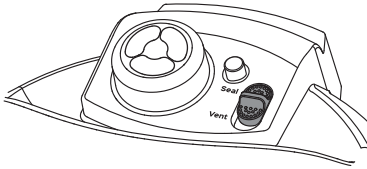

Seal position

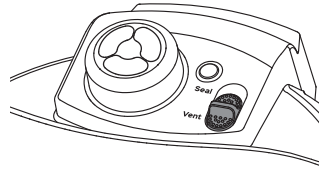

Vent position

What we love about it	What we should know about it
It's <i>super</i> easy to use, and keeps our hands far away from the steam when the multi-cooker is releasing pressure!	It automatically sets to Seal when you close the lid, so make sure to move it to Vent when you're not pressure cooking.

See **Releasing pressure: Venting methods** for safe depressurisation techniques.

Steam release valve

The steam release valve sits loosely on the steam release pipe.

When the multi-cooker releases pressure, steam ejects from the top of the steam release valve. The steam release valve is integral to product safety and necessary for pressure cooking.

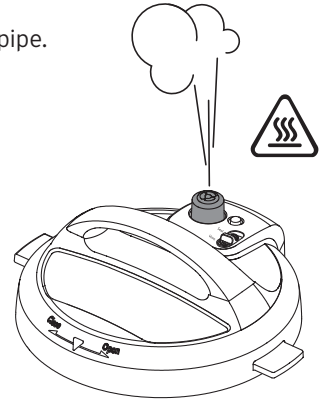

⚠ WARNING
Do not cover or block the steam release valve in any way to avoid risk of personal injury and/or property damage.

Pressure control features

Sealing ring

When the multi-cooker lid is closed, the sealing ring creates an airtight seal between the lid and the inner pot.

The sealing ring must be installed before using the multi-cooker. Only one sealing ring should be installed in the lid at a time.

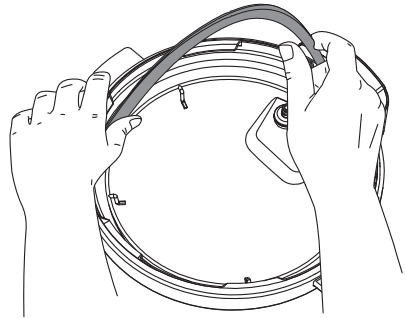

 **Instant Tip:** Silicone is porous, so it absorbs strong aromas and certain flavours. Keep extra sealing rings on hand to limit the transfer of aromas and flavours between dishes.

CAUTION

Only use authorised Instant Pot sealing rings. **DO NOT** use a stretched or damaged sealing ring.

- Always check for cuts, deformation and correct installation of the sealing ring before cooking.
- Sealing rings stretch over time with normal use. The sealing ring should be replaced every 12 to 18 months or sooner if you notice stretching, deformation, or damage.

Failure to follow these instructions may cause food to discharge, which may lead to personal injury and/or property damage.

Anti-block shield

The anti-block shield prevents food particles from coming up through the steam release pipe, assisting with pressure regulation.

The anti-block shield is integral to product safety and necessary for pressure cooking.

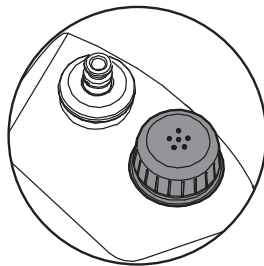

Pressure control features

Float valve

The float valve is a visual indication of whether there is pressure in the multi-cooker (pressurised) or not (depressurised). It appears in two positions:

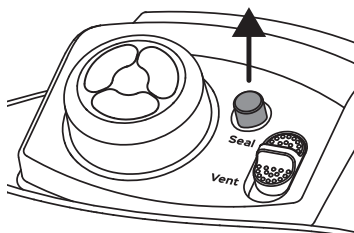

Pressurised

The float valve has visibly popped up above the surface of the lid.

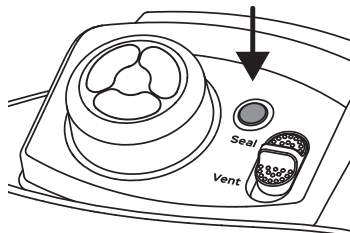

Depressurised

The float valve has descended, and the top is flush with the lid.

The float valve and silicone cap work together to seal in pressurised steam. These parts must be installed before use. Do not attempt to operate the Instant Pot without the float valve properly installed. **Do not touch the float valve during use.**

Illustrations in this document are for reference only and may differ from the actual product. Always refer to the actual product.

⚠ DANGER

DO NOT attempt to remove the lid while the float valve is up and NEVER attempt to force the lid open. Contents are under extreme pressure. Float valve must be down before attempting to remove the lid. Failure to follow these instructions may result in serious personal injury and/or property damage.

Pressure cooking Smart Programmes

Whether you're a whiz in the kitchen or a complete newbie, these Smart Programmes help get you cooking with the touch of a button.

- Pressure Cook
- Soup/Broth
- Cake
- Egg
- Rice
- Bean/Grain
- Porridge/Oatmeal
- Sterilise

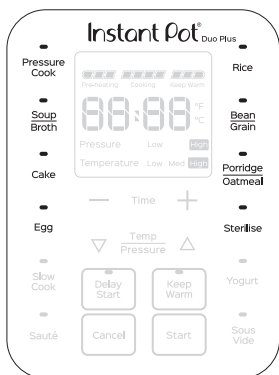

Using pressurised steam guarantees your dish is cooked evenly and deeply, for the delicious results you expect every time.

Pressure level	Suggested use	Notes
Low Pressure 5.1 - 8 psi (35 - 55 kPa)	Fish and seafood, soft vegetables and rice.	The pressure level controls the temperature, so a higher pressure results in a higher cooking temperature.
High Pressure 9.4 - 12.3 psi (65 - 85 kPa)	Eggs, meat, poultry, root vegetables, oats, beans, grains, bone broth, stew, chili.	



Instant Tip: Use the steam rack to keep foods out of the cooking liquid. This helps to distribute heat, prevents nutrients from leeching into the cooking liquid, and, stops food items from sticking to the bottom of the inner pot.

⚠ WARNING

Always cook with the inner pot in place. Food must be placed in the inner pot. **DO NOT pour food or liquid into the multi-cooker base.**

To avoid risk of personal injury and/or property damage, place food and liquid ingredients in the inner pot, then insert the inner pot into the multi-cooker base.

Do not fill inner pot higher than the **PC MAX — 2/3** (Pressure Cooking Maximum) line as indicated on the inner pot.

When cooking foods that **foam or froth** (e.g., applesauce, cranberries or split peas) or **expand** (e.g., oats, rice, beans, pasta) do not fill the inner pot higher than the **— 1/2** line as indicated on the inner pot.

⚠ CAUTION

Always inspect the lid and inner pot carefully to make sure they are clean and in good working condition before use.

- To avoid personal injury or damage to the appliance, replace the inner pot if it is dented, deformed or damaged.
 - Use only authorised Instant Pot inner pots made for this model when cooking.
- Always make sure the inner pot and heating element are clean and dry before inserting the inner pot into the multi-cooker base.

Failure to follow these instructions may damage the multi-cooker. Replace damaged parts to ensure safe function.

Pressure cooking

To create steam, pressure cooking liquids should be water-based, such as broth, stock, soup or juice. If using canned, condensed or cream-based soup, add water as directed below.

Instant pot size	Minimum liquid for pressure cooking
3 Litres	1 cup (250 mL)
5.7 Litres	1½ cup (375 mL)
8 Litres	2 cups (500 mL)

**Unless otherwise specified by your recipe.*

CAUTION

To avoid scorching or scalding injury, be cautious when cooking with more than 1/4 cup (60 mL) oil, oil-based sauces, condensed cream-based soups, and thick sauces. Add suitable liquid to thin sauces. Avoid recipes that call for more than 1/4 cup (60 mL) of oil or fat content.

Using pressure cooking Smart Programmes

Stage 1: Setting up the Duo Plus for pressure cooking

- 01** Remove the inner pot from the multi-cooker base.
Add food and liquid ingredients to the inner pot, as directed by your recipe.
Insert the inner pot back into the multi-cooker base.
- 02 3L & 5.7L only:** Secure the power cord to the base power socket on the back of the multi-cooker base. Make sure the connection is tight.
All sizes: Connect the power cord to a 220-240V power source.
The display shows **OFF**.
- 03** Place and close the lid as described in **Pressure control features: multi-cooker lid**.

Stage 2: Pressure cooking

- 01** Select the Smart Programme you want to use (see previous page).
- 02** Use the **- / + Time** buttons to adjust the cooking time.
- 03** Use the **Temp / Pressure** buttons to select **Low** or **High** pressure.
 Adjustments are saved to the Smart Programme when cooking begins.
- 04** Leave the automatic Keep Warm setting on, or press **Keep Warm** to turn it off.
- 05** Press **Start** to begin. The display shows **On** while the multi-cooker preheats.
- 06** When the Smart Programme finishes, follow your recipe's directions to select the appropriate venting method. See **Releasing pressure: Venting methods** for safe venting techniques.

DANGER

DO NOT attempt to remove the lid while the float valve is up and NEVER attempt to force the lid open. Contents are under extreme pressure. Float valve must be down before attempting to remove the lid. Failure to follow these instructions may result in serious personal injury and/or property damage.

Pressure cooking

Smart Programme details

Smart Programmes	Default time	Time range	Default pressure level	Notes and tips
Pressure Cook	10 minutes (00:10)	1 minute to 8 hours (00:01 to 08:00)	High	Flexible manual programming.
Soup/Broth	30 minutes (00:30)	1 minute to 4 hours (00:01 to 04:00)	High	Liquid remains clear due to lack of boiling motion. Always use NR to release pressure when cooking soup with a high starch content.
Cake	30 minutes (00:30)	1 minute to 4 hours (00:01 to 04:00)	High	Adjust cook time as directed in recipe. Cake batter should be poured into a springform pan and covered with foil. Leave 2.5cm of space around the pan to ensure heat circulates properly.
Egg	5 minutes (00:05)	1 minute to 1 hour (00:01 to 01:00)	High	Preset times are intended for extra large eggs. Adjust cooking time to account for different sized eggs. Plunge eggs into ice bath to prevent overcooking.
Rice	12 minutes (00:12)	1 minute to 1 hour (00:01 to 01:00)	Low	For cooking medium and long-grain white rice. Use a 10-minute Natural Release after cooking for perfect results.
Bean/Grain	20 minutes (00:20)	1 minute to 1 hour (00:01 to 01:00)	High	When cooking beans or legumes, always use NR to release pressure. Make sure dry beans are completely submerged in water.
Porridge/Oatmeal	5 minutes (00:05)	1 minute to 1 hour (00:01 to 01:00)	High	Adjust time as directed in recipe. Always use NR to release pressure when cooking foods that expand.
Sterilise	15 minutes (00:15)	1 minute to 1 hour (00:01 to 01:00)	High	Sterilise utensils, tempered glass, and some heat-resistant plastics. Low and High pressure hot water bath canning of acidic fruits and vegetables.

Pressure cooking

Pressure cooking grains

Download the free Instant Brands Connect app to search recipes, save favourites, make notes and more!

Rice and grain	Grain to water ratio
White or brown rice	1 cup : 1 cup
Quinoa	1 cup : 3/4 cup
Oatmeal	1 cup : 3 cups
Porridge	1 cup : 10 cups
Risotto	1 cup : 2 cups Add additional wine to taste

CAUTION

When cooking meat, always use a meat thermometer to ensure the internal temperature reaches a safe minimum temperature.

Other cooking Smart Programmes

The Duo Plus is much more than a pressure cooker. These Smart Programmes don't cook with pressure, but are just as easy to use and give you delicious results.

- Slow Cook
- Sauté
- Yogurt
- Sous Vide

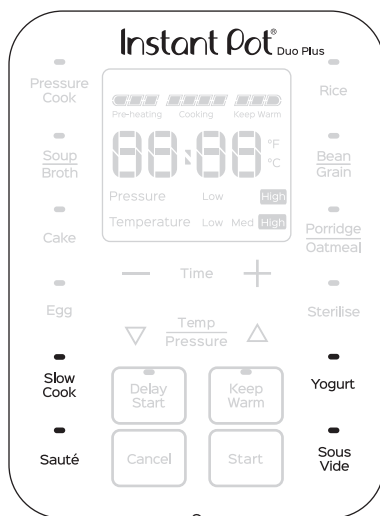

⚠ WARNING

Always cook with the inner pot in place. Food must be placed in the inner pot. **DO NOT pour food or liquid into the multi-cooker base.**

To avoid risk of personal injury and/or property damage, place food and liquid ingredients in the inner pot, then insert the inner pot into the multi-cooker base.

Do not fill inner pot higher than the **PC MAX — 2/3** (Pressure Cooking Maximum) line as indicated on the inner pot.

When cooking foods that **foam or froth** (e.g., applesauce, cranberries or split peas) or **expand** (e.g., oats, rice, beans, pasta) do not fill the inner pot higher than the **— 1/2** line as indicated on the inner pot.

⚠ CAUTION

Always inspect the lid and inner pot carefully to make sure they are clean and in good working condition before use.

- To avoid personal injury or damage to the appliance, replace the inner pot if it is dented, deformed or damaged.
 - Use only authorised Instant Pot inner pots made for this model when cooking.
- Always make sure the inner pot and heating element are clean and dry before inserting the inner pot into the multi-cooker base.

Failure to follow these instructions may damage the multi-cooker. Replace damaged parts to ensure safe function.

Other cooking Smart Programmes

Slow Cook

Slow Cook is compatible for use with any common slow cooker recipe, so you can keep cooking your classics!

 If the float valve rises, make sure the quick release switch is set to **Vent**. See **Pressure control features: Quick release switch**.

Default time	Time range	Default temperature	Temperature range	Notes and tips
6 hours (06:00)	30 minutes to 24 hours (00:30 to 24:00)	Med	Low Med High	Less is commonly used for low and slow, all-day cooking, and should be set for a minimum of 10 hours (10:00) for best results. You can use a glass lid for slow cooking if it has a venting hole.

Stage 1: Setting up the Duo Plus for slow cooking

- 01** Remove the inner pot from the multi-cooker base.
Add food and liquid ingredients to the inner pot.
Insert the inner pot into the multi-cooker base.
- 02 3L & 5.7L only:** Secure the power cord to the base power socket on the back of the multi-cooker base. Make sure the connection is tight.
All sizes: Connect the power cord to a 220-240V power source.
The display shows **OFF**.
- 03** Place and close the lid as described in **Pressure control features: multi-cooker lid**, or use a glass lid with a venting hole.
- 04** Move the quick release switch to the **Vent** position.

Stage 2: Slow cooking

- 01** Press **Slow Cook**.
- 02** Use the **- / + Time** buttons to adjust the cooking time.
- 03** Use the **Temp / Pressure** buttons to select a **Low**, **Med** or **High** temperature.
 Cooking time and temperature level adjustments are saved to the Smart Programme when cooking begins.
- 04** Leave the automatic **Keep Warm** setting on, or press **Keep Warm** to turn it off.
- 05** Press **Start** to begin. The display timer counts down.

When cooking completes, the display shows **End** if **Keep Warm** is turned off. If not, the timer begins counting from **00:00** up to 10 hours **(10:00)**.

Other cooking Smart Programmes

Sauté

Sauté can be used in place of a frying pan, griddle or flat-top grill.

Default time	Time range	Default temperature	Temperature range	Notes and tips
30 minutes (00:30)	1 minute to 1 hour (00:01 to 01:00)	High	Low	Simmering, thickening, and reducing liquids.
			Med	Pan searing or sautéing.
			High	Stir-frying or browning meat.

Stage 1: Setting up the Duo Plus for sautéing

- 01** Insert the inner pot into the multi-cooker base. **Do not use a lid.**
- 02 3L & 5.7L only:** Secure the power cord to the base power socket on the back of the multi-cooker base. Make sure the connection is tight.
All sizes: Connect the power cord to a 220-240V power source.
The display shows **OFF**.
- 03** Press **Sauté**.
- 04** Use the **- / + Time** buttons to adjust the cooking time.
 Cooking time and temperature level adjustments are saved to the Smart Programme when cooking begins.
- 05** Use the **Temp / Pressure** buttons to select a **Low, Med** or **High** temperature.
- 06** Press **Start** to begin. The multi-cooker displays **On** to indicate that it has begun heating.

Stage 2: Sautéing

- 07** When the display switches from **On** to **Hot**, add your recipe ingredients.
 If recipe ingredients are added before the Hot message appears, it may not appear at all. This is normal!
- 08** If you finish sautéing before the timer runs out, press **Cancel**. Otherwise, when cooking finishes the display shows **End**.

Delay Start and Automatic Keep Warm are not available on the Sauté Smart Programme.

WARNING

The Sauté Smart Programme reaches high temperatures. If unmonitored, food may burn on this setting. Do not use the lid and do not leave your multi-cooker unattended while using Sauté.

Other cooking Smart Programmes

Deglazing the inner pot (pressure cooking after sauté)

Sautéing meat and vegetables before pressure cooking is the perfect way to boost flavours, as sugars caramelize from the high heat of the Sauté Smart Programme.

When pressure cooking after using Sauté, deglaze the inner pot to make sure food items do not scorch.

To deglaze: Remove food items from the inner pot and add a thin liquid (such as, water, broth, wine) to the hot surface. Use a wooden or silicone scraper to loosen anything that may be stuck to the bottom of the inner pot.

Yogurt

Produce delicious fermented dairy and non-dairy recipes effortlessly.

Instant Pot Size	Minimum Milk Volume	Maximum Milk Volume
3 Litres	2 cups (500 mL)	~2.3 Litres
5.7 Litres	4 cups (1 L)	~3.8 Litres
8 Litres	6 cups (1.5 L)	~5.7 Litres

Default temperature	Temperature range	Default time	Time range	Notes and tips
High	Low	24 hours (24:00)	30 minutes to 99 hours and 30 minutes (00:30 to 99:30)	For lower temperature fermentation (such as, Jiu niang, a sweet fermented glutinous rice dessert).
	Med	8 hours (08:00)	30 minutes to 99 hours and 30 minutes (00:30 to 99:30)	Fermenting milk after culture has been added.
	High	(boil)	Not adjustable.	Pasteurising milk.

Other cooking Smart Programmes

Stage 1: Pasteurise milk

- 01** Remove the inner pot from the multi-cooker base.
- 02** Add unpasteurised milk to the inner pot then insert the inner pot into the multi-cooker base.
- 03 3L & 5.7L only:** Secure the power cord to the base power socket on the back of the multi-cooker base. Make sure the connection is tight.
All sizes: Connect the power cord to a 220-240V power source.
The display shows **OFF**.
- 04** Place and close the lid as described in **Pressure control features: multi-cooker lid**.
- 05** Press **Yogurt**. Leave temperature on **High**.
- 06** Use the **Temp / Pressure** buttons to select **High** temperature.
- 07** Press **Start** to begin. The multi-cooker begins heating and the display shows **boil**.
- 08** When pasteurisation finishes, the display shows **End**.

Remove the lid and use a thermometer to check the temperature.

-  Milk must reach a minimum of 72°C for pasteurisation to occur.

Stage 2: Add starter culture

- 01** Allow pasteurised milk to cool to just below 43°C.
- 02** Add a starter culture to the milk according to package instructions.
 If using plain yogurt as a starter, make sure that it contains an **active culture**. Mix in 30 mL (2 tbsp) of yogurt per 3.7 L of milk, or follow a trusted recipe.
- 03** Place and close the lid as described in **Pressure control features: Multi-cooker lid**.

Stage 3: Ferment yogurt

- 01** Press **Yogurt**.
- 02** Use the **Temp / Pressure** buttons to select **Med** temperature. The display shows **08:00**.
- 03** Use the **- / + Time** buttons to adjust the fermentation time if desired.
A longer fermentation period will give you tangier yogurt.

- 04** Press **Start** to begin. The multi-cooker begins heating. The display timer counts up to the set time from **00:00**.
- 05** When fermentation completes, the multi-cooker beeps and displays **End**.

-  **Instant Tip:** Allow the yogurt to cool, then place it in your fridge for 12 to 24 hours to allow the flavours to develop!

Other cooking Smart Programmes

Using yogurt cups

Yogurt cups are a convenient way to portion out yogurt servings.

- 01** After adding the starter culture to your pasteurised milk, carefully pour the milk into your yogurt cups and seal them tightly.
- 02** Clean the inner pot thoroughly and place the steam rack on the bottom of the inner pot.
- 03** Place the sealed yogurt cups on the steam rack and add water to the inner pot until the cups are immersed halfway.
- 04** Follow the steps in **Stage 3: Ferment Yogurt**.

Sous Vide

Sous Vide cooking involves cooking food underwater in an airtight, food-safe bag, for a long period of time. Food cooks in its own juices and comes out delicious and unbelievably tender.

Default temperature	Temperature range	Default time	Time range	Notes and tips
56°C	25 to 90°C	3 hours (03:00)	30 minutes to 99 hours and 30 minutes (00:30 to 99:30)	Separating servings can help you accommodate unique dietary restrictions.

You'll need:

- Tongs
- Thermometer
- Food safe, airtight, re-sealable food pouches, or,
- Vacuum sealer and food-safe vacuum bags

Other cooking Smart Programmes

Stage 1: Setting up the sous vide water bath

- 01 Remove the inner pot from the multi-cooker base.

Fill the inner pot with warm water up to – **1/2 line**, as indicated on the inner pot.

Insert the inner pot into the multi-cooker base.

- 02 **3L & 5.7L only:** Secure the power cord to the base power socket on the back of the multi-cooker base. Make sure the connection is tight.

All sizes: Connect the power cord to a 220-240V power source.

The display shows **OFF**.

- 03 Place and close the lid as described in **Pressure control features: multi-cooker lid**, or use a glass lid with a venting hole.
- 04 Move the quick release switch to the **Vent** position.

Stage 2: Setting up the Duo Plus for sous vide cooking

- 01 Press **Sous Vide**.
- 02 Use the **Temp / Pressure** buttons to set a custom temperature.
- 03 Use the **- / + Time** buttons to adjust the cooking time.

 Cooking time and temperature adjustments are saved to the Smart Programme when cooking begins.

- 04 Press **Start** to begin. The multi-cooker displays **On**.

Stage 3: Getting food ready

- 01 While the water heats, season your food as desired.

See **Ingredients and seasonings** for tips!

- 02 When you're ready, separate each serving of food into individual pouches.
- 03 Remove all air from the pouches and seal them tightly.

Stage 4: Cook 'em up!

- 01 Once the water bath is ready, the display shows **Hot** for a few moments before switching over to the countdown timer.

- 02 Remove the lid and carefully immerse the sealed pouches in the water.

 The food in the pouches should be submerged, so add heated water to the inner pot any time it's needed, *but*, if you're using a re-sealable bag, make sure the seal stays above the water.

- 03 Place and close the Multi-cooker lid as described in **Pressure control features: multi-cooker lid**.
- 04 When the Smart Programme finishes the display shows **End**. Open the multi-cooker and use your tongs to carefully remove the pouches from the hot water.
- 05 Open the pouches and use a thermometer to check for doneness.

Other cooking Smart Programmes

Reverse searing

Searing your meat after low and slow cooking is the easiest way to boost those already-delicious flavours through the roof *without* overcooking. Try reverse searing for tender, juicy meat with a beautiful burnished crust.

01 After Sous Vide cooking, remove the meat from the cooking pouch and gently pat it dry to remove as much moisture as you can from the exterior of the meat.

 It may seem crazy to remove juices, but don't skip this step – you'll end up with more flavour and a great looking finish!

02 Use the Sauté Smart Programme to give it a good sear, or, use a cast iron pan, browning torch, or a grill – anything hot to lock in that moisture!

 In general, after sautéing, steaks need to rest to allow the internal temperature to even out. However, with sous vide cooking, the internal temperature is already consistent. So there's no need to rest—you can serve your steak immediately.

Ingredients and seasonings

- Salt goes a long way when it has nowhere to go, so it's better to use a little less than you normally would, especially with meats, poultry and fish. If you find it needs more after cooking, salt to taste!
- Use high quality, fresh ingredients when cooking sous vide to ensure the best possible flavour.
- Use fresh garlic rather than garlic powder. Garlic powder can become overpowering when cooked sous vide.

Storing cooked food

If you're not going to eat right away, plunge the unopened pouches into ice water to reduce the temperature quickly, then keep them refrigerated until you're ready.

Check out the **sous vide cooking times** online!

CAUTION

Do not overfill the inner pot to avoid property damage. Total contents (water and food pouches) should leave at least 5 cm of headspace between the water line and the brim of the inner pot.

CAUTION

When cooking meat, always use a meat thermometer to ensure the internal temperature reaches a safe minimum temperature.

Care, cleaning and storage

Clean your Duo Plus and its parts after each use. Failure to follow these cleaning instructions may result in catastrophic failure, which may lead to property damage and/or severe personal injury.

Always unplug your multi-cooker and let it cool to room temperature before cleaning. Never use metal scouring pads, abrasive powders or harsh chemical detergents on any of the Instant Pot's parts or accessories.

Let all surfaces dry thoroughly before use, and before storage.

Parts	Cleaning methods and instruction
Accessories <ul style="list-style-type: none"> • Steam rack 	Dishwasher safe.
Lid and parts <ul style="list-style-type: none"> • Anti-block shield • Sealing rings • Steam release valve • Float valve • Silicone cap • Condensation collector 	Dishwasher safe if placed on the top rack. Remove all the parts from the lid before cleaning. See Care, cleaning and storage: Removing and installing parts. <ul style="list-style-type: none"> • With steam release valve and anti-block shield removed, clean the interior of the steam release pipe to prevent clogging. • To drain water from the lid after dishwashing, grasp the lid handle and hold the lid vertically over a sink, then turn it 360° – like turning a steering wheel. • After cleaning, store the lid upside down on the multi-cooker base. • Store sealing rings in a well-ventilated area to decrease residual odour of flavourful meals. To eliminate odours, add 1 cup (250 mL) water and 1 cup (250 mL) white vinegar to the inner pot, and run Pressure Cook for 5-10 minutes, then QR pressure. • Check the condensation collector after each use and empty as needed. Do not allow food or moisture to stagnate in the condensation collector.
Inner pot	Dishwasher safe. <ul style="list-style-type: none"> • More acute hard water staining may require a vinegar-dampened sponge and some scrubbing to remove. • If there is tough or burned food residue at the bottom, soak in hot water for a few hours for easy cleaning. • Make sure all exterior surfaces are dry before placing in the multi-cooker base.
Power cord	Hand wash only. Do not machine wash. <ul style="list-style-type: none"> • Use a barely damp cloth to wipe any particles off the cord.  3L & 5.7L power cords are detachable for storage.
Multi-cooker base	Hand wash only. Do not machine wash. <ul style="list-style-type: none"> • Clean the multi-cooker base and control panel with a soft, barely damp cloth or sponge. • Wipe the inside of the multi-cooker base, the heating element, and the condensation rim with a barely damp cloth. Allow them to dry completely before inserting the inner pot.

Some discolouration may occur after machine washing, but this will not affect the multi-cooker's safety or performance.

Care, cleaning and storage

⚠ WARNING

The Instant Pot multi-cooker base contains electrical components. To avoid fire, electric leakage or personal injury, make sure the multi-cooker base stays dry.

- DO NOT immerse the multi-cooker base in water or other liquid, or attempt to cycle it through the dishwasher.
- DO NOT rinse the heating element.
- DO NOT submerge or rinse the power cord or the plug.

Removing and installing parts

Silicone sealing ring

Remove the sealing ring

Grip the edge of the silicone and pull the sealing ring out from behind the circular stainless-steel sealing ring rack.

With the sealing ring removed, inspect the steel rack to make sure it is secured, centered, and at an even height all the way around the lid. Do not attempt to repair a deformed sealing ring rack.

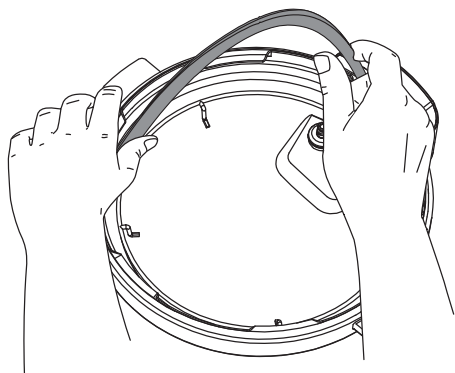

Install the sealing ring

Place the sealing ring over the sealing ring rack and press it into place. Press down firmly to prevent puckering.

When installed properly, the sealing ring is snug behind sealing ring rack and should not fall out when the lid is turned over.

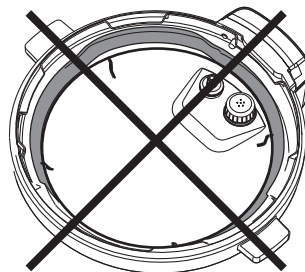
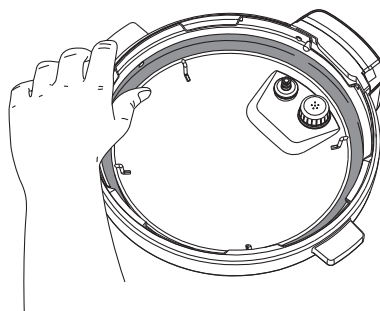

Incorrect

Illustrations in this document are for reference only and may differ from the actual product. Always refer to the actual product.

Care, cleaning and storage

Steam release valve

Remove the steam release valve

Pull the steam release valve up and off the steam release pipe.

The steam release valve must be installed before using the multi-cooker.

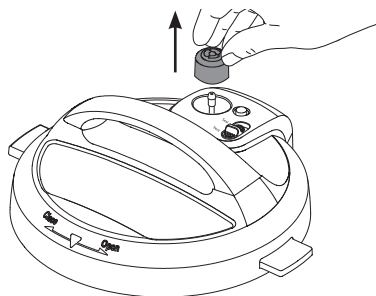

Install the steam release valve

Place the steam release valve on the steam release pipe and press down firmly.

The steam release valve sits loosely on the steam release pipe when installed properly but should remain in place when the lid is turned over.

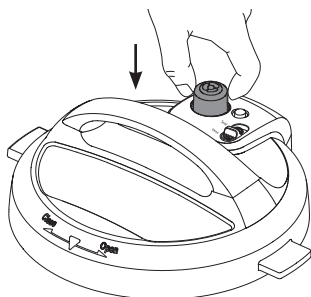

Anti-block shield

Remove the anti-block shield

Grip the lid like a steering wheel and use your thumbs to press firmly against the side of the anti-block shield (pressing towards the side of the lid and up) until it pops off the prongs underneath.

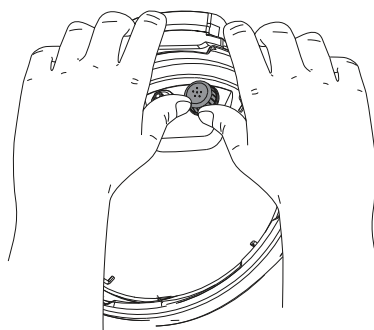

Install the anti-block shield

Place the anti-block shield over the prongs and press down until it snaps into position.

Do not attempt to operate the multi-cooker without the anti-block shield installed.

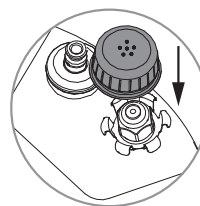

Illustrations in this document are for reference only and may differ from the actual product. Always refer to the actual product.

Care, cleaning and storage

Float valve and silicone cap

Remove the float valve

Place one finger on the flat top of float valve, then turn the lid over. Detach the silicone cap from the bottom side of the float valve. Remove the float valve from the top of the lid.

 Do not discard the float valve or silicone cap.

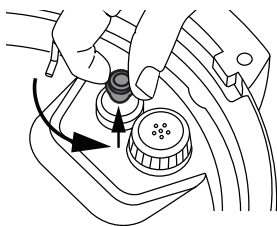

Install the float valve

Drop the narrow end of the float valve into the float valve hole on the top of the lid. Place one finger on the flat top of the float valve, then turn the lid over. Firmly attach the silicone cap to the bottom of the float valve.

Do not attempt to operate the multi-cooker without the float valve and/or silicone cap properly installed in the multi-cooker lid.

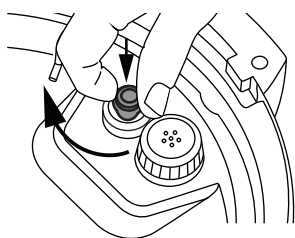

Condensation collector

The condensation collector sits at the back of the multi-cooker base and catches any overflow from the condensation rim.

It should be installed before cooking, then emptied and rinsed out after each use.

Remove the condensation collector

Pull the condensation collector away from the multi-cooker base; **do not pull down**. Note the tabs on the multi-cooker base and the grooves on the condensation collector.

Install the condensation collector

Align the grooves on the condensation collector over the tabs on the back of the multi-cooker base and slide the condensation collector into place.

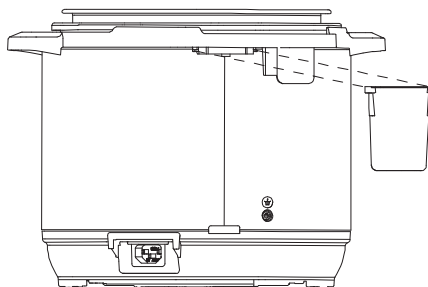

Illustrations in this document are for reference only and may differ from the actual product. Always refer to the actual product.

Troubleshooting

Register your Instant Pot Duo Plus today at instantpot.com.au/support/register.

Get in touch with Customer Care by email at support@instantpot.com.au or by phone at 1800 251 643 or (02) 9317 1000.

Problem	Possible reason	Try this
Occasional clicking or light cracking sound.	The sound of power switching and expanding pressure board when changing temperatures.	This is normal; no action needed.
	Bottom of the inner pot is wet.	Wipe exterior surfaces of the inner pot. Make sure the heating element is dry before inserting the inner pot back into the multi-cooker base.
Difficulty closing the lid.	Sealing ring is not properly installed.	Reposition the sealing ring. Make sure it is snug behind the sealing ring rack.
	Float valve is in the popped-up position.	Gently press the float valve downward with a long utensil.
	Contents in multi-cooker are still hot.	Hold the quick release switch in the Vent position as you lower the lid onto the multi-cooker base slowly, allowing heat to dissipate.
Difficulty opening the lid.	⚠ DANGER Contents may be under pressure. To avoid scalding injury, DO NOT attempt to force the lid open.	
	Pressure inside the multi-cooker.	Release pressure according to recipe. Only open the lid after the float valve has dropped down.
	Float valve stuck in the popped-up position due to food debris or residue.	Release pressure completely, then tap the float valve gently with a long utensil. Open the lid cautiously, then thoroughly clean the float valve, surrounding area, and lid before next use.
The inner pot is stuck to the lid when the multi-cooker is opened.	Cooling of the inner pot may create suction, causing the inner pot to adhere to the lid.	To release the vacuum, move the quick release switch to the Vent position.

Troubleshooting

Problem	Possible reason	Try this
Steam leaks from side of lid.	No sealing ring in the lid.	Install a sealing ring.
	The sealing ring is damaged or not installed properly.	Replace the sealing ring.
	Food debris attached to the sealing ring.	Remove the sealing ring and clean it thoroughly.
	The lid is not closed properly.	Open, then close the lid.
	The sealing ring rack is warped or off-centre.	Remove the sealing ring from the lid, then check the sealing ring rack for bends or warps. Contact Customer Care .
	The inner pot rim may be misshapen.	Check for deformation and contact Customer Care .
The float valve does not rise.	Food debris on the float valve or float valve silicone cap.	Remove the float valve from the lid and clean it thoroughly. Perform the Initial test run to check for function and record your findings. Contact Customer Care .
	Too little liquid in the inner pot.	Check for scorching on the bottom of the inner pot. Add thin, water-based liquid to the inner pot according to its size. 3L: 1 cup (250 mL) 5.7L: 1 ½ cups (375 mL) 8L: 2 cups (500 mL)
	Float valve's silicone cap is damaged or missing.	Install or replace the float valve and/or silicone cap.
	Float valve obstructed by lid-locking mechanism.	Tap the float valve with a long utensil. If the float valve does not drop, turn the multi-cooker off. Contact Customer Care .
	No heat in the inner pot.	Perform the Initial test run to check for function and record your findings. Contact Customer Care .
	Inner pot base may be damaged.	Perform the Initial test run to check for function and record your findings. Contact Customer Care .
	Minor steam leaking or hissing from the steam release valve during the cook cycle.	Quick release switch is not in the Seal position.
Multi-cooker is regulating excess pressure.		This is normal; no action required.
The display remains blank after connecting the power cord.	Bad power connection or no power.	Ensure power connection to base is tight (3L & 5.7L only). Check outlet to make sure it is powered. Inspect power cord for damage. If damage is noticed, contact Customer Care .
	Multi-cooker's electrical fuse has blown.	Contact Customer Care .

Troubleshooting

Problem	Possible reason		Try this
Steam gushes from the steam release valve when the quick release switch is in the Seal position.	Not enough liquid in the inner pot.		Add thin, water-based liquid to the inner pot according to its size. 3L: 1 cup (250 mL) 5.7L: 1 ½ cups (375 mL) 8L: 2 cups (500 mL)
	Pressure sensor control failure.		Contact Customer Care .
	Steam release valve is not seated properly.		Move the steam release switch to Vent then back to the Seal position.
Error code appears on the display and the multi-cooker beeps continuously.	C1 C2 C6 C6H C6L	Faulty sensor.	Contact Customer Care .
	C5	Temperature is too high because the inner pot is not placed in the multi-cooker base.	Press Cancel and wait for heating element to cool; make sure there are no foreign objects in multi-cooker base; insert or reposition inner pot in multi-cooker base and re-enter commands.
		Temperature is too high.	Check for scorching on bottom of inner pot. Add thin, water-based liquid to the inner pot according to its size. 3L: 1 cup (250 mL) 5.7L: 1 ½ cups (375 mL) 8L: 2 cups (500 mL)
	C7	Heat element has failed.	Contact Customer Care .
		Not enough liquid.	Add thin, water-based liquid to the inner pot according to its size. 3L: 1 cup (250 mL) 5.7L: 1 ½ cups (375 mL) 8L: 2 cups (500 mL)
		Quick release switch is in the Vent position.	Move the quick release switch to the Seal position.
	Lid	Lid is not in the correct position for the selected programme.	Open and close the lid.
			Do not use a lid when using Sauté.
Error code appears on the display and the cooker beeps continuously.	Food burn	High temperature detected at bottom of inner pot; the multi-cooker automatically reduces the temperature to avoid overheating.	Starch deposits at the bottom of the inner pot may have blocked heat dissipation. Turn the multi-cooker off, release pressure according to the recipe, and inspect the bottom of the inner pot.
	PrSE	Pressure has accumulated during a non-pressure cooking programme.	Move the quick release switch to the Vent position.

Any other servicing must be performed by an authorised representative.

Warranty

Limited Warranty

This Limited Warranty is issued by Corelle Brands (Australia) Pty Ltd (Corelle Brands Australia) and is effective for one year from the date of original consumer purchase. Proof of original purchase date and return of your appliance is required to obtain service under this Limited. Return of your appliance to us will be done in accordance with our instructions only. Provided that this appliance is operated and maintained in accordance with written operating instructions attached to or furnished with the appliance or published operating instructions on www.instantpot.com.au, Corelle Brands Australia will, in its sole and exclusive discretion, either: (i) repair defects in materials or workmanship; or (ii) replace the appliance. In the event that your appliance is replaced, the Limited Warranty on the replacement appliance will expire 12 months from the date of original consumer purchase.

We remind you the appliance you purchased is for personal use only (not commercial use).

Any modification/alteration or attempted modification/alteration to your appliance will void this Limited Warranty, unless such modification/alteration or attempted modification/alteration was expressly authorised by a Corelle Brands Australia Representative in writing.

This Limited Warranty only covers Corelle Brands Australia's appliances/products and is not extended to any other appliances, products, equipment, components, or devices that you use or may use in conjunction with the Corelle Brands Australia's appliances.

To claim under this Limited Warranty:

1. Contact Corelle Brands Australia at:
Sydney Corporate Park
Level 1, 184 Bourke Road, Alexandria, NSW 2015
Email: sales.australia@instantbrands.com
2. Provide a description of the appliance you believe has malfunctioned due to defective parts or workmanship.
3. If it is necessary for the appliance to be sent to Corelle Brands Australia for repair or replacement, Corelle Brands Australia will send you a pre-paid shipping label and you must send the appliance and your dated sales receipt to Corelle Brands Australia along with the appliance. If you do not have your dated sales receipt, please advise Corelle Brands Australia in advance, and Corelle Brands Australia will attempt to verify your purchase.
4. If Corelle Brands Australia determines that the appliance has malfunctioned due to defective parts or workmanship, and is covered under this Limited Warranty, Corelle Brands Australia will repair and return the appliance, or send you a replacement appliance, at Corelle Brands Australia's cost.
5. Any repaired or replaced appliance will be covered by this Limited Warranty for the remainder of the original warranty period or ninety (90) days following your receipt of the replacement or repaired appliance, whichever is greater.

Warranty

6. If Corelle Brands Australia confirms the appliance has not malfunctioned due to defective parts or workmanship, and/or is in working order, or if proof of purchase is not verified, Corelle Brands Australia reserves the right to return the appliance to you at your pre-paid cost. If this cost is not met, Corelle Brands Australia reserves the right to dispose of the appliance after 45 days' notice to you.

Limitation and Exclusions

To the maximum extent permitted by law, the maximum liability of Corelle Brands Australia, if any, for any allegedly defective appliance or part shall in no circumstances exceed the purchase price of a comparable replacement appliance or part of the same age.

This Limited Warranty does not cover:

Damage resulting from accident, modification/alteration (unless expressly authorised by a Corelle Brands Australia Representative in writing), misuse, abuse, neglect, unreasonable use, use contrary to the written operating instructions attached to or furnished with the appliance or published operating instructions on www.instantpot.com.au, normal wear and tear, commercial use, improper assembly by you or anyone, disassembly by you or anyone, repair by you or anyone, failure to provide reasonable and necessary maintenance, force majeure event including but not limited to fire, flood, acts of God;

Repairs where your appliance is used for other than normal, personal use or when it is used in a manner that is contrary to the written operating instructions attached to or furnished with the appliance or published operating instructions on www.instantpot.com.au ; or

Use of unauthorised parts and accessories, or repairs to parts and systems resulting from unauthorised repairs or modifications/alterations made to your appliance.

The cost of repair or replacement under these excluded circumstances shall be borne by you. Our goods come with guarantees that cannot be excluded under the Australian Consumer Law. You are entitled to a replacement or refund for a major failure and compensation for any other reasonably foreseeable loss or damage. You are also entitled to have the goods repaired or replaced if the goods fail to be of acceptable quality and the failure does not amount to a major failure.

Distributed by Corelle Brands (Australia) Pty Ltd.
Sydney Corporate Park
Level 1, 184 Bourke Road, Alexandria, NSW 2015.
1800 251 643 or (02) 9317 1000.
Email: sales.australia@instantbrands.com

©2022 Corelle Brands (Australia) Pty Ltd.
Distributed by Corelle Brands (Australia) Pty Ltd.

An Instant Brands Company.

Sydney Corporate Park
Level 1, 184 Bourke Road, Alexandria, NSW 2015, Australia.

instantpot.com.au

©2022 Instant Brands LLC.
803-0110-91