



# INSTRUCTION MANUAL

SUMMIT SERIES VERTICAL RANGE





# CONTENTS

|  |       |
|--|-------|
| 1. Preface .....                             | 3     |
| 2. Use of the equipment .....                | 3     |
| 3. Technical features .....                  | 4     |
| 4. Operation.....                            | 4     |
| 5. Control unit.....                         | 4     |
| 6. Handling.....                             | 4     |
| 7. Installation procedure.....               | 5     |
| 8. Connecting to the main power supply.....  | 5     |
| 9. Maintenance instructions .....            | 6     |
| Cleaning.....                                | 6     |
| Cleaning the refrigerator surface .....      | 6     |
| Cleaning the inside of the refrigerator..... | 6     |
| Cleaning the condenser .....                 | 6     |
| 10. Troubleshooting.....                     | 6     |
| 11. Technical service.....                   | 6     |
| 12. Configuration Sketch Map .....           | 7     |
| <br>   |       |
| Operating Instruction.....                   | 7     |
| Electrical Control Circuit Diagram.....      | 10    |
| Technical Parameters.....                    | 12    |
| Official Approval and Rules.....             | 12    |
| Warranty.....                                | 13-14 |



# INSTRUCTION MANUAL SUMMIT SERIES VERTICAL RANGE

## 1. Preface

This instruction manual provides all the necessary information regarding:

- ▲ use of the refrigerator
- ▲ technical specifications
- ▲ installation and handling
- ▲ operator procedures and instructions
- ▲ maintenance operation

The manual is to be considered an integral part of the refrigerator and should be stored in a safe place for further consultation to ensure a good working life of the refrigerator.



## ATTENTION

**The manufacturer cannot be held liable in the following cases:**

- improper installation (not in accordance with the guidelines indicated herein)
- misuse of the refrigerator
- power supply defects
- improper or inadequate maintenance
- unauthorised modification or tampering
- use of non-original spare parts
- partial or total failure to comply with the instructions

All electrical equipment can be hazardous to health. Current standards and legal requirements must be complied with during the installation and use of any equipment.

## 2. Use of the equipment

The refrigeration units are for preserving fresh perishable foodstuffs, with a in-built refrigerated unit. The operating temperature for refrigeration is:

- between  $-2^{\circ}\text{C}$  and  $+8^{\circ}\text{C}$  at room temperature of  $+32^{\circ}\text{C}$  at 60%RD.

The operating temperature for frozen food maintenance is:

- between  $-17^{\circ}\text{C}$  and  $-22^{\circ}\text{C}$  at room temperature of  $+32^{\circ}\text{C}$  at 60% RD.



## INSTRUCTION MANUAL SUMMIT SERIES VERTICAL RANGE

### 3. Technical features

The refrigerator is a ventilated system, the evaporator is in a separate insulated box on the top. All the materials used in the manufacture of this unit are guaranteed to be suitable for use with foodstuffs.

The refrigerant used in the refrigerator is R600a.

The refrigerant gas used in the freezer is R290.

The refrigerating circuit are in compliance with the current standards.

### 4. Operation

The gas in the refrigerating circuit is compressed, liquefied and then evaporated in the ventilated evaporator, situated on the top of the container.

This cycle involves the absorption of heat from the air in the refrigerator compartment. The heat produced is then dissipated to the outside environment by a condenser unit located on the top of the refrigerator.

### 5. Control unit

The refrigerator is controlled from a “digital control unit” and a “main switch pilot light” in the top panel of the refrigerator. The “main switch pilot light” is for turning the power supply on.

The green pilot light comes on to indicate that the unit is connected to the main electricity and to is starting to work.

The green pilot light comes off to indicate that the unit is disconnected or does not work. The “digital control unit” is for the regulation of all parameters to provide the correct working temperatures of the refrigerator. Please consult all “operating instructions” for use of the “digital control unit”.

### 6. Handling

The refrigerator arrives in PET film and packed in cardboard sheeting on a wooden pallet.



The refrigerator must be transported and handled with care to avoid posing a hazard to persons or property.



Never place a refrigerator with an in-built refrigerated unit on its side or turn it upside down, as this may damage or impair operation of the refrigerated unit. We can not be held liable for any damage or defects arising directly or indirectly from improper handling of the equipment or non-compliance with the safeguards illustrated above.



## INSTRUCTION MANUAL SUMMIT SERIES VERTICAL RANGE

### 7. Installation procedure

- ▲ Place the refrigerator in the coolest and best ventilated part of the room. Do not install the refrigerator near heat or in direct sunlight.
- ▲ Remove the straps securing the cardboard packing  
Remove the cardboard covering  
Remove the PET protection film
- ▲ Clean the refrigerator with mild detergent and then dry it with a soft cloth.

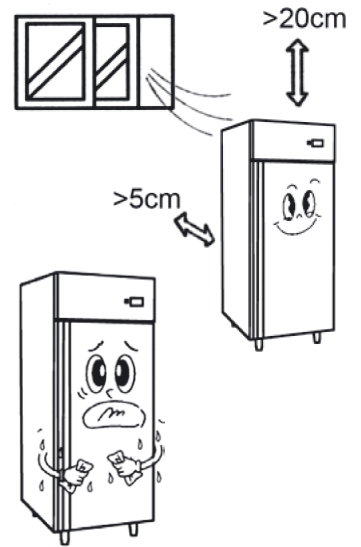

### 8. Connecting to the main power supply

This operation must be carried out by professionally and qualified staff.

The refrigerator is supplied complete with a power supply cable for the connection to the main power supply. A thermomagnetic circuit breaker (not supplied) must be installed between the mains power point and the power supply cable of the refrigerator.

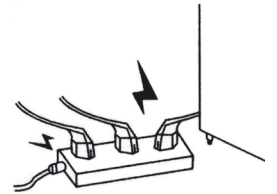

#### Before proceeding make sure that:

- ▲ the mains voltage corresponds to the voltage on the refrigerator 220V/50Hz/1 Ph; to ensure proper operation it is essential for the power supply voltage to come within a 220 range of +/- 10% of the unit's rated voltage.
- ▲ the electric system, is sized to cater for the rated electric output of the refrigeration unit being installed
- ▲ the electronic system to which the refrigerator is connected is made in compliance with current standard requirements
- ▲ the electric connections and the installation of the thermomagnetic circuit breaker have been done by qualified person.

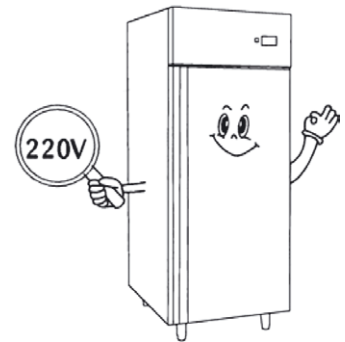

#### Connecting steps:

- ▲ Install a thermomagnetic circuit breaker suited to the rated output of the unit being installed (This should be on the main circuit board)
- ▲ Connect the refrigerator unit to the thermomagnetic circuit breaker outlet
- ▲ Check that the refrigerator is on as demonstrated by the pilot light incorporated in the main switch.



## INSTRUCTION MANUAL SUMMIT SERIES VERTICAL RANGE

### 9. Maintenance instructions

The smooth operation and life of the equipment are mainly determined by correct and regular maintenance

#### Cleaning:

Regular cleaning of the refrigerator unit is strongly recommended each month. Please follow the instructions below.



Disconnect the refrigerator power supply cable from the mains prior to carrying out any type of cleaning operation.

#### Cleaning the refrigerator surface:

Clean the refrigerator with mild detergent and then dry it with a soft cloth.

Do not use abrasive detergents!

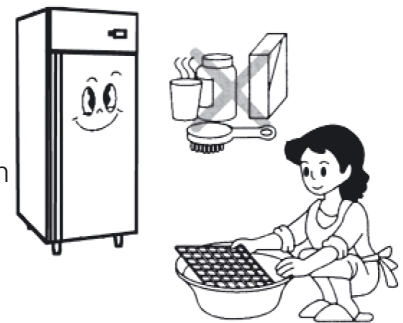

#### Cleaning the inside of the refrigerator

Clean the inside of your refrigerator at least once each month with a detergent suitable for use with foodstuffs.

#### Cleaning the condenser

For efficient operation of the refrigerator it is advisable to clean the condenser regularly approx. every 4 months with a dry brush or vacuum cleaner.

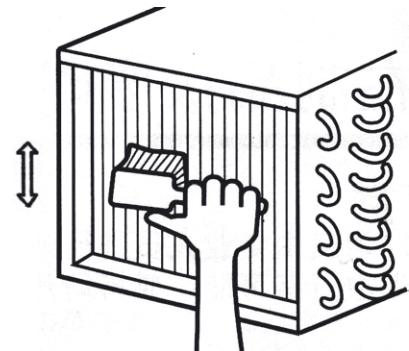

### 10. Troubleshooting

Refrigerator stops working (light off):

- Power supply failure
- ▲ Remedies:
  - Check that the plug is inserted properly in to the socket
  - Check the on/off switch
  - Check that the mains power is running
- ▲ Refrigerator temperature goes up:
  - Unit too near to a heat source
  - Condenser dirty or lacking ventilation
- ▲ Remedies:
  - Move the counter or the heat source further away
  - Clean the condenser, allow more air flow

### 11. Technical service

For technical service please contact the dealer technical department and give him the serial n°, and the date of purchase.



# INSTRUCTION MANUAL SUMMIT SERIES VERTICAL RANGE

## 12. Configuration Sketch Map

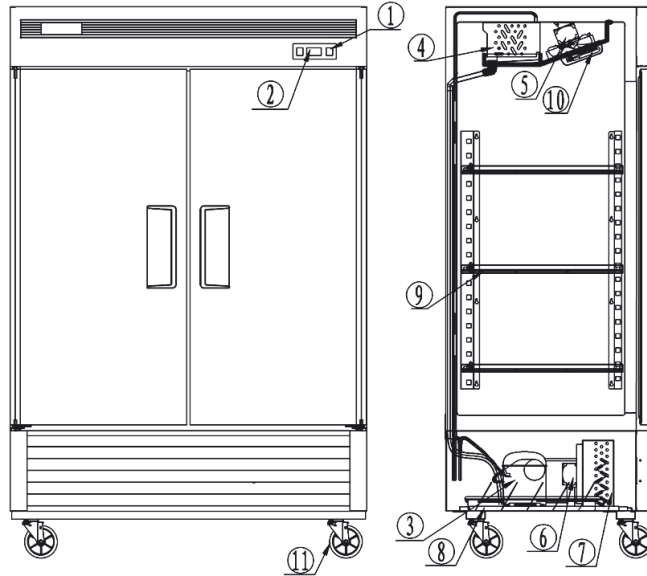

1. Power switch
2. Microcomputer controller
3. Compressor
4. Evaporator
5. Evaporator fan motor
6. Condenser fan motor
7. Condenser
8. Drain case
9. Shelf
10. Lamp
11. Castor

## Operating Instructions

### 1. Display and functions

During normal operation, the controller displays the value of the probe set using parameter '4' (=1 ambient probe, default, =2 second probe, 3= third probe). In addition, the display has LEDs that indicate the activation of the control functions (see Table 1), while the 3 buttons can be used to activate/deactivate some of the functions (see Table 2).



### 2. LEDs and associated functions

| icon | function   | normal operation                                 |  |         | start up         |
|------|------------|--|--|---------|------------------|
|      |            | ON   | OFF  | blink   |                  |
|      | compressor | on   | off  | request | ON               |
|      | fan        | on   | off  | request | ON               |
|      | defrost    | on   | off  | request | ON               |
| AUX  | aux        | output on  | output off   | -       | ON               |
|      | alarm      | all  | no alarm   | -       | ON               |
|      | clock      | RTC fitted and enabled, at least 1 time band set | RTC not fitted or disabled, not even 1 time band set | -       | ON if RTC fitted |

Tab. 1



# INSTRUCTION MANUAL SUMMIT SERIES VERTICAL RANGE



### 3. Table of functions activated by the buttons—models S, X, Y, C

| button |              | normal operation   |  | start up   |  |
|--------|--------------|--|--|--|--|
|        |              | pressing the button alone  | pressed together                             |  |  |
|        | up ON/OFF    | more than 3 s: toggle ON/OFF   | Pressed together start/stop continuous cycle | Pressed together start parameter reset procedure | for 1 s display firmware vers. code<br>for 1 s RESET current EZY set |
|        | down defrost | more than 3 s: start/stop defrost  |  |  |  |
|        | setmute      | - 1 s.: display/set the set point<br>- more than 3 s: access parameter setting menu (enter password '22')<br>- mute audible alarm (buzzer) | -  |  |  |

Tab. 2

### 4. Setting the set point (desired temperature)

- press SET for 1 s, the set value will start flashing after a few moments; increase or decrease the value using UP or DOWN;
- press SET to confirm the new value.

### 5. Switching the device ON/OFF

- Press UP for more than 3 s. The control and defrost algorithms are now disabled and the instrument displays the message “OFF” alternating with the temperature read by the set probe.

### 6. Manual defrost (models S, X, Y and C only)

- Press for DOWN more than 3 s (the defrost starts only the temperature conditions are valid).





## 7. Continuous cycle (models S, X, Y and C only)

→ Press UP and DOWN together for more than 3 s.

## 8. Access and setting type F (frequent) and type C (configuration) parameters

→ press SET for 3 s (the display will show “PS”);

- to access the type F and C parameter menu, enter the password “22” using UP/DOWN;
- to access the F parameter menu only, press SET (without entering the password); scroll inside the parameter menu using UP/DOWN;
- to display/set the values of the parameter displayed, press SET, then UP/DOWN and finally SET to confirm the changes (returning to the parameter menu).

→ To save all the new values and exit the parameter menu, press SET for 3 s;

→ To exit the menu without saving the changed values (exit by timeout) do not press any button for at least 60 s.

## 9. Safety standards

Compliant with the relevant European standards.

Installation precautions: the connection cables must guarantee insulation up to 90°C; for 12 Vac versions use Class II transformers. To ensure compliance with the immunity standards (surge), the transformer must be one of the models specified.

To ensure double insulation between the power connectors and the relay outputs, earth the secondary winding; ensure a space of at least 10mm between the case and the nearby conductive parts; digital and analogue input connections less than 30m away; adopt suitable measures for separating the cables so as to ensure compliance with the immunity standards; Secure the connection cables of the outputs so as to avoid contact with very low voltage parts.



# INSTRUCTION MANUAL SUMMIT SERIES VERTICAL RANGE

Our products have been modified precisely before leaving factory, so to avoid damaging compressor unit or other malfunctions, users must not modify the microcomputer parameters.

## Electrical Control Circuit Diagram

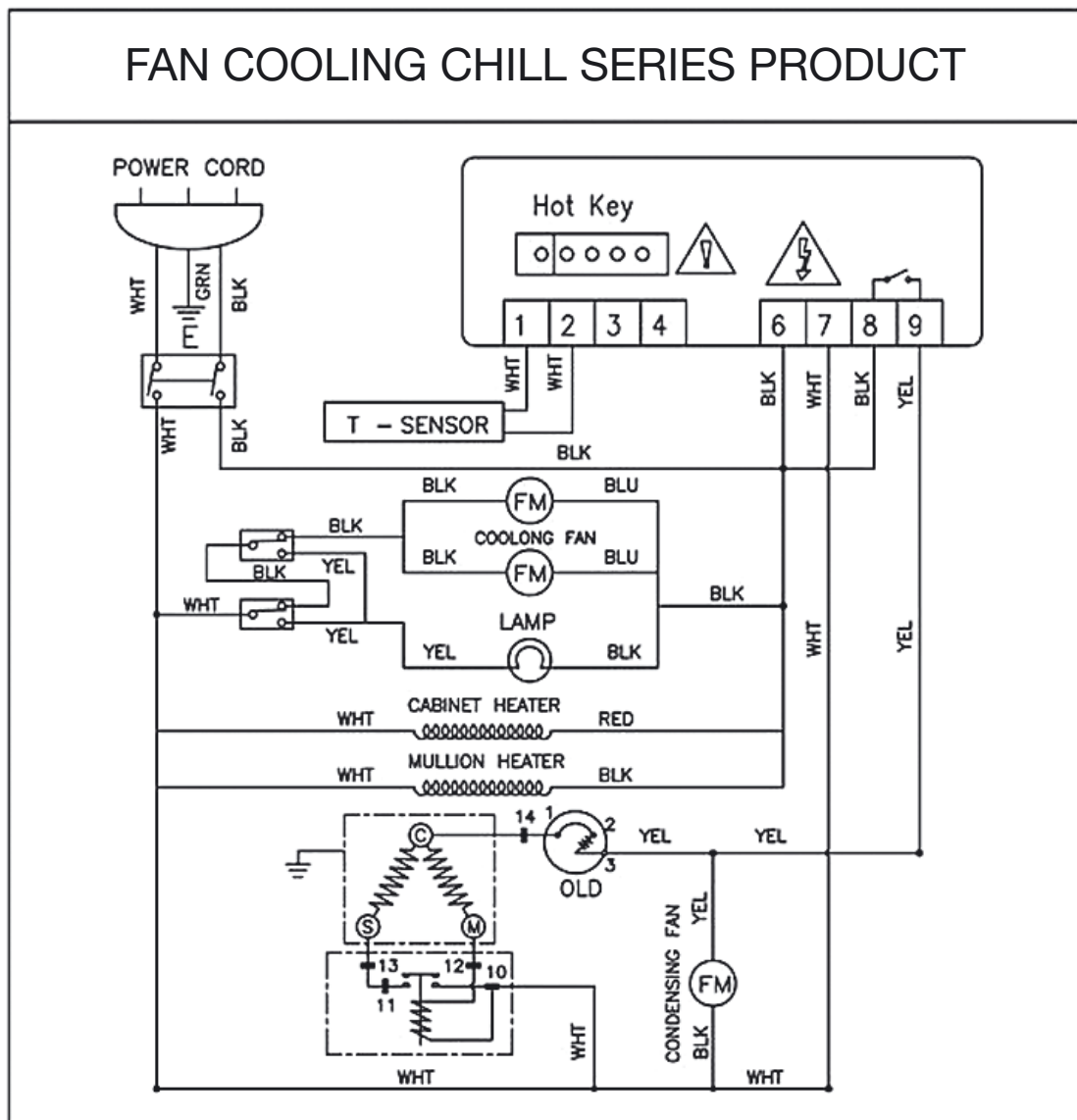



# INSTRUCTION MANUAL SUMMIT SERIES VERTICAL RANGE

## FAN COOLING FREEZE SERIES PRODUCT

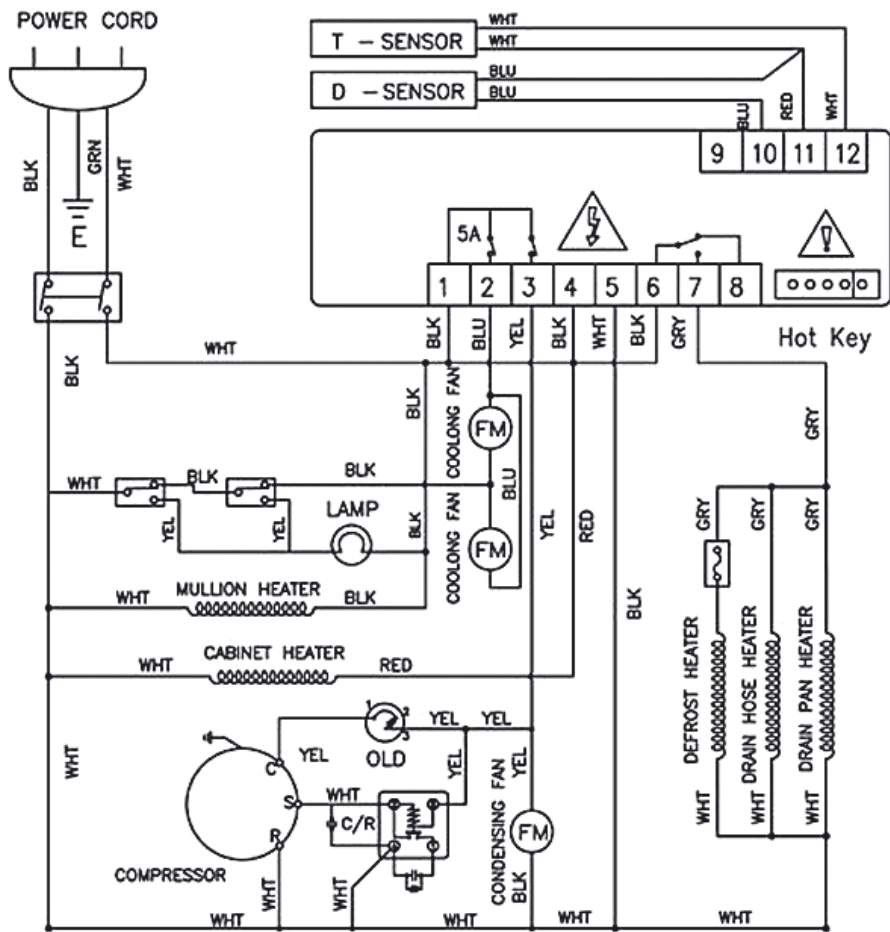



## Technical Parameters

### Summit Series Reach-Ins

| Product Name             | Model Code | Prevention class of getting an electric shock | Power current (V)<br>Rating frequency (Hz) | Rated current (A) | Temperature range (°C) | Refrigerant | Dimension (mm)    | Net Weight (kg) |
|--------------------------|------------|---|--|-------------------|------------------------|-------------|-------------------|-----------------|
| SINGLE DOOR FREEZER      | ERE63      | 1   | 220~240/50                                 | 3                 | -22~-17                | R290        | 685 x 800 x 2135  | 120             |
| TWO DOOR FREEZER         | ERE64      | 1   | 220~240/50                                 | 4                 | -22~-17                | R290        | 1382 x 800 x 2135 | 190             |
| SINGLE DOOR REFRIGERATOR | ERE65      | 1   | 220~240/50                                 | 2.3               | +1~+8                  | R600a       | 685 x 800 x 2135  | 115             |
| TWO DOOR REFRIGERATOR    | ERE66      | 1   | 220~240/50                                 | 2.8               | +1~+8                  | R600a       | 1382 x 800 x 2135 | 180             |

Technical details subject to change without notification.

## Official Approval and Rules

Our products full fill the present E.U. rules, including the CE mark of the European official approval

89/336/EEC including amendments-electromagnetic compatibility (EMC)

73/23/EEC including amendments-low voltage (LVD)

EN 60335-1:2005

EN 60335-2-24:2004

EN 55014-1:2003

EN 55014-2:2002

EN 61000-3-2:2001

EN 6100-3-3:2002

Serial No. C003-106-076

@20110906





## INSTRUCTION MANUAL SUMMIT SERIES VERTICAL RANGE

### **Southern Hospitality—EuroChill Warranty Document**

*This Document covers Summit and Compact ranges*

EuroChill Refrigeration products offer a 2 year Warranty on the Summit range of chillers and freezers.

#### **Warranty:**

This warranty is for parts and labour for a period of:

- 24 months from the date of invoice for the Summit and Compact range.

This warranty is for normal hours of work, 7:30–5:00 Monday to Friday, except on public holidays.

#### **Warranty Procedure:**

To report a problem with your cabinet, please contact the Service and Spares Division on:

- 0800 504 504 for New Zealand/Pacific Islands

Please have serial number, invoice and date of purchase information as well as a description of the fault.

#### **On receiving your cabinet:**

1. Check the packaging for damage.
2. Remove item from packaging material and then check again for damage. If damaged, contact your supplier immediately
3. Check that you have received the correct model cabinet (refer to the serial number plate for model number) The serial number will be reflected on your invoice.
4. Cabinet to be leveled and stabilized on the floor when in final position. Try to avoid direct sunlight and excessive heat from other kitchen equipment
5. Ensure there is sufficient ventilation.
6. Position shelving.
7. Check that the power supply matches that of the cabinet. This will be shown on the serial plate of the cabinet
8. Allow the cabinet to remain standing, unplugged for 30 minutes.
9. Check that there are no obstructions and that nothing is blocking the fans or motors that may prevent them from safe operation.
10. Keep All air vents and ducts clear
11. Turn the power on
12. Check the controller is set to the correct temperature setting. +2°C for chiller and -18 ~ -20°C for freezers
13. Allow the system to operate for 24 hours before loading with product. The system would have then reached the set temperature and also cycled more than once. This ensures that there was no internal fault due to transport. If you load the unit earlier. Close monitoring is required for the first 24 hours of operation.



## INSTRUCTION MANUAL SUMMIT SERIES VERTICAL RANGE

### **Basic Operation:**

1. The standard refrigeration cabinets with either drawer or doors are designed to operate with these closed.
2. Please ensure your staff simply open and remove product and then close the doors immediately
3. Please ensure that enough space is left in the cabinet to allow sufficient circulation of air. Do not overload unit.

### **Basic Maintenance:**

1. We require cleaning of the condenser (external radiator) at least once every 3 months with a dry brush and/or vacuum cleaner. Initially we recommend you clean this month to get an idea of the dust levels in your environment.
2. Every self contained refrigeration unit has a drain from the internal evaporator coil to a dissipater tray. The condensate water is then evaporated away. These drains require cleaning at regular intervals. The first indication of a blocked drain is water at the bottom of your cabinet.
3. The units needs to be fully emptied and cleaned out once every two weeks.

*This Warranty is subject to the following terms and conditions:*

### **Conditions:**

1. All refrigeration items must be installed correctly. Adequate ventilation must be supplied as per manufacturer specifications.
2. Subject to basic and regular service maintenance—Regular maintenance is required a minimum of every 6 months by a qualified technician. There is a record document at the back of the Instruction manual, for your convenience, to keep track of this information. If regular maintenance does not take place this may void warranty. The cost of this maintenance is not covered by Southern Hospitality.

### **1. Does not cover**

- a. Damage by misuse or abuse—Any fault or component failure caused by lack of maintenance will be charged to owner/operator of the equipment.
  - b. Second hand equipment unless specified in writing by Southern Hospitality
  - c. Glass, light bulbs, flour tubes or any other consumables.
  - d. Damage to goods arising from circumstances beyond the manufacturers control and/or natural disaster; include but not limited to power surges, disruption to service.
  - e. Faults due to customer design or specification.
  - f. Modification of units
2. Any replacement or repaired goods will only be warranted for the remaining time of the warranty of the original purchase/invoice date.
  3. Any repairs must be undertaken by an approved refrigeration engineer.

***Failure to comply with these conditions will void the warranty.***

***All units must be installed as per the manufacturers specification and have adequate ventilation at all times.***