

PLAN

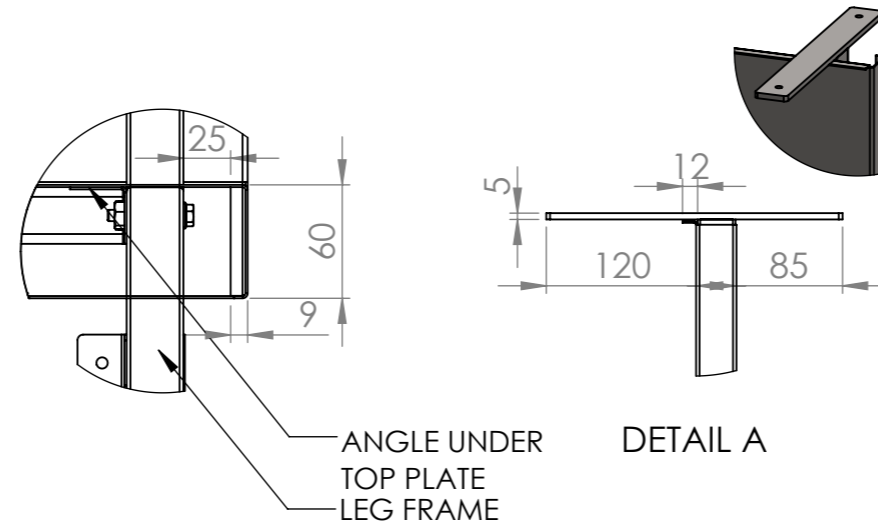

DETAIL B

DETAIL A

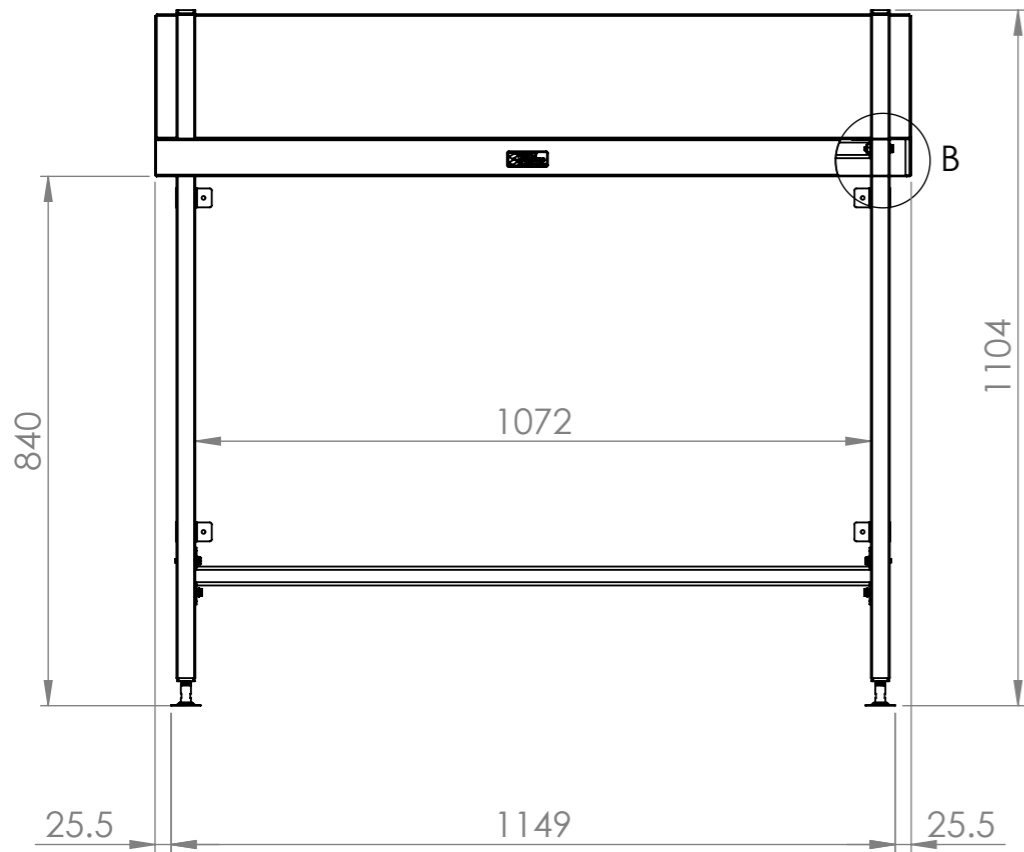

FRONT ELEVATION

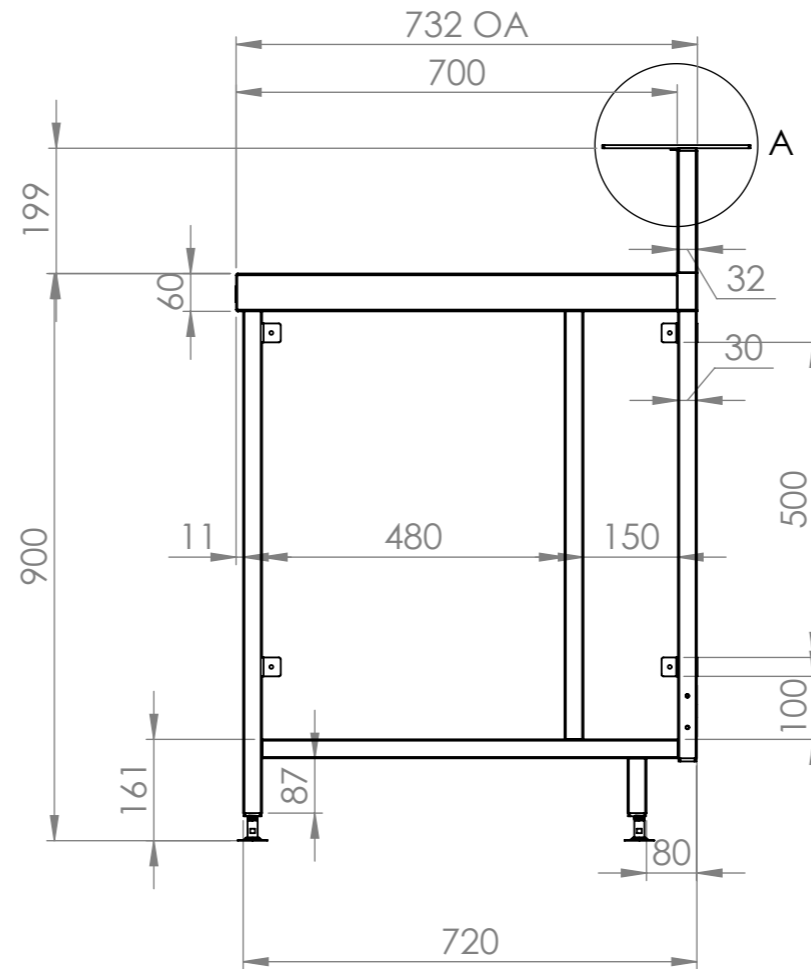

SIDE ELEVATION



Modular Bar Solutions

COPYRIGHT © 2022

This drawing is the property of CI GROUP PTY LTD. Tradings as SIMPLY BARS and It may not be copied, reproduced or modified in whole or in part without prior written permission of CI GROUP PTY LTD. SIMPLY BARS reserves the right to change specification and design without notice.

**SBM-7-1200
BAR MODULE 1200mm**

SIZE: A3

SCALE : 1:10

CONSTRUCTION NOTES :

1. TOPS MADE FROM 304 GRADE, 1.2mm STAINLESS STEEL.
2. LEG FRAME MADE FROM 30mm STAINLESS STEEL SQ TUBE.
3. FEET ARE ADJUSTABLE STAINLESS STEEL DISC SHAPED FEET.

SBM-7-1200