



## Benchtop Cold Curved Display Cabinet

### OPERATION INSTRUCTIONS



**ERD89**



**ERD90**

• Specifications are subject to change without notice. Subject to correct use and maintenance.

Delta Manufacturing  
Distributed by Southern Hospitality Ltd  
0800 503 335  
[www.southernhospitality.co.nz](http://www.southernhospitality.co.nz)

southern  
hospitality



Thank you for choosing and purchasing our products. Please carefully read the operating instructions before use, for correct application and satisfactory results.

## Contents

- General
- Structure and Parts
- Handling
- Preparation and Power Supply
- Use and Caution
- Maintenance
- Trouble Shooting
- Principle of Refrigeration System and Electric Circuit Diagram
- Major Parameters

• Specifications are subject to change without notice. Subject to correct use and maintenance.

Delta Manufacturing  
Distributed by Southern Hospitality Ltd  
0800 503 335  
[www.southernhospitality.co.nz](http://www.southernhospitality.co.nz)

southern  
hospitality



### General

1. Top brand fully enclosed compressor is used on the standing refrigerator. The refrigerant R600a is an environmentally friendly agent. It features a rational configuration of refrigeration system with blower forced air cooling for even temperature throughout.
2. Double hollow transparent glass is used on door and body. It features an elegant design, perfect view and easy access.
3. It has a wide application in cafes, bakeries and restaurants.

### Overview of parts

Installation advice:



• Specifications are subject to change without notice. Subject to correct use and maintenance.

Delta Manufacturing  
Distributed by Southern Hospitality Ltd  
0800 503 335  
[www.southernhospitality.co.nz](http://www.southernhospitality.co.nz)

southern  
hospitality



## Handling

### Handle with care

Unplug the wall socket first.  
Never tilt it over 45 degree during handling.

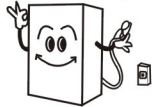

### Dry place

Always locate the refrigerator at a dry place.



### Sufficient space

The distance from both sides and back of refrigerator to wall or other surface must not less than 10 cm.  
The refrigeration capability might be decreased if its surrounding space is too small to circulate air.

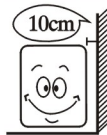

### Ventilation

Always locate the refrigerator at a place with good ventilation. For the first time use, wait for 2 hours after handling and then plug the wall socket and start it.

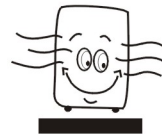

### Heat sources

Never place the refrigerator directly in sunlight. Never locate it near any heat source or heater to prevent it from reducing refrigeration capability.



### No heavy load

Never put any heavy load on the top of the refrigerator.



### Piercing

Never make holes in the refrigerator. Never install other items on top of the refrigerator.



### Stable location

Always locate the refrigerator on a flat and solid surface.



• Specifications are subject to change without notice. Subject to correct use and maintenance.



### Preparation and power supply

#### Exclusive power socket

Normally, the power supply should be 220-240V, single phase AC with exclusive single phase three pin receptacle (250V 10A) and fuse (6A). The power receptacle must have a reliable earth connection.



#### No share on socket

Never let the refrigerator share the common socket with other appliance, other wise the cable will overheat and might cause fire.

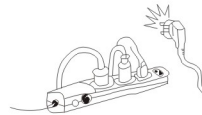

#### Protect cables

Never break or damage the cables otherwise current leakage and fire might result.

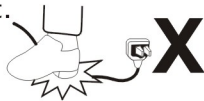

#### No water

Do not use a hose on the refrigerator, this will cause electrical fault.



#### Prevent from flammables and explosive

Never put any flammable or explosives inside the refrigerator such as ether, gasoline, alcohol, adhesive and explosive. Never put dangerous product near the refrigerator.



#### No spray

To spray the flammables such as paint or coating nearby the refrigerator is not allowed, otherwise fire might result.

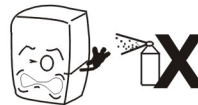

#### After power cuts

After power break or unplugging the refrigerator, always wait at least 5 minutes before starting again.



#### No medicine

No medicine is allowed to be kept inside the refrigerator.



• Specifications are subject to change without notice. Subject to correct use and maintenance.



## Use and Caution

### 1. Before use

Plug the refrigerator into 220-240V~ exclusive socket.

Once the refrigerator is running, check air suction to confirm it is sufficiently cold.

Then you may put food inside the cabinet.

### 2. Digital temperature controller

Refrigerant LED    Defrost LED

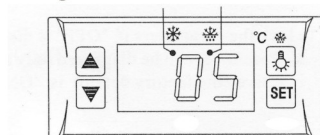

It is a mini-sized and integrated intelligent controller and applicable to the compressor of one Hp.

The main functions are: Temperature Display/Temperature Control/Manual, automatic defrost by burning off/Illumination Control/Value Storing/Self Testing/Parameter Locking

### Front Panel Operation

#### 1. Set temperature

Press **SET** button, the set temperature is displayed.

Press **▲** or **▼** button to modify and store the displayed value,

Press **SET** button to exit the adjustment and display the cold-room temperature.

#### 2. If no more button is pressed within 10 seconds, the cold-room temperature will be displayed.

#### 3. Illumination: Press **☀** button, it lights; Press again, it stops.

Manual start/stop defrost: Press **☀** button and hold for 6 seconds to defrost or stop defrost.

#### 4. Refrigerant LED: During refrigeration, the LED is on; When the cold room temp. is constant, the LED is off; During the delay start, the LED flashes.

#### 5. Defrost LED: During defrosting, the LED is on; When it stops defrosting, the LED is off; During the delay display of defrost, the LED flashes.

• Specifications are subject to change without notice. Subject to correct use and maintenance.



### 3. General Advice:

Shorten the door opening time and reduce open frequency to keep a cold temperature inside the refrigerator.

Never block the air suction and outlet. Keep air circulation and refrigeration capability.

Do not overfill as it will influence the cooling effect.

Adjust the rack height for proper food storage.

Cool hot food down to room temperature before you put it into the refrigerator.

Reduce the open times and keep refrigerator inside cold in case the power is cut off.

Never touch compressor to avoid burning.

If the supply cord is damaged, it must be replaced by the manufacturer, its service agent or similarly qualified persons in order to avoid a hazard.

This appliance is not intended for use by persons (including children) with reduced physical, sensory or mental capabilities, or lack of experience and knowledge, unless they have been given supervision or instruction concerning use of the appliance by a person responsible for their safety.

Children should be supervised to ensure that they do not play with the appliance.

**WARNING:** Keep ventilation openings, in the appliance enclosure or in the built-in structure, clear of obstruction.

**WARNING:** Do not use mechanical devices or other means to accelerate the defrosting process, other than those recommended by the manufacturer.

**WARNING:** Do not damage the refrigeration circuit.

**WARNING:** Do not use electrical appliances inside the food storage compartments of the appliance, unless they are of the type recommended by the manufacturer.

### ADDITIONAL WARNING

Caution: Risk of fire. The height of the triangle in the symbol shall be at least 15mm.



• Specifications are subject to change without notice. Subject to correct use and maintenance.

Delta Manufacturing  
Distributed by Southern Hospitality Ltd  
0800 503 335  
[www.southernhospitality.co.nz](http://www.southernhospitality.co.nz)

southern  
hospitality



### Maintenance

**1. Notice**

Keep the refrigerator clean and periodical maintenance (6 monthly) is necessary. Always unplug the socket before maintenance

Never use damaged plug or loose socket to prevent from electric shock or short circuit.

Never flush the refrigerator. Never use alkali detergent, soap, gasoline, acetone or brush.

**2. Clean outside**

Dip soft cloth in neutral detergent (table ware detergent) to clean the outside of the refrigerator and then wipe it with dry soft cloth.

**3. Clean inside**

Take rack out for cleaning with water

Use soft cloth to wipe the box.

**4. When shutting down refrigerator for a long time**

Take all food out and unplug the wall socket.

Clean both inside and outside of the refrigerator thoroughly and open the door for sufficient dry.

The glass breaks easily. Keep the glass far from children.

**5. Replacement of lamp in the light box**

If the LED is damaged, it must be replaced by the manufacturer or its service agent.

### Trouble Shooting

Trouble	Cause and Remedy
No refrigeration	Is the plug in socket well? Is the fuse broken? Is there no power?
Unsatisfactory	Is it in the sun? Is there any heat source nearby? Is the surrounding ventilation bad? Does the door seal strip deformed or damaged? Is food congested or cabinet overfull? Does food block the air suction or outlet? Regulate the temperature controller.
Too much noise	The refrigerator is not level. The refrigerator contacts wall or other surfaces. There is loose part in refrigerator.
Contact local service agent for help if simple trouble shooting does not solve the problems	

• Specifications are subject to change without notice. Subject to correct use and maintenance.





**Note:**

**Following phenomena are not trouble:**

The murmur of water is heard when the refrigerator is working. It is a normal phenomenon as the coolant is circulating in the system.

In wet season, condensation might be found on the outside of the refrigerator. It is not a trouble, which is caused by high humidity. Simply use cloth to wipe it.

**Principle of refrigeration system**

The principle of compression refrigeration consists of ? “Compression” , “condensation” , “throttling” and “vaporization” .The compression is undertaken by compressor, the condensation is completed by condenser, the throttling is executed by capillary and the vaporization is implemented by evaporator. When the coolant is circulating in the closed refrigeration system, the compressor sucks coolant, which has absorbs heat in evaporator, the coolant becomes a high pressure and high temperature gas. In condenser, it dissipates heat in air, while the coolant is re-liquefied and throttled in capillary and then enters into evaporator with low pressure; the liquefied coolant quickly boils and vaporizes into gas when the pressure suddenly drops. Meanwhile, it absorbs heat inside the refrigerator. And he compressor sucks the low pressure and low temperature gaseous coolant..... It is circulating in this way up to realization of intended refrigeration.

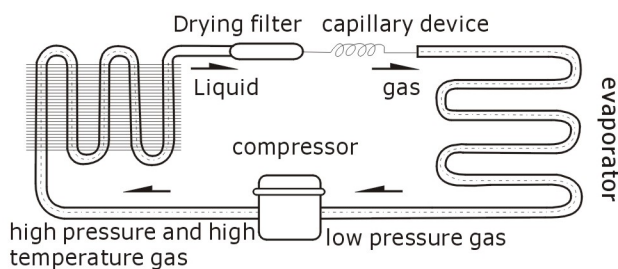

• Specifications are subject to change without notice. Subject to correct use and maintenance.



### Circuit Diagram

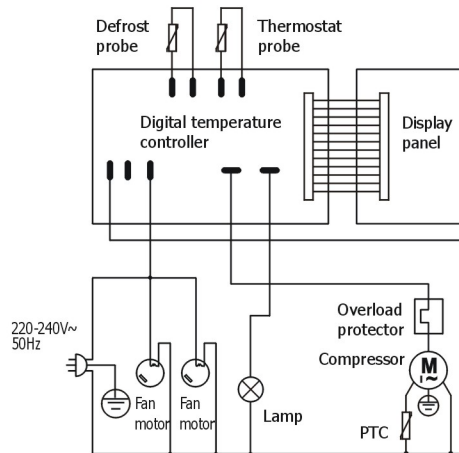

### Major Parameters

Model:	RTW-120B	RTW-160B
Rated Input Power(W):	160	160
Refrigeration Temperature(°C)	0-12	0-12
Rated Frequency(Hz):	50	50
Rated Current(A):	1.2	1.2
Refrigerant&Injection(g):	R600a(50)	R600a(65)
Type of Climate:	N	N
Protected Mode:	I	I
Lamp Power(W):	2(LED)	2.5(LED)
Rated Voltage(V):	220-240~	220-240~
Storage Volume(L):	120	160
Net Weight(kg):	57	66
Overall Dimension(mm)(LxWxH):	702x568x686	880x568x686
Power Consumption(KW.h/24h):	4.2	4.2

• Specifications are subject to change without notice. Subject to correct use and maintenance.



### Note

1. The electric circuit diagram and parameters on the product name plate are final ones if they have been changed.
2. The design might be improved without notice.



### Meaning of crossed out wheeled dustbin:

Do not dispose of electrical appliances as unsorted municipal waste, use separate collection facilities.

Contact you local government for information regarding the collection systems available.

If electrical appliances are disposed of in landfills or dumps, hazardous substances can leak into the groundwater and get into the food chain, damaging your health and well-being. When replacing old appliances with new ones, the retailer is legally obligated to take back your old appliance for disposals at least free of charge.

• Specifications are subject to change without notice. Subject to correct use and maintenance.

Delta Manufacturing  
Distributed by Southern Hospitality Ltd  
0800 503 335  
[www.southernhospitality.co.nz](http://www.southernhospitality.co.nz)

southern  
hospitality