

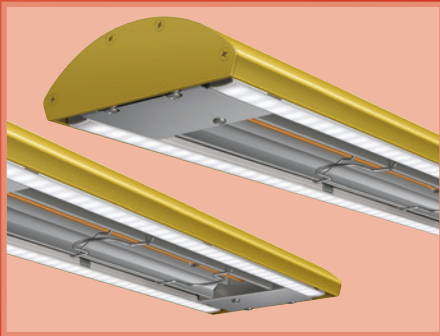

Strip Heater Solutions

*Cafeterias • Buffets • Supermarkets & Delis
Restaurants & Cafés • Clubs & Bars*



GR5AL-24 shown in optional Gleaming Gold Gloss finish *pg. 5*



GRAL-48 *pg. 7*



GRAH-42D with optional 6" spacer and optional non-adjustable tubular stands *pg. 9*



GRAML-60D with optional non-adjustable tubular stands *pg. 15*



GRNH-48 with Standard angle brackets and optional *Designer* color (sneeze guards as shown not available) *pg. 19*



GRAIHL-48, requires Remote Control Enclosure (RMB) *pg. 21*



GR2AHL-84 with optional *Designer* color housing and sneeze guards *pg. 25*



UGA-24D in optional Radiant Red Gloss finish *pg. 30*



UGAH-36D with Standard 3" spacer *pg. 30*



Ordering Instructions



GR5AL or GR5AHL



GR5A or GR5AH

Glo-Ray® Curved Infrared Strip Heaters: *(pages 4-5)*

1. Choose a length
2. Standard or high watt
3. Lights or no lights
4. Voltage: 120, 208, 240
5. Choose control option for GR5A and GR5AH (GR5AL, GR5AHL have Remote Control Box included)



GRA-72, GRAH-72 or GRAM-72

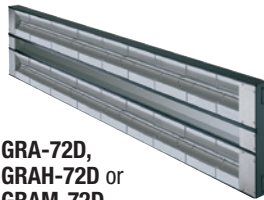

GRA-72D, GRAH-72D or GRAM-72D



GRAL-72, GRAHL-72 or GRAML-72



GRAL-72D, GRAHL-72D or GRAML-72D

Glo-Ray® Infrared Metal-Sheathed Strip Heaters: *(pages 6-16)*

1. Choose a length
2. Single or dual warmer
3. Standard, high or max watt
4. Lights or no lights
5. Voltage: 120, 208, 240 without lights or 120, 240, 120/208, 120/240 for units with lights
6. Choose control option, remote installation recommended (required on some models)*

GR-36 or GRH-36

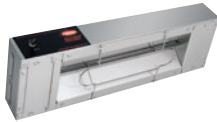

Glo-Ray® Infrared Stainless Steel Strip Heaters: *(pages 7-8)*

1. Choose a length
2. Standard or high watt
3. Voltage: 120, 208 or 240
4. Choose control option, remote installation is recommended*

GRN4L-36



GRN4-36

Glo-Ray® Narrow Halogen Strip Heaters: *(page 17-18)*

1. Choose a length
2. Voltage: 120
3. Includes Remote Control Enclosure

GRN-24, GRNH-24 or GRNM-24



Glo-Ray® Narrow Infrared Strip Heaters: *(page 19-20)*

1. Choose a length
2. Standard, high or max watt
3. Voltage: 120, 208, 240
4. Choose control option, remote installation is recommended*

* Multiple Strip Heaters may be connected to one RMB2 if the combined Amp draw of the warmers are less than the rating for the RMB2.

Ordering Instructions
continued

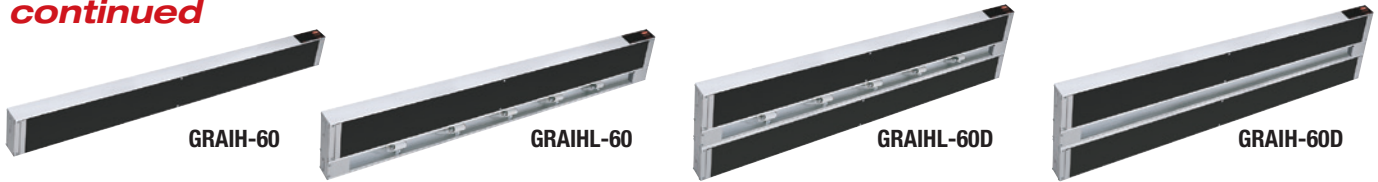

Glo-Ray® Infra-Black® Strip Heaters: (pages 21-23)

1. Choose a length
2. Single or dual warmer
3. Lights or no lights
4. Voltage: 120, 208, 240 without lights or 120/208, 120/240 for units with lights
5. Choose control option, remote installation is recommended*



Glo-Ray® Designer Infrared Strip Heaters: (pages 24-28)

1. Choose a length
2. Single or dual warmer
3. Standard or high watt
4. Lights or no lights
5. Voltage: 120, 208, 240 without lights or 120/208, 120/240 for units with lights
6. Choose control option, remote installation only*
7. Choose inset panel and corner cap color
8. Select Non-adjustable Stand Length or Optional Overhead Mount (shown)

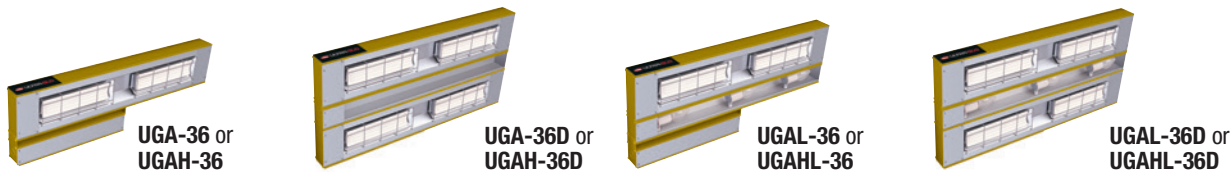

Ultra-Glo® Ceramic Strip Heaters: (pages 29-31)

1. Choose a length
2. Single or dual warmer
3. Standard or high watt
4. Lights or no lights
5. Voltage: 120, 208, 240 without lights or 120/208, 120/240 for units with lights
6. Choose control option, remote installation is recommended*

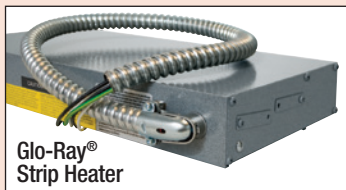

Typical Conduit Connection

Glo-Ray® Strip Heaters come Standard with right angle attached 3' conduit and 42" leads on back of unit.
Narrow Strip Heaters have Standard 6" leads, no conduit.
 GR2A models conduit exits non-adjustable stand or overhead mount only.
 GR5AL models have a 5' leadwire, which is 2' past the 3' conduit.
 Ultra Glo® models conduit exits through attached control box, if no control box, they exit side of unit.

* Multiple Strip Heaters may be connected to one RMB2 if the combined Amp draw of the warmers are less than the rating for the RMB2.



Glo-Ray® Curved Infrared Strip Heaters

This stylish patented design, based on our signature Glo-Ray® Strip Heaters, is the perfect solution for your front-of-the-house applications. Superb for buffet and serving lines, the sleek curved design minimizes its size while accenting and warming the products below.

The entire holding surface is heated evenly with no “cold” spots thanks to Hatco's dependable infrared element technology.

- Narrow, curved design: 2"H x 6"D uses a very small footprint
- Lengths available from 18"-72" in 6" increments
- Patented housing design
- Angle brackets (mounting) are Standard

- Pre-focused heat maintains safe serving temperatures longer without continuing to cook the food
- Available in Standard or high watt
- End panels and mounting brackets match unit color
- Hatco's wide array of colors help provide the right look for your venue

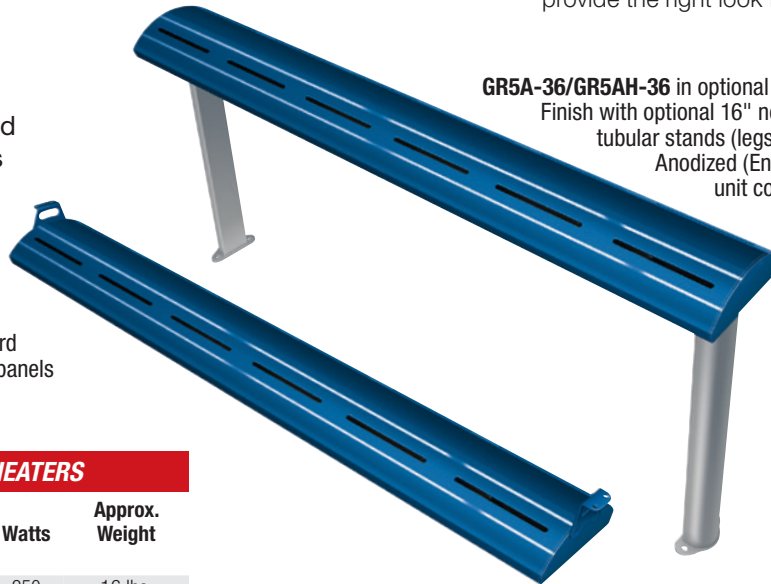

GR5A-36/GR5AH-36 in optional Brilliant Blue Gloss Finish with Standard angle brackets and end panels that match unit color

GR5A-36/GR5AH-36 in optional Brilliant Blue Gloss Finish with optional 16" non-adjustable tubular stands (legs) in Standard Clear Anodized (End panels that match unit color are Standard)

GLO-RAY® CURVED INFRARED STRIP HEATERS

Model ^o	Width	Voltage Single Phase	Watts	Approx. Weight
Standard Watt				
GR5A-18	18"	120, 208 or 240	250	16 lbs.
GR5A-24	24"	120, 208 or 240	350	17 lbs.
GR5A-30	30"	120, 208 or 240	450	19 lbs.
GR5A-36	36"	120, 208 or 240	575	21 lbs.
GR5A-42	42"	120, 208 or 240	675	22 lbs.
GR5A-48	48"	120, 208 or 240	800	24 lbs.
GR5A-54	54"	120, 208 or 240	925	26 lbs.
GR5A-60	60"	120, 208 or 240	1050	28 lbs.
GR5A-66	66"	120, 208 or 240	1160	32 lbs.
GR5A-72	72"	120, 208 or 240	1275	33 lbs.
High Watt				
GR5AH-18	18"	120, 208 or 240	350	16 lbs.
GR5AH-24	24"	120, 208 or 240	500	17 lbs.
GR5AH-30	30"	120, 208 or 240	660	19 lbs.
GR5AH-36	36"	120, 208 or 240	800	21 lbs.
GR5AH-42	42"	120, 208 or 240	950	22 lbs.
GR5AH-48	48"	120, 208 or 240	1100	24 lbs.
GR5AH-54	54"	120, 208 or 240	1250	26 lbs.
GR5AH-60	60"	120, 208 or 240	1400	28 lbs.
GR5AH-66*	66"	120, 208 or 240	1560	32 lbs.
GR5AH-72*	72"	120, 208 or 240	1725	33 lbs.

^o Does not include Remote Control Box (RMB), see pages 34 and 35.
 * Infinite switch not available on 120V.

All Models Feature:

Leads: 3' conduit, 5' Power Leads.

Angle Brackets: Provides 1" clearance between Strip Heater and overshef.

Dimensions: 18"-72"W x 6"D x 2"H.

RECOMMENDED MOUNTING HEIGHTS – PAGE 32 COLORS AND FINISHES – PAGE 36

OPTIONS (available at time of purchase only)

Designer colors – Clear Anodized Standard – End panels and Angle Brackets match unit color – Non-Standard colors are non-returnable –

RED	Warm Red	BLACK	Black
GRAY	Gray Granite	WHITE	White Granite
BLUE	Navy Blue	GREEN	Hunter Green
COPPER	Antique Copper		

Gloss finishes – End panels and Angle Brackets match unit color – Non-Standard colors are non-returnable –

GGOLD	Gleaming Gold	RRED	Radiant Red
GGRAY	Glossy Gray	BBLUE	Brilliant Blue
BBLACK	Bold Black		

NO CONTROL No control included, requires selection of RMB2-xx control – see page 34

REM INF Remote Infinite Switches in lieu of Toggle (max. 12.2 Amps)

REM TOG Remote Toggle Switches (max. 15 Amps)

RMB Remote Box (available in Designer colors or Gloss finishes)

Non-Standard colors are non-returnable – see pages 34 and 35

Non-Adjustable Tubular Stands – Clear Anodized Standard – Available in Designer color or Gloss finish – Non-Standard colors are non-returnable –

NTL5-10, -12 Specify 10" or 12" clearance

NTL5-14, -16 Specify 14" or 16" clearance

NTL5-PAINT Designer color or Gloss finish for

Non-Adjustable Tubular Stands –

Non-Standard colors are non-returnable –

Power Wire Leads – 5' Power Lead length Standard –

GR5A-LEADS10 6'-10' total Power Lead length

GR5A-LEADS15 11'-15' total Power Lead length

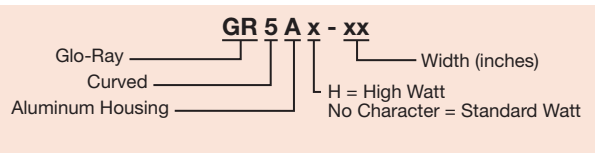

Glo-Ray® Curved Infrared Strip Heaters with LED Lights

Hatco's Glo-Ray® Curved Infrared Strip Heaters with LED Lights feature a patented housing design that is low-profile, elliptical-shaped and stylish, the ideal solution for front-of-the-house applications where heat and/or lights are needed.

It can operate with just the dual LED lights; or the dual LED lights can be used simultaneously with the infrared emitter to provide the perfect balance of light and heat.



- Narrow, curved design: 2"H x 6"D uses a very small footprint with lengths available from 18"-72" in 6" increments
- Patented housing design has energy efficient dual LED lights across the entire strip heater, which provide longer performance and energy savings (compared to Standard incandescent bulbs - 3.5 to 15.2 watts based on length)
- Angle brackets (mounting) are Standard
- Pre-focused heat maintains safe serving temperatures longer without continuing to cook the food
- Can be used with lights only or heat only
- 100% linear infinite controls with adjustability from 0-100%, allow for precise settings
- Field replaceable LED available as:
 - Warm White* (Standard)
 - Neutral (Cool) White*
 - Dual Color: Warm White/Neutral (Cool) White* (toggle between color temperatures to enhance foods displayed)
- Electronic infinite control Remote Box and power On/Off switch (controls lights, heat) included
- Available as lights only (see HL5 series in Decorative Lamps & Display Lights section)

GR5AL-36/GR5AHL-36 Top and bottom view. Shown in optional Radiant Red with LED lights, and standard Angle Brackets (End panels and angle brackets that match unit color are Standard)

CURVED INFRARED STRIP HEATERS WITH LED LIGHTS

Model	Width	Voltage Single Phase	Watts	Approx. Weight
Standard Watt				
GR5AL-18	18"	120, 208 or 240	254	16 lbs.
GR5AL-24	24"	120, 208 or 240	356	17 lbs.
GR5AL-30	30"	120, 208 or 240	458	19 lbs.
GR5AL-36	36"	120, 208 or 240	584	21 lbs.
GR5AL-42	42"	120, 208 or 240	686	22 lbs.
GR5AL-48	48"	120, 208 or 240	812	24 lbs.
GR5AL-54	54"	120, 208 or 240	939	26 lbs.
GR5AL-60	60"	120, 208 or 240	1066	28 lbs.
GR5AL-66	66"	120, 208 or 240	1177	32 lbs.
GR5AL-72	72"	120, 208 or 240	1294	33 lbs.
High Watt				
GR5AHL-18	18"	120, 208 or 240	354	16 lbs.
GR5AHL-24	24"	120, 208 or 240	506	17 lbs.
GR5AHL-30	30"	120, 208 or 240	668	19 lbs.
GR5AHL-36	36"	120, 208 or 240	809	21 lbs.
GR5AHL-42	42"	120, 208 or 240	961	22 lbs.
GR5AHL-48	48"	120, 208 or 240	1112	24 lbs.
GR5AHL-54	54"	120, 208 or 240	1264	26 lbs.
GR5AHL-60	60"	120, 208 or 240	1416	28 lbs.
GR5AHL-66	66"	120, 208 or 240	1577	32 lbs.
GR5AHL-72	72"	120, 208 or 240	1744	33 lbs.

All Models Feature:

Switch Location: Remote box with electronic infinite control and power On/Off switch (controls lights and heat) included.

Leads: 3' conduit, 5' Power Leads, 6½' (78") LED Leads.

Standard LED lead length is 1½' (18") longer than Power Lead length.

Angle Brackets: Provides 1" clearance between strip heater and overshef.

Dimensions: 18"-72"W x 6"D x 2"H.

Control Box Dimensions: 11"W x 5½"H. **Cut Out Dim.:** 10⅞"W x 6¼"D x 4¾"H.

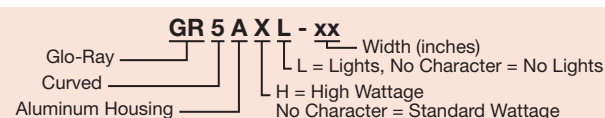

OPTIONS (available at time of purchase only)

Designer colors – Clear Anodized Standard – End panels and Angle Brackets match unit color – Non-Standard colors are non-returnable –

RED	Warm Red	BLACK	Black	GRAY	Gray Granite
WHITE	White Granite	BLUE	Navy Blue	GREEN	Hunter Green
COPPER	Antique Copper				

Gloss finishes – End panels and Angle Brackets match unit color – Non-Standard colors are non-returnable –

GGOLD	Gleaming Gold	RRED	Radiant Red	GGRAY	Glossy Gray
BBLUE	Brilliant Blue	BBLACK	Bold Black		

Non-Adjustable Tubular Stands – Clear Anodized Standard – Available in Designer color or Gloss finish – Non-Standard colors are non-returnable –

NTL5-10, -12	Specify 10" or 12" clearance
NTL5-14, -16	Specify 14" or 16" clearance
NTL5-PAINT	Designer color or Gloss finish for Non-Adjustable Tubular Stands – Non-Standard colors are non-returnable –

GR5AL-NW	Neutral (Cool) White LED*
GR5AL-WW/NW	Dual Warm/Neutral (Cool) White LED*
GR5AL-OPP	Power and LED wiring exit opposite ends of unit (Same end is the Standard offering) – Must specify Power Lead length and LED Lead length required

Power Wire Leads – 5' Power Lead length is Standard –

GR5AL-LEADS10	6'-10' total power Lead length
GR5AL-LEADS15	11'-15' total power Lead length
LED Leads - 6½' (78") LED Lead length is Standard – (Standard LED lead length is 1½' (18") longer than Power Lead length)	
LED-LEADS10	11½' (138") total LED Lead length
LED-LEADS15	16½' (198") total LED Lead length
LED-LEADS20	21½' (258") total LED Lead length

RECOMMENDED MOUNTING HEIGHTS – PAGE 32
COLORS AND FINISHES – PAGE 36

RECOMMENDED LIGHT USAGE

GR5A(H)L above...	Warm White*	Cool White*	Warm/Neutral (Cool) White*
Heated Well(s)	X		
Refrigerated Well(s)		X	
Heated Shelf (Shelves)	X		
Refrigerated Shelf (Shelves)		X	
Hot/Cold Well(s)			X
Hot/ Cold Shelf (Shelves)			X

* Warm White can range from 2700-3200K, Neutral (Cool) White from 4000-4300K



Glo-Ray® Infrared Strip Heaters

Safely hold the temperature of your product without drying out or further cooking food with Hatco's Glo-Ray® Infrared Strip Heaters. The end result is hot, fresh food that's ready-to-serve. The continuous aluminum housing and heavy-duty mountings ensure the durability and quality of Hatco products. Heavy-duty stainless steel housings are available (see next page).

- Ensures maximum flavor, safety and holding time
- Even heat distribution – no “cold spots”
- Sturdy extruded aluminum housings that do not sag, from 18" to 144" (12")
- Reflector does not blacken, maintaining a consistent heat pattern
- Heavy-duty insulation minimizes heat loss
- Optional sneeze guards (excludes stainless steel models)
- Available in stainless steel housing 18" to 96"
- Available with lights (shatter resistant incandescent lights or optional halogen lights - excludes stainless steel models)

- Pre-focused heat pattern bathes entire holding surface
- Additional reflector styles and lower wattage elements available, consult factory for more information

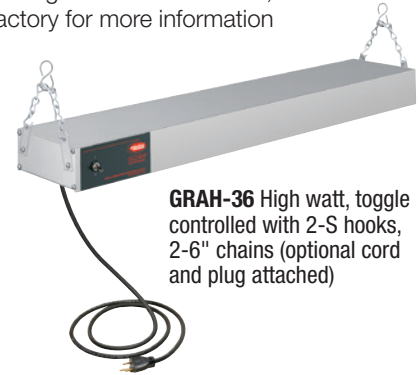

GRAH-36 High watt, toggle controlled with 2-S hooks, 2-6" chains (optional cord and plug attached)

Toggle Switch: Max. 15 Amps
Infinite Switch: Max. 12.2 Amps

ALUMINUM STRIP HEATERS WITH CONDUIT (Standard Watt)

Model ^o	Width	Voltage		Watts	Ship Weight
		Single Phase			
Standard Watt					
GRA-18	18"	120, 208 or 240		250	7 lbs.
GRA-24	24"	120, 208 or 240		350	7 lbs.
GRA-30	30"	120, 208 or 240		450	8 lbs.
GRA-36	36"	120, 208 or 240		575	9 lbs.
GRA-42	42"	120, 208 or 240		675	11 lbs.
GRA-48	48"	120, 208 or 240		800	11 lbs.
GRA-54	54"	120, 208 or 240		925	13 lbs.
GRA-60	60"	120, 208 or 240		1050	14 lbs.
GRA-66	66"	120, 208 or 240		1160	16 lbs.
GRA-72	72"	120, 208 or 240		1275	17 lbs.
GRA-84 ^v	84"	120, 208 or 240		1500	21 lbs.
GRA-96 ^v	96"	120, 208 or 240		1725	23 lbs.
GRA-108	108"	120, 208 or 240		1850	24 lbs.
GRA-120	120"	120, 208 or 240		2100	26 lbs.
GRA-132	132"	120, 208 or 240		2320	30 lbs.
GRA-144	144"	120, 208 or 240		2550	33 lbs.

^o Does not include Remote Control Box (RMB), see pages 34 and 35.

^v When using an infinite control with 120 volt model, additional switch(es) and tandem (end-to-end) elements are required, cord not available.

[^] 120 volt models require additional switches and tandem (end-to-end) elements.

All Aluminum Models Feature:

Toggle Switch (max. 15 Amps) Location: Chef's left side (unless otherwise specified).

Leads: 3' conduit with leads – server's right. NEMA 5-15P cord available on 120 volt models 72" or less with C-leg, T-leg stand or chain-hook mount. GRAH-66 and GRAH-72 require NEMA 5-20P cord for Canada.

Dimensions: 18"-144"W x 6"D x 2½"H.

OPTIONS AND ACCESSORIES – PAGE 8 RECOMMENDED MOUNTING HEIGHTS – PAGE 32

ALUMINUM STRIP HEATERS WITH CONDUIT (High Watt)

Model ^o	Width	Voltage		Watts	Ship Weight
		Single Phase			
High Watt					
GRAH-18	18"	120, 208 or 240		350	7 lbs.
GRAH-24	24"	120, 208 or 240		500	8 lbs.
GRAH-30	30"	120, 208 or 240		660	8 lbs.
GRAH-36	36"	120, 208 or 240		800	11 lbs.
GRAH-42	42"	120, 208 or 240		950	12 lbs.
GRAH-48	48"	120, 208 or 240		1100	13 lbs.
GRAH-54	54"	120, 208 or 240		1250	14 lbs.
GRAH-60	60"	120, 208 or 240		1400	16 lbs.
GRAH-66 ^v	66"	120, 208 or 240		1560	17 lbs.
GRAH-72 ^v	72"	120, 208 or 240		1725	18 lbs.
GRAH-84 [^]	84"	120, 208 or 240		2050	19 lbs.
GRAH-96 [^]	96"	120, 208 or 240		2400	21 lbs.
GRAH-108	108"	120, 208 or 240		2500	23 lbs.
GRAH-120	120"	120, 208 or 240		2800	26 lbs.
GRAH-132	132"	120, 208 or 240		3120	31 lbs.
GRAH-144	144"	120, 208 or 240		3450	48 lbs.

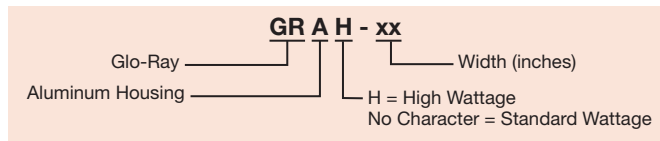

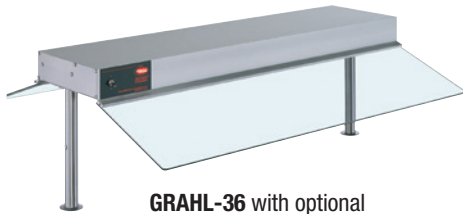

GRAHL-36 with optional sneeze guards and adjustable tubular stands

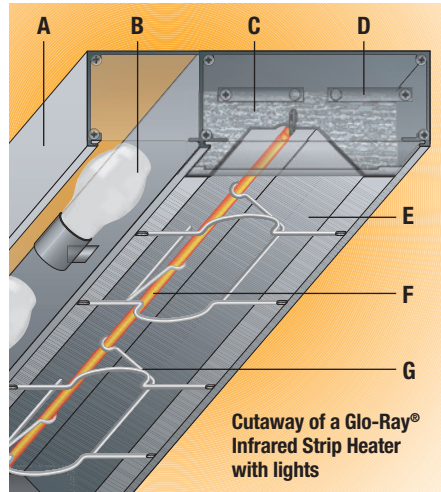

- A** Stainless steel or sturdy aluminum housings that do not sag, from 18" up to 144" (12') in 6" increments. Stainless steel units available as single units without lights, up to 96" in width
- B** Shatter-resistant incandescent lights (Standard on GRAL/GRAHL), optional halogen bulb available
- C** Heavy-duty insulation minimizes heat loss
- D** Standard hanger tabs are provided
- E** Aluminized reflector retains full heat intensity and directs more heat towards the edges of the holding surface
- F** Metal-sheathed heating element part guaranteed against burnout and breakage for two years
- G** Protective wire guard supports heating element without affecting heat distribution

ALUMINUM STRIP HEATERS WITH LIGHTS

Model [○]	Bulbs	Width	Voltage		Watts	Ship Weight
			Single Phase			
Standard Watt						
GRAL-18	2	18"	120, 120/208 or 120/240		370	9 lbs.
GRAL-24	2	24"	120, 120/208 or 120/240		470	10 lbs.
GRAL-30	2	30"	120, 120/208 or 120/240		570	12 lbs.
GRAL-36	3	36"	120, 120/208 or 120/240		755	13 lbs.
GRAL-42	3	42"	120, 120/208 or 120/240		855	15 lbs.
GRAL-48	4	48"	120, 120/208 or 120/240		1040	17 lbs.
GRAL-54	4	54"	120, 120/208 or 120/240		1165	19 lbs.
GRAL-60	5	60"	120, 120/208 or 120/240		1350	21 lbs.
GRAL-66	5	66"	120, 120/208 or 120/240		1460	22 lbs.
GRAL-72	6	72"	120, 120/208 or 120/240		1635	24 lbs.
GRAL-84 [▼]	7	84"	120, 120/208 or 120/240		1920	28 lbs.
GRAL-96 [▼]	8	96"	120, 120/208 or 120/240		2205	32 lbs.
GRAL-108	9	108"	120, 120/208 or 120/240		2390	36 lbs.
GRAL-120	10	120"	120, 120/208 or 120/240		2700	40 lbs.
GRAL-132	11	132"	120, 120/208 or 120/240		2980	44 lbs.
GRAL-144	12	144"	120, 120/208 or 120/240		3270	48 lbs.
High Watt						
GRAHL-18	2	18"	120, 120/208 or 120/240		470	9 lbs.
GRAHL-24	2	24"	120, 120/208 or 120/240		620	10 lbs.
GRAHL-30	2	30"	120, 120/208 or 120/240		780	12 lbs.
GRAHL-36	3	36"	120, 120/208 or 120/240		980	13 lbs.
GRAHL-42	3	42"	120, 120/208 or 120/240		1130	16 lbs.
GRAHL-48	4	48"	120, 120/208 or 120/240		1340	17 lbs.
GRAHL-54	4	54"	120, 120/208 or 120/240		1490	19 lbs.
GRAHL-60	5	60"	120, 120/208 or 120/240		1700	21 lbs.
GRAHL-66 [▼]	5	66"	120, 120/208 or 120/240		1860	22 lbs.
GRAHL-72 [▼]	6	72"	120, 120/208 or 120/240		2085	34 lbs.
GRAHL-84 [▲]	7	84"	120, 120/208 or 120/240		2470	28 lbs.
GRAHL-96 [▲]	8	96"	120, 120/208 or 120/240		2880	33 lbs.
GRAHL-108	9	108"	120, 120/208 or 120/240		3040	36 lbs.
GRAHL-120	10	120"	120, 120/208 or 120/240		3400	40 lbs.
GRAHL-132	11	132"	120, 120/208 or 120/240		3780	44 lbs.
GRAHL-144	12	144"	120, 120/208 or 120/240		4170	48 lbs.

[○] Does not include Remote Control Box (RMB), see pages 34 and 35.
[▼] When using an Infinite Control with 120 volt model, additional switch(es) and tandem (end-to-end) elements are required, cord not available.
[▲] 120 volt models require additional switches and tandem (end-to-end) elements.

All Aluminum Models with Conduit and Lights Feature:
Toggle Switch (max. 15 Amps) Location: Chef's left side – light side (unless otherwise specified).
Leads: 3' conduit with leads – server's right. NEMA 5-15P cord available on 120 volt models 72" or less with C-leg, T-leg stand or hook-chain mount. GRAHL-54, GRAHL-60, GRAL-66 & GRAL-72 require NEMA 5-20P cord for Canada. GRAHL-66 & GRAHL-72 require NEMA 5-20P cord - not available for Canada.
Dimensions: 18"-144"W x 9"D x 2 1/2"H.

OPTIONS AND ACCESSORIES – PAGE 8
RECOMMENDED MOUNTING HEIGHTS – PAGE 32

STAINLESS STEEL STRIP HEATERS

Model [○]	Width	Voltage		Watts	Ship Weight
		Single Phase			
Standard Watt					
GR-18	18"	120, 208 or 240		250	8 lbs.
GR-24	24"	120, 208 or 240		350	9 lbs.
GR-36	36"	120, 208 or 240		575	11 lbs.
GR-48	48"	120, 208 or 240		800	13 lbs.
GR-60	60"	120, 208 or 240		1050	16 lbs.
GR-72	72"	120, 208 or 240		1275	19 lbs.
GR-96 [*]	96"	120, 208 or 240		1725	25 lbs.
High Watt					
GRH-18	18"	120, 208 or 240		350	8 lbs.
GRH-24	24"	120, 208 or 240		500	9 lbs.
GRH-36	36"	120, 208 or 240		800	11 lbs.
GRH-48	48"	120, 208 or 240		1100	15 lbs.
GRH-60	60"	120, 208 or 240		1400	16 lbs.
GRH-72 [*]	72"	120, 208 or 240		1725	19 lbs.
GRH-96	96"	208 or 240		2400	25 lbs.

[○] Does not include Remote Control Box (RMB), see pages 34 and 35.
^{*} Infinite Switch not available in 120V.

All Stainless Steel Models Feature:
Toggle Switch (max. 15 Amps) Location: Chef's left side.
Leads: 3' conduit with leads – server's right. NEMA 5-15P cord available on 120 volt models 72" or less with C-leg, T-leg stand or chain-hook mount. GRH-72 requires NEMA 5-20P cord for Canada.
Dimensions: 18"-96"W x 6"D x 2 3/4"H.
Contact factory for stainless marine applications.

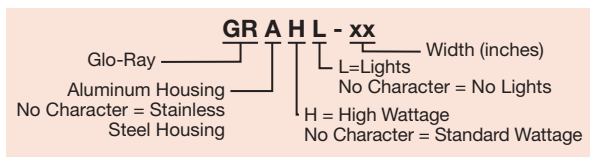



GRAHL-48
with optional
sneeze guard

OPTIONS (available at time of purchase only)

Designer colors, aluminum models 18"-144" – Non-Standard colors are non-returnable – Clear Anodized Standard –

COLOR-6	6" Housing for GRA and GRAH models (color selection below)					
COLOR-9	9" Housing for GRAL and GRAHL models (color selection below)					
	RED	Warm Red	GRAY	Gray Granite	NAVY	Navy Blue
	BLACK	Black	WHITE	White Granite	GREEN	Hunter Green
					COPPER	Antique Copper

Gloss finishes, aluminum models 18"-144" – Non-Standard colors are non-returnable –

GLOSS-6	6" Housing for GRA and GRAH models (finish selection below)					
GLOSS-9	9" Housing for GRAL and GRAHL models (finish selection below)					
	RRED	Radiant Red	GGRAY	Glossy Gray	BBLACK	Bold Black
	GGOLD	Gleaming Gold	BBLUE	Brilliant Blue		

IND. LGT Indicator Light (Remote Control only on all Tandem Element units)

Power Leads – Extended beyond Standard 3' Conduit (must specify lead length) –

LEADS5	1'-5' extended Electrical Leads
LEADS10	6'-10' extended Electrical Leads
LEADS15	11'-15' extended Electrical Leads
LEADS20	16'-20' extended Electrical Leads

9.375BP1 9 $\frac{3}{8}$ " Sneeze Guard (aluminum models only) one side

9.375BP2 9 $\frac{3}{8}$ " Sneeze Guard (aluminum models only) two sides

14BP1 14" Sneeze Guard (aluminum models only) one side

14BP2 14" Sneeze Guard (aluminum models only) two sides

HAL 60 Watt Halogen Bulb in lieu of Standard Display Light (aluminum models only)

NO BULB No bulb option (GRAL, GRAHL models only)

LIGHTS-ADD'L Extra Lamps – Installed (max. two per ft. less one per foot is Standard) must be ordered with remote switches only, aluminum models only

3 ANEAL REFL Bright Annealed Reflector for Lights (aluminum models only)

NO CONTROL No control included (GRA, GRAH, GRAL, GRAHL, GR, GRH models only) Requires selection of RMB2-xx control – see page 34

BLT INF Infinite Control Built-In in lieu of Toggle (max. 12.2 Amps) (remote installation recommended)

REM INF Remote Infinite Switches in lieu of Toggle (max. 12.2 Amps)

REM TOG Remote Toggle Switches (max. 15 Amps)

RMB Remote Box (available in *Designer* colors or Gloss finishes) – Non-Standard colors are non-returnable – see pages 34 and 35

ATL Adjustable Tubular Stands 10"-14" (not available in *Designer* colors) – Not available with cord

NTL-10, -12 Non-Adjustable Tubular Stands (specify 10" or 12" clearance) – Not available with cord

NTL-14, -16 Non-Adjustable Tubular Stands (specify 14" or 16" clearance) – Not available with cord

NTL-PAINT *Designer* color or Gloss finish for Non-Adjustable Tubular Stands – Non-Standard colors are non-returnable –

CL-LOW C-Leg Stands, Standard Watt – 10" clearance (for models up to 72" wide) – Only available with cord

CL-HIGH C-Leg Stands, High Watt – 13 $\frac{1}{2}$ " clearance (for models up to 72" wide) – Only available with cord

TL-10 T-Leg Stands, Standard Watt – 10" clearance (for models only up to 72" wide) – Only available with cord

TL-13 T-Leg Stands, 13 $\frac{1}{2}$ " clearance (for models up to 72" wide) – Only available with cord

TL-16 T-Leg Stands, 16" clearance (for models up to 72" wide) – Only available with cord

TL-18 T-Leg Stands, 18" clearance (for models up to 72" wide) – Only available with cord

CAP Attached 6' Cord and Plug Set (120V only) on models up to 72" wide, requires Standard Chain Mount Kit (two S Hooks with two 6" lengths of chain) or add optional C-leg Stands or T-leg Stands (see specific model for plug configuration)

CHAIN-HOOK Two S Hooks with two 6" lengths of chain

ACCESSORIES (available for purchase at any time)

ADJ ANGLE Adjustable Angle Brackets (GRA, GRAH models only) (see page 33 for illustration)

ADJ ANGLE7 7" tall Adjustable Angle Brackets (see page 33 for illustration)

GR-ANGLE Adjustable Angle Brackets (GR models only) (see page 33 for illustration)

CHAIN 1 Chain Suspension (see page 33 for illustration)

Chef LED 120V adjustable bulb – GRAL, GRAHL models only, all voltages –

GRAHL requires pass-through usage only and unit must be 10" or higher from surface.		
Contact your local representative or the factory for up-to-date listing of installations and applicable models		
CLED-2700-120	Warm light	CLED-3000-120 Warm light
		CLED-4000-120 Cool light



Chef LED Bulb

Glo-Ray® Dual Infrared Strip Heaters

Create a deeper holding area with Glo-Ray® Aluminum Dual Infrared Strip Heaters mounted side-by-side, keeping hot food at optimum serving temperatures. The pre-focused heat pattern directs heat from a metal-sheathed element across the entire holding surface. The continuous aluminum housing and heavy-duty mountings ensure the durability and quality of Hatco products.

- Ensures maximum flavor, safety and holding time
- Provides even heat distribution, no "cold spots"
- Sturdy extruded aluminum housings that do not sag, from 18" to 144" (12')
- Reflector does not blacken, maintaining a consistent heat pattern
- Protective wire guard supports heating element without affecting heat distribution
- 3" or 6" spacer available
- Heavy-duty insulation minimizes heat loss
- Additional reflector styles and lower wattage elements available, consult factory for more information



GRAH-72D with optional *Designer* color, 6" spacer and tandem elements

GRA-36D with Standard 3" spacer

Toggle Switch: Max. 15 Amps
Infinite Switch: Max. 12.2 Amps

NOTE: 120V models may require additional switches.

ALUMINUM DUAL STRIP HEATERS

Model ^o	Width	Voltage		Watts	Ship Weight
		Single Phase			
Standard Watt					
GRA-18D	18"	120, 208 or 240		500	14 lbs.
GRA-24D	24"	120, 208 or 240		700	16 lbs.
GRA-30D	30"	120, 208 or 240		900	18 lbs.
GRA-36D	36"	120, 208 or 240		1150	19 lbs.
GRA-42D	42"	120, 208 or 240		1350	23 lbs.
GRA-48D	48"	120, 208 or 240		1600	27 lbs.
GRA-54D	54"	120, 208 or 240		1850	30 lbs.
GRA-60D	60"	120, 208 or 240		2100	35 lbs.
GRA-66D	66"	120, 208 or 240		2320	36 lbs.
GRA-72D	72"	120, 208 or 240		2550	40 lbs.
GRA-84D ^v	84"	120, 208 or 240		3000	50 lbs.
GRA-96D ^v	96"	120, 208 or 240		3450	52 lbs.
GRA-108D	108"	120, 208 or 240		3700	59 lbs.
GRA-120D	120"	120, 208 or 240		4200	66 lbs.
GRA-132D ^p	132"	120, 208 or 240		4640	73 lbs.
GRA-144D	144"	120, 208 or 240		5100	80 lbs.
High Watt					
GRAH-18D	18"	120, 208 or 240		700	14 lbs.
GRAH-24D	24"	120, 208 or 240		1000	16 lbs.
GRAH-30D	30"	120, 208 or 240		1320	18 lbs.
GRAH-36D	36"	120, 208 or 240		1600	19 lbs.
GRAH-42D	42"	120, 208 or 240		1900	23 lbs.
GRAH-48D	48"	120, 208 or 240		2200	27 lbs.
GRAH-54D	54"	120, 208 or 240		2500	30 lbs.
GRAH-60D	60"	120, 208 or 240		2800	35 lbs.
GRAH-66D ^v	66"	120, 208 or 240		3120	36 lbs.
GRAH-72D ^v	72"	120, 208 or 240		3450	40 lbs.
GRAH-84D ^a	84"	120, 208 or 240		4100	50 lbs.
GRAH-96D ^a	96"	120, 208 or 240		4800	52 lbs.
GRAH-108D	108"	120, 208 or 240		5000	59 lbs.
GRAH-120D ^p	120"	120, 208 or 240		5600	66 lbs.
GRAH-132D ^p	132"	208 or 240		6240	73 lbs.
GRAH-144D	144"	208 or 240		6900	80 lbs.

^o Does not include Remote Control Box (RMB), see pages 34 and 35.

^v When using an infinite control with 120 volt model, additional switch(es) and tandem (end-to-end) elements are required.

^p Available with RMB or remote switch only.

^a 120 volt models require additional switches and tandem (end-to-end) elements.

All Aluminum Dual Models with Conduit Feature:

Toggle Switch (max. 15 Amps) Location: Chef's left side (unless otherwise specified).

Leads: 3' conduit with leads – server's right.

Dimensions: with 3" Spacer (Standard): 18"-144"W x 15"D x 2½"H.

with 6" Spacer: 18"-144"W x 18"D x 2½"H.

OPTIONS AND ACCESSORIES – PAGE 11

RECOMMENDED MOUNTING HEIGHTS – PAGE 32

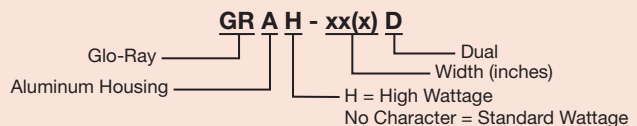



Glo-Ray® Dual Infrared Strip Heaters *continued*

- A** Shown with optional lights (shatter-resistant incandescent lights or halogen bulbs available)
- B** Sturdy extruded aluminum housings that do not sag, from 18" up to 144" (12')
- C** Reflector does not blacken, maintaining a consistent heat pattern
- D** Standard hanger tab is provided for under shelf or chain installation
- E** Heavy-duty insulation minimizes heat loss
- F** Metal-sheathed heating element part guaranteed against burnout and breakage for two years
- G** Protective wire guard supports heating element without affecting heat distribution

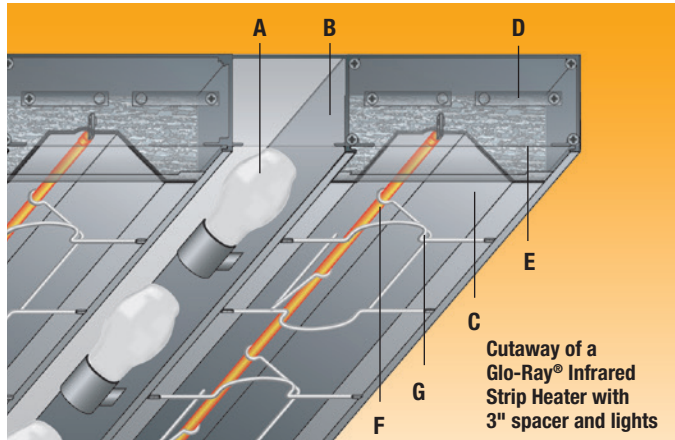

Toggle Switch: Max. 15 Amps
Infinite Switch: Max. 12.2 Amps

ALUMINUM DUAL STRIP HEATERS WITH LIGHTS

Model ^o	Bulbs	Width	Voltage	Watts	Ship Weight
			Single Phase		
Standard Watt					
GRAL-18D	2	18"	120, 120/208 or 120/240	620	14 lbs.
GRAL-24D	2	24"	120, 120/208 or 120/240	820	16 lbs.
GRAL-30D	2	30"	120, 120/208 or 120/240	1020	19 lbs.
GRAL-36D	3	36"	120, 120/208 or 120/240	1330	22 lbs.
GRAL-42D	3	42"	120, 120/208 or 120/240	1530	25 lbs.
GRAL-48D	4	48"	120, 120/208 or 120/240	1840	29 lbs.
GRAL-54D	4	54"	120, 120/208 or 120/240	2090	33 lbs.
GRAL-60D	5	60"	120, 120/208 or 120/240	2400	37 lbs.
GRAL-66D	5	66"	120, 120/208 or 120/240	2620	39 lbs.
GRAL-72D	6	72"	120, 120/208 or 120/240	2910	42 lbs.
GRAL-84D ^v	7	84"	120, 120/208 or 120/240	3420	47 lbs.
GRAL-96D ^v	8	96"	120, 120/208 or 120/240	3930	56 lbs.
GRAL-108D	9	108"	120, 120/208 or 120/240	4240	64 lbs.
GRAL-120D	10	120"	120, 120/208 or 120/240	4800	72 lbs.
GRAL-132D ^p	11	132"	120, 120/208 or 120/240	5300	79 lbs.
GRAL-144D ^p	12	144"	120, 120/208 or 120/240	5820	86 lbs.
High Watt					
GRAHL-18D	2	18"	120, 120/208 or 120/240	820	14 lbs.
GRAHL-24D	2	24"	120, 120/208 or 120/240	1120	16 lbs.
GRAHL-30D	2	30"	120, 120/208 or 120/240	1440	19 lbs.
GRAHL-36D	3	36"	120, 120/208 or 120/240	1780	22 lbs.
GRAHL-42D	3	42"	120, 120/208 or 120/240	2080	25 lbs.
GRAHL-48D	4	48"	120, 120/208 or 120/240	2440	29 lbs.
GRAHL-54D	4	54"	120, 120/208 or 120/240	2740	33 lbs.
GRAHL-60D	5	60"	120, 120/208 or 120/240	3100	37 lbs.
GRAHL-66D ^v	5	66"	120, 120/208 or 120/240	3420	39 lbs.
GRAHL-72D ^v	6	72"	120, 120/208 or 120/240	3810	42 lbs.
GRAHL-84D ^a	7	84"	120, 120/208 or 120/240	4520	47 lbs.
GRAHL-96D ^a	8	96"	120, 120/208 or 120/240	5280	56 lbs.
GRAHL-108D ^p	9	108"	120, 120/208 or 120/240	5540	64 lbs.
GRAHL-120D ^p	10	120"	120, 120/208 or 120/240	6200	72 lbs.
GRAHL-132D ^p	11	132"	120/208 or 120/240	6900	79 lbs.
GRAHL-144D ^p	12	144"	120/208 or 120/240	7620	86 lbs.

^o Does not include Remote Control Box (RMB), see pages 34 and 35.
^v When using an infinite control with 120 volt model, additional switch(es) and tandem (end-to-end) elements required.
^p Available with RMB or remote switch only.
^a 120 volt models require additional switches (available with remote switches only) and tandem (end-to-end) elements.

All Aluminum Dual Models with Conduit and Lights Feature:
 Toggle Switch (max. 15 Amps) Location: Chef's left side (unless otherwise specified).
 Leads: 3' conduit with leads – server's right.
 Dimensions: with 3" Spacer (Standard): 15"D x 2 1/2"H.
 with 6" Spacer: 18"D x 2 1/2"H.

OPTIONS AND ACCESSORIES – PAGE 11
RECOMMENDED MOUNTING HEIGHTS – PAGE 32

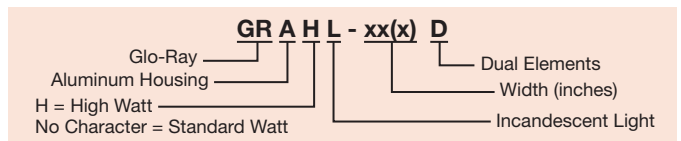



A series of **GRAH-60D** models

OPTIONS (available at time of purchase only) (not available on Quick-Ship)

Designer colors, aluminum models 18"-144" – Non-Standard colors are non-returnable – Clear Anodized Standard –

COLOR-15, -18	15" and 18" Housings for GRA, GRAH, GRAL and GRAHL Dual models (Clear Anodized Standard)
RED	Warm Red
GRAY	Gray Granite
NAVY	Navy Blue
COPPER	Antique Copper
BLACK	Black
WHITE	White Granite
GREEN	Hunter Green

Gloss finishes, aluminum models 18"-144" – Non-Standard colors are non-returnable –

GLOSS-15, -18 15" and 18" Housings for GRA, GRAH, GRAL and GRAHL Dual models (Clear Anodized Standard)

RRED	Radiant Red
GGRAY	Glossy Gray
BBLACK	Bold Black
GGOLD	Gleaming Gold
BBLUE	Brilliant Blue

IND. LGT Indicator Light (remote only)

Power Leads – Extended beyond Standard 3' Conduit (must specify lead length) –

LEADS5	1'-5' extended Electrical Leads
LEADS10	6'-10' extended Electrical Leads
LEADS15	11'-15' extended Electrical Leads
LEADS20	16'-20' extended Electrical Leads

9.375BP1 9 3/8" Sneeze Guard, one side

9.375BP2 9 3/8" Sneeze Guard, two sides

14BP1 14" Sneeze Guard, one side

14BP2 14" Sneeze Guard, two sides

HAL 60 Watt Halogen Bulb in lieu of Standard Display Light

NO BULB No bulb option (GRAL-xxD, GRAHL-xxD models only)

LIGHTS-ADD'L Extra Lamps – Installed (maximum two per ft. less one – one per ft. is Standard)

3 ANEAL REFL Bright Annealed Reflector for lights with 3" Spacer

6 ANEAL REFL Bright Annealed Reflector for lights with 6" Spacer

NO CONTROL No control included (GRA, GRAH, GRAL, GRAHL-xxD models only) Requires selection of RMB2-xx control – see page 34

REM INF Remote Infinite Switches (max. 12.2 Amps)

REM TOG Remote Toggle Switches (max. 15 Amps)

RMB Remote Box (available in *Designer* colors or Gloss finishes) – Non-Standard colors are non-returnable – see pages 34 and 35

ATL-D Adjustable Tubular Stands 10"-14" (not available in *Designer* colors)

NTL-10-D, -12-D Non-Adjustable Tubular Stands (specify 10" or 12" clearance)

NTL-14-D, -16-D Non-Adjustable Tubular Stands (specify 14" or 16" clearance)

NTL-PAINT-D *Designer* color or Gloss finish for Non-Adjustable Tubular Stands – Non-Standard colors are non-returnable –

ACCESSORIES (available for purchase at any time)

ADJ ANGLE-D Adjustable Angle Brackets for Dual models (see page 33 for illustration)

ADJ ANGLE7-D 7" tall Adjustable Angle Brackets for Dual models (see page 33 for illustration)

CHAIN 1 Chain Suspension (see page 33 for illustration)

Chef LED 120V adjustable bulb – GRAL-xxD, GRAHL-xxD models only, all voltages – pass-through usage only –

GRAL-xxD must be 15" or higher from surface, GRAHL-xxD must be 18" or higher from surface
Contact your local representative or the factory for up-to-date listing of installations and applicable models

CLED-2700-120	Warm light	CLED-3000-120	Warm light	CLED-4000-120	Cool light
----------------------	------------	----------------------	------------	----------------------	------------



Chef LED Bulb

COLORS AND FINISHES – PAGE 36



Strip Heater Solutions

Glo-Ray® Max Watt Infrared Strip Heaters

Safely hold the temperature of your product without drying out or further cooking food with Hatco's Glo-Ray® Max Watt Infrared Strip Heaters. The end result is hot, fresh food that's ready-to-serve. The continuous aluminum housing and heavy-duty mountings ensure the durability and quality of Hatco products.

- Features 25% greater wattage output than Glo-Ray high watt by comparison with single units varying in watts from 450 to 4150 watts; and units with lights varying from 570 to 4870 watts
- Sturdy extruded aluminum housings that do not sag, from 18" to 72" in 6" increments and 84" to 144" in 12" increments
- Protective wire guards under heating element
- Heavy-duty insulation minimizes heat loss
- Available options include an electronic infinite control with relay in a remote control enclosure
- Shatter-resistant incandescent lights (Standard on GRAML models) enhance product display while safeguarding food products from bulb breakage. An optional halogen bulb may be used in lieu of incandescents
- Additional reflector styles available, consult factory for more information



GRAM-36



GRAML-36 with shatter-resistant incandescent lights and Standard angle brackets

ALUMINUM MAX WATT INFRARED STRIP HEATERS

Model ⁺	Width	Voltage Single Phase	Watts	Ship Weight [◇]
Max Watt				
GRAM-18	18"	120, 208 or 240	450	6 lbs.
GRAM-24	24"	120, 208 or 240	650	7 lbs.
GRAM-30	30"	120, 208 or 240	825	8 lbs.
GRAM-36	36"	120, 208 or 240	1000	9 lbs.
GRAM-42	42"	120, 208 or 240	1175	10 lbs.
GRAM-48	48"	120, 208 or 240	1300	11 lbs.
GRAM-54	54"	120, 208 or 240	1500	13 lbs.
GRAM-60	60"	120, 208 or 240	1700	14 lbs.
GRAM-66 [⊖]	66"	120, 208 or 240	1875	16 lbs.
GRAM-72 ^{⊖▲}	72"	120, 208 or 240	2075	17 lbs.
GRAM-84 ^{⊖▲}	84"	120, 208 or 240	2400	19 lbs.
GRAM-96 ^{⊖▲▼}	96"	120, 208 or 240	2675	21 lbs.
GRAM-108 [▶]	108"	208 or 240	3000	23 lbs.
GRAM-120 [▶]	120"	208 or 240	3400	26 lbs.
GRAM-132 [▶]	132"	208 or 240	3750	30 lbs.
GRAM-144 [▶]	144"	208 or 240	4150	33 lbs.

- ◇ Add 2-8 lbs. depending on Remote Control Box (RMB).
- + Includes either Remote Control Enclosure (RMB) with toggle switch(es) and indicator light(s) or Attached Control Enclosure with toggle switch(es) except as noted (please specify).
- ⊖ 120V models available with RMB (GRAM-66, -72, -84, -96 only).
- ▲ 120V models require additional switches and tandem (end-to-end) elements.
- ▼ Electronic infinite control with 120V model requires additional switch(es) and tandem (end-to-end) elements, cord not available.
- ▶ Available with Remote Control Enclosure only (RMB). Models 108"-144" contain tandem (end-to-end) elements that may be individually controlled.

All Aluminum Max Watt Infrared Models Feature:

Includes: Angle Brackets and Attached or Remote Control Enclosure (RMB).
Leads: 3' conduit with leads – server's right.
Dimensions: 18"-144"W x 6"D x 2 1/2"H.

ALUMINUM MAX WATT INFRARED STRIP HEATERS WITH LIGHTS

Model ⁺	Bulbs	Width	Voltage Single Phase	Watts	Ship Weight [◇]
Max Watt					
GRAML-18	2	18"	120, 120/208 or 120/240	570	9 lbs.
GRAML-24	2	24"	120, 120/208 or 120/240	770	10 lbs.
GRAML-30	2	30"	120, 120/208 or 120/240	945	11 lbs.
GRAML-36	3	36"	120, 120/208 or 120/240	1180	13 lbs.
GRAML-42	3	42"	120, 120/208 or 120/240	1355	15 lbs.
GRAML-48	4	48"	120, 120/208 or 120/240	1540	17 lbs.
GRAML-54	4	54"	120, 120/208 or 120/240	1740	19 lbs.
GRAML-60 [⊖]	5	60"	120, 120/208 or 120/240	2000	21 lbs.
GRAML-66 ^{⊖▲}	5	66"	120, 120/208 or 120/240	2175	22 lbs.
GRAML-72 ^{⊖▲}	6	72"	120, 120/208 or 120/240	2435	24 lbs.
GRAML-84 ^{⊖▲}	7	84"	120, 120/208 or 120/240	2820	28 lbs.
GRAML-96 ^{⊖▲▼}	8	96"	120, 120/208 or 120/240	3155	32 lbs.
GRAML-108 [▶]	9	108"	120/208 or 120/240	3540	36 lbs.
GRAML-120 [▶]	10	120"	120/208 or 120/240	4000	40 lbs.
GRAML-132 [▶]	11	132"	120/208 or 120/240	4410	44 lbs.
GRAML-144 [▶]	12	144"	120/208 or 120/240	4870	48 lbs.

- ◇ Add 2-8 lbs. depending on Remote Control Box (RMB).
- + Includes either Remote Control Enclosure (RMB) with toggle switch(es) and indicator light(s) or Attached Control Enclosure with toggle switch(es) except as noted (please specify).
- ⊖ 120V models available with RMB (GRAML-60, -66, -72, 84 only).
- ▲ 120V models require additional switch(es) and tandem (end-to-end) elements.
- ▶ Available with Remote Control Enclosure (RMB) only. Models 96"-144" contain tandem (end-to-end) elements that may be individually controlled.
- ▼ Electronic infinite control with 120V model requires additional switch(es) and tandem (end-to-end) elements, cord not available.

All Aluminum Max Watt Infrared with Lights Models Feature:

Includes: Angle Brackets and Attached or Remote Control Enclosure (RMB).
Leads: 3' conduit with leads – server's right.
Dimensions: 18"-144"W x 9"D x 2 1/2"H.

OPTIONS AND ACCESSORIES – PAGE 13

RECOMMENDED MOUNTING HEIGHTS – PAGE 32

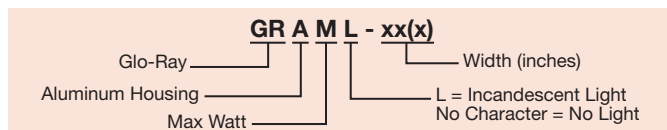



GRAML-48
with Standard
angle brackets

OPTIONS (available at time of purchase only)

Designer colors, aluminum models 18"-144" – Non-Standard colors are non-returnable – Clear Anodized Standard –

COLOR-6	6" Housing for GRAM models (select color below)					
COLOR-9	9" Housing for GRAML models (select color below)					
RMB-COLOR	Remote Control Housing in <i>Designer</i> colors (select color below)					
	RED Warm Red	GRAY Gray Granite	NAVY Navy Blue	COPPER Antique Copper		
	BLACK Black	WHITE White Granite	GREEN Hunter Green			

Gloss finishes, aluminum models 18"-144" – Non-Standard colors are non-returnable –

GLOSS-6	6" Housing for GRAM models (select finish below)					
GLOSS-9	9" Housing for GRAML models (select finish below)					
RMB-GLOSS	Remote Control Housing in Gloss finishes (select finish below)					
	RRED Radiant Red	GGRAY Glossy Gray	BBLACK Bold Black			
	GGOLD Gleaming Gold	BBLUE Brilliant Blue				

Power Leads – Extended beyond Standard 3' Conduit (must specify lead length) –

HTLEADS5	1'-5' extended Electrical Leads
HTLEADS10	6'-10' extended Electrical Leads
HTLEADS15	11'-15' extended Electrical Leads
HTLEADS20	16'-20' extended Electrical Leads
3 ANEAL REFL	Bright Annealed Reflector for lights with 3" Spacer
RMB-GRAM-INF	Remote Control Enclosure with Toggle Control Switch, Electronic Infinite Control, Relay and Indicator Light (in lieu of Standard Remote Control Box)
NTL-14, -16	Non-Adjustable Tubular Stands – specify 14" or 16" clearance
NTL-18, -20	Non-Adjustable Tubular Stands – specify 18" or 20" clearance
NTL-22, -24	Non-Adjustable Tubular Stands – specify 22" or 24" clearance
NTL-PAINT	<i>Designer</i> color or Gloss finish for Non-Adjustable Tubular Stands (one pair) – Non-Standard colors are non-returnable –
CAP	Attached 6' Cord and Plug Set (120V only) on models up to 48" requires Standard Chain Mount Kit: Two S Hooks with two 6" lengths of chain (available for GRAM models only)
CHAIN-HOOK	Two S Hooks with two 6" lengths of chain
HAL	60 Watt Halogen Bulb in lieu of Standard Display Light
NO BULB	No bulb option (GRAML models only)

ACCESSORIES (available for purchase at any time)

CHAIN 1	Chain Suspension
Chef LED 120V adjustable bulb – GRAML-xx models only, all voltages – pass-through usage only –	GRAML-xx must be 13" or higher from surface as pass through Contact your local representative or the factory for up-to-date listing of installations and applicable models
CLED-2700-120	Warm light
CLED-3000-120	Warm light
CLED-4000-120	Cool light



Chef LED Bulb

COLORS AND FINISHES – PAGE 36



Glo-Ray® Aluminum Max Watt Dual Infrared Strip Heaters

Create a deeper holding area with Glo-Ray® Max Watt Dual Aluminum Infrared Strip Heaters mounted side-by-side, keeping hot food at optimum serving temperatures. The pre-focused heat pattern directs heat from a metal-sheathed element, bathing the entire holding surface. The continuous aluminum housing and heavy-duty mountings ensure the durability and quality of Hatco products.

- Features 25% greater wattage output than Glo-Ray high watt by comparison with dual units varying in wattage from 900 to 8300 watts; and units with lights varying from 1020 to 9020 watts
- Sturdy extruded aluminum housings that do not sag, from 18" to 72" in 6" increments and 84" to 144" in 12" increments
- Protective wire guard supports heating element without affecting heat distribution
- 3" or 6" spacer available
- Heavy-duty insulation minimizes heat loss
- Shatter-resistant incandescent lights (Standard on GRAML models) enhance product display while safeguarding food products from bulb breakage. An optional halogen bulb may be used in lieu of incandescents
- Additional reflector styles available, consult factory for more information



GRAM-36D
with Standard 3" spacer

GLO-RAY® ALUMINUM MAX WATT DUAL INFRARED STRIP HEATERS

Model ⁺	Width	Voltage		Watts	Ship Weight [◇]
		Single Phase			
Max Watt					
GRAM-18D	18"	120, 208 or 240		900	14 lbs.
GRAM-24D	24"	120, 208 or 240		1300	16 lbs.
GRAM-30D	30"	120, 208 or 240		1650	18 lbs.
GRAM-36D	36"	120, 208 or 240		2000	21 lbs.
GRAM-42D	42"	120, 208 or 240		2350	24 lbs.
GRAM-48D	48"	120, 208 or 240		2600	27 lbs.
GRAM-54D	54"	120, 208 or 240		3000	30 lbs.
GRAM-60D	60"	120, 208 or 240		3400	34 lbs.
GRAM-66D [▶]	66"	120, 208 or 240		3750	37 lbs.
GRAM-72D [▶]	72"	120, 208 or 240		4150	41 lbs.
GRAM-84D [▶]	84"	120, 208 or 240		4800	44 lbs.
GRAM-96D ^{▶▼}	96"	120, 208 or 240		5350	52 lbs.
GRAM-108D	108"	208 or 240		6000	59 lbs.
GRAM-120D	120"	208 or 240		6800	66 lbs.
GRAM-132D	132"	208 or 240		7500	73 lbs.
GRAM-144D	144"	208 or 240		8300	80 lbs.

◇ Add 2-8 lbs. depending on Remote Control Box (RMB).

+ Includes Remote Control Enclosure (RMB) with toggle switch(es) and indicator light(s)

▶ 120 volt models require RMB-GRAM-INF only.

▼ When using an Infinite Control with 120 volt model, additional switch(es) and tandem (end-to-end) elements are required.

All Aluminum Max Watt Dual Models Feature:

Includes: Angle Brackets and Remote Control Enclosure (RMB).

Leads: 3' conduit with leads – server's right.

Dimensions: with 3" Spacer (Standard): 18"-144"W x 15"D x 2½"H.
with 6" Spacer: 18"-144"W x 18"D x 2½"H.

OPTIONS AND ACCESSORIES – PAGE 16
RECOMMENDED MOUNTING HEIGHTS – PAGE 32

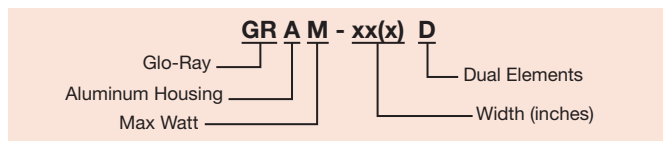

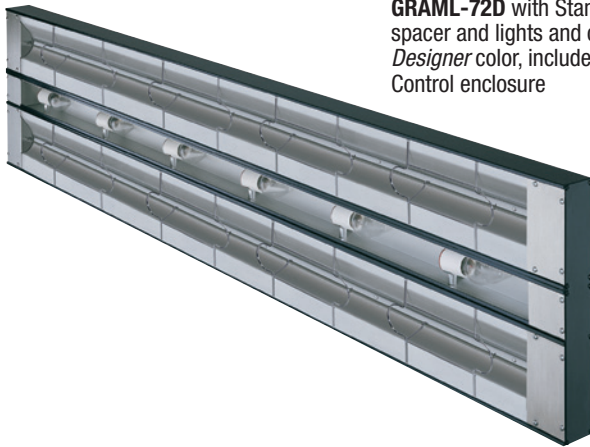

GRAML-72D with Standard 3" spacer and lights and optional Black Designer color, includes Remote Control enclosure

ALUMINUM MAX WATT DUAL STRIP HEATERS WITH LIGHTS

Model ⁺	Bulbs	Width	Voltage Single Phase	Watts	Ship Weight [◇]
Max Watt					
GRAML-18D	2	18"	120, 120/208 or 120/240	1020	14 lbs.
GRAML-24D	2	24"	120, 120/208 or 120/240	1420	16 lbs.
GRAML-30D	2	30"	120, 120/208 or 120/240	1770	19 lbs.
GRAML-36D	3	36"	120, 120/208 or 120/240	2180	22 lbs.
GRAML-42D	3	42"	120, 120/208 or 120/240	2530	25 lbs.
GRAML-48D	4	48"	120, 120/208 or 120/240	2840	29 lbs.
GRAML-54D	4	54"	120/208 or 120/240	3240	34 lbs.
GRAML-60D	5	60"	120/208 or 120/240	3700	37 lbs.
GRAML-66D [▲]	5	66"	120/208 or 120/240	4050	40 lbs.
GRAML-72D [▲]	6	72"	120/208 or 120/240	4510	42 lbs.
GRAML-84D [▲]	7	84"	120/208 or 120/240	5220	47 lbs.
GRAML-96D [▼]	8	96"	120/208 or 120/240	5830	56 lbs.
GRAML-108D [▼]	9	108"	120/208 or 120/240	6540	64 lbs.
GRAML-120D [▼]	10	120"	120/208 or 120/240	7400	72 lbs.
GRAML-132D [▼]	11	132"	120/208 or 120/240	8160	79 lbs.
GRAML-144D [▼]	12	144"	120/208 or 120/240	9020	86 lbs.

⁺Includes Remote Control Enclosure (RMB) with toggle switch(es) and indicator light(s).
[◇] Add 2-8 lbs. depending on Remote Control Box (RMB).
[▲] 120 volt models require RMB-GRAM-INF only.
[▼] When using an infinite control with 120 volt model, additional switch(es) and tandem (end-to-end) elements are required.
[▶] Available with Remote Control Enclosure RMB-GRAM-INF only.

Note: Other control options available, consult factory.

All Aluminum Max Watt Dual Models with Lights Feature:

Includes: Angle Brackets and Remote Control Enclosure (RMB).
Leads: 3' conduit with leads – server's right.
Dimensions: with 3" Spacer (Standard): 15"D x 2½"H.
 with 6" Spacer: 18"D x 2½"H.

OPTIONS AND ACCESSORIES – PAGE 16
RECOMMENDED MOUNTING HEIGHTS – PAGE 32

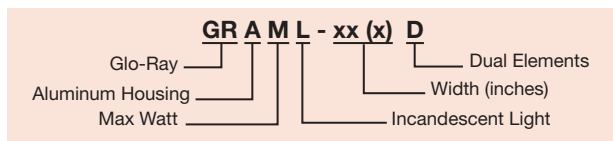



GRAML-60D with optional non-adjustable tubular stands

OPTIONS (available at time of purchase only)

Designer colors, aluminum models 18"-144" – Non-Standard colors are non-returnable – Clear Anodized Standard –

COLOR-15, -18	15" and 18" Housings for GRAM and GRAML Dual models						
RMB-COLOR	Remote Control Housing in <i>Designer</i> colors						
RED	Warm Red	GRAY	Gray Granite	NAVY	Navy Blue	COPPER	Antique Copper
BLACK	Black	WHITE	White Granite	GREEN	Hunter Green		

Gloss finishes, aluminum models 18"-144" – Non-Standard colors are non-returnable –

GLOSS-15, -18	15" and 18" Housings for GRAM and GRAML Dual models				
RMB-GLOSS	Remote Control Housing in Gloss finishes				
RRED	Radiant Red	GGRAY	Glossy Gray	BBLACK	Bold Black
GGOLD	Gleaming Gold	BBLUE	Brilliant Blue		

Power Leads – Extended beyond Standard 3' Conduit (must specify lead length) –

HTLEADS5	1'-5' extended Electrical Leads
HTLEADS10	6'-10' extended Electrical Leads
HTLEADS15	11'-15' extended Electrical Leads
HTLEADS20	16'-20' extended Electrical Leads
RMB-GRAM-INF	Remote Control Enclosure with Toggle Control Switch, Electronic Infinite Control, Relay and Indicator Light (in lieu of Standard Remote Control Box)
3 ANEAL REFL	Bright Annealed Reflector for lights with 3" Spacer
6 ANEAL REFL	Bright Annealed Reflector for lights with 6" Spacer
NTL-18-D, -20-D	Non-Adjustable Tubular Stands (specify 18" or 20" clearance)
NTL-22-D, -24-D	Non-Adjustable Tubular Stands (specify 22" or 24" clearance)
NTL-PAINT-D	<i>Designer</i> color or Gloss finish for Non-Adjustable Tubular Stands – Non-Standard colors are non-returnable –
HAL	60 Watt Halogen Bulb in lieu of Standard Display Light
NO BULB	No bulb option (GRAML-xxD models only)

COLORS AND FINISHES – PAGE 36

Glo-Ray® Narrow Halogen Strip Heaters

Hatco Glo-Ray® Narrow Halogen Strip Heaters are great for use in tight spaces and keep the focus on food items being displayed. Even the most delicate dishes hold that just-prepared look.

- Sleek, slim design with just 2½" height and 4" depth
- Halogen heat source is controlled by a dimmer switch, allowing maximum flexibility
- Xenon bulbs, controlled by a toggle switch, light food product when no extra heat is desired
- Available in widths from 18" to 72" for GRN4 models and 24" to 72" for GRN4L models

Remote Control Enclosures



For GRN4 models:
One dimmer and one toggle switch



For GRN4L models:
One dimmer and two toggle switches

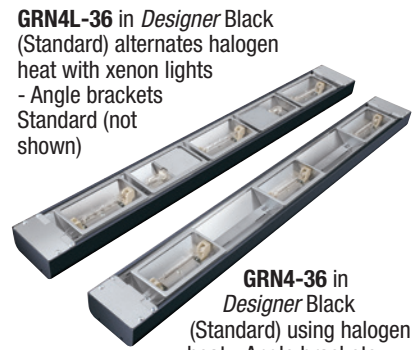

GRN4-36 in Designer Black (Standard) using halogen heat - Angle brackets Standard (not shown)

NARROW HALOGEN STRIP HEATERS

Model	No. of Elements	Width	Watts	Ship Weight [†]
GRN4-18	2	18"	400	8 lbs.
GRN4-24	2	24"	400	8 lbs.
GRN4-30	2	30"	400	10 lbs.
GRN4-36	3	36"	600	11 lbs.
GRN4-42	3	42"	600	12 lbs.
GRN4-48	3	48"	600	12 lbs.
GRN4-54	4	54"	800	15 lbs.
GRN4-60	4	60"	800	15 lbs.
GRN4-66	5	66"	1000	17 lbs.
GRN4-72	5	72"	1000	18 lbs.

[†]Includes Remote Control Enclosures (RMB) with dimmer and toggle(s).

All Narrow Halogen Models with Conduit Feature:

Voltage: 120, single phase only.

Leads: 6" leads.

Models Shipped with: 3' conduit with leads, angle brackets and Remote Control Enclosure with switch(es).

Dimensions: 18" to 72"W x 4"D x 2½"H.

NARROW HALOGEN STRIP HEATERS WITH XENON LIGHTS

Model	No. of Elements	No. of Bulbs	Width	Watts	Ship Weight [†]
GRN4L-24	2	1	24"	450	9 lbs.
GRN4L-30	2	1	30"	450	10 lbs.
GRN4L-36	3	2	36"	700	13 lbs.
GRN4L-42	3	2	42"	700	14 lbs.
GRN4L-48	3	2	48"	700	14 lbs.
GRN4L-54	4	3	54"	950	17 lbs.
GRN4L-60	4	3	60"	950	18 lbs.
GRN4L-66	5	4	66"	1200	21 lbs.
GRN4L-72	5	4	72"	1200	21 lbs.

[†]Includes Remote Control Enclosures (RMB) with dimmer and toggle(s).

All Narrow Halogen Models with Lights and Conduit Feature:

Voltage: 120, single phase only.

Leads: 6" leads.

Models Shipped with: 3' conduit with leads, angle brackets and Remote Control Enclosure with switch(es).

Dimensions: 24" to 72"W x 4"D x 2½"H.

OPTIONS AND ACCESSORIES – PAGE 18

RECOMMENDED MOUNTING HEIGHTS – PAGE 32

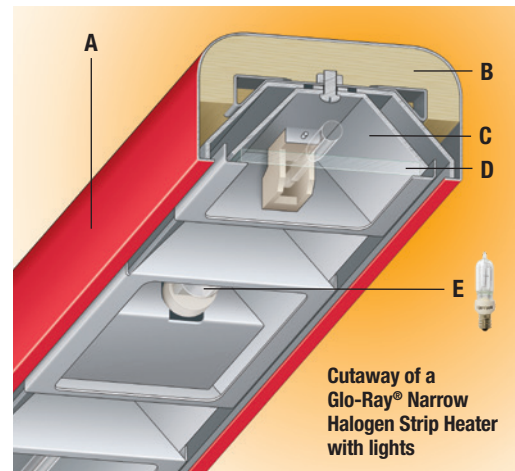
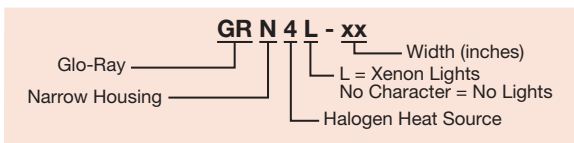

Cutaway of a Glo-Ray® Narrow Halogen Strip Heater with lights

- A** Powdercoated steel continuous housing in a variety of colors
- B** Heavy-duty insulation minimizes heat loss
- C** Aluminized reflector retains full heat intensity and directs more heat towards the edges of the holding surface
- D** Ceramic glass shields provide a safety barrier for the xenon and halogen bulbs
- E** Xenon bulbs light food when no extra heat is needed



GRN4L-54 with optional Non-Adjustable Tubular Stands (NTL) above a GR2S-42

OPTIONS (available at time of purchase only)

Designer colors – Non-Standard colors are non-returnable – Black Standard –

RED	Warm Red	GRAY	Gray Granite	NAVY	Navy Blue	COPPER	Antique Copper
BLACK	Black	WHITE	White Granite	GREEN	Hunter Green		

Gloss finishes – Non-Standard colors are non-returnable –

SWHITE	Smooth White	GGOLD	Gleaming Gold	GGRAY	Glossy Gray	BBLACK	Bold Black
---------------	--------------	--------------	---------------	--------------	-------------	---------------	------------

Stainless Steel – Non-Standard colors are non-returnable –

SS	Stainless Steel						
-----------	-----------------	--	--	--	--	--	--

Gloss finishes – Non-Standard colors are non-returnable –

RRED*	Radiant Red	BBLUE*	Brilliant Blue				
--------------	-------------	---------------	----------------	--	--	--	--

Leads (must specify lead length) –

LEADS5	1'-5' extended Electrical Leads						
LEADS10	6'-10' extended Electrical Leads						
LEADS15	11'-15' extended Electrical Leads						
LEADS20	16'-20' extended Electrical Leads						

NTL-10, -12 Non-Adjustable Tubular Stands (specify 10" or 12" clearance)

NTL-14, -16 Non-Adjustable Tubular Stands (specify 14" or 16" clearance)

NTL-PAINT Designer color or Gloss finish for Non-Adjustable Tubular Stands – Non-Standard colors are non-returnable –

Control Box Bezel – Designer colors – Non-Standard colors are non-returnable –

RED	Warm Red	GRAY	Gray Granite	NAVY	Navy Blue	COPPER	Antique Copper
BLACK	Black	WHITE	White Granite	GREEN	Hunter Green		

* Special process required and extended lead times – Non-Standard colors are non-returnable –

COLORS AND FINISHES – PAGE 36

Glo-Ray® Narrow Infrared Strip Heaters

Hatco Glo-Ray® Narrow Infrared Strip Heaters keep all hot foods at optimum serving temperatures longer, while the slim design fits ideally in buffet areas. Even the most delicate dishes hold that “just-prepared” look. The entire holding surface is heated evenly with no “cold” spots.

- Slim design that's 2" high and 4" deep
- Available in widths from 18"-72"
- Pre-focused heat pattern maintains serving temperatures longer without continuing to cook the food
- Optional Remote Control Enclosure (RMB) available in *Designer* colors



GRN-24 in Standard *Designer* Black with Standard angle brackets

Toggle Switch: Max. 15 Amps
Infinite Switch: Max. 12.2 Amps

NARROW INFRARED STRIP HEATERS

Model ¹	Width	Voltage (Single Phase)	Watts	Ship Weight
Standard Watt				
GRN-18	18"	120, 208 or 240	250	6 lbs.
GRN-24	24"	120, 208 or 240	350	7 lbs.
GRN-30	30"	120, 208 or 240	450	8 lbs.
GRN-36	36"	120, 208 or 240	575	9 lbs.
GRN-42	42"	120, 208 or 240	675	10 lbs.
GRN-48	48"	120, 208 or 240	800	11 lbs.
GRN-54	54"	120, 208 or 240	925	13 lbs.
GRN-60	60"	120, 208 or 240	1050	14 lbs.
GRN-66	66"	120, 208 or 240	1160	16 lbs.
GRN-72	72"	120, 208 or 240	1275	17 lbs.
High Watt				
GRNH-18	18"	120, 208 or 240	350	6 lbs.
GRNH-24	24"	120, 208 or 240	500	7 lbs.
GRNH-30	30"	120, 208 or 240	660	8 lbs.
GRNH-36	36"	120, 208 or 240	800	9 lbs.
GRNH-42	42"	120, 208 or 240	950	10 lbs.
GRNH-48	48"	120, 208 or 240	1100	11 lbs.
GRNH-54	54"	120, 208 or 240	1250	13 lbs.
GRNH-60	60"	120, 208 or 240	1400	14 lbs.
GRNH-66*	66"	120, 208 or 240	1560	16 lbs.
GRNH-72*	72"	120, 208 or 240	1725	17 lbs.

¹ Does not include Remote Control Box (RMB), see pages 34 and 35.

* Infinite Switch not available in 120V. RMB2-1R or RMB2-2R series Remote Control Box required.

All Narrow Infrared Models Feature:

Toggle Switch (max. 15 Amps) with Indicator Light Location: Chef's left side (unless otherwise specified).

Designer Color Angle Brackets: To match unit color and provide 1½" clearance between strip heater and overshef. Non-Standard colors are non-returnable.

Leads: 6' leads – server's right. **Dimensions:** 18"-72"W x 4"D x 2"H.

RECOMMENDED MOUNTING HEIGHTS – PAGE 32

COLORS AND FINISHES – PAGE 36

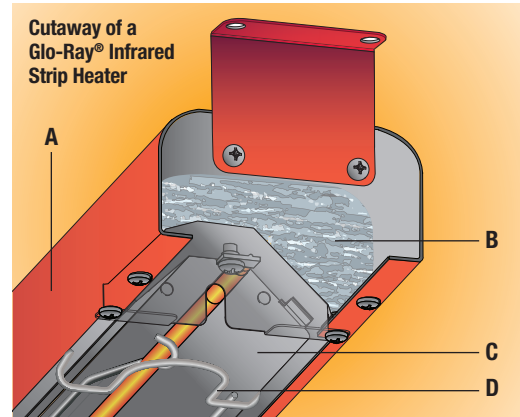

- A** Sturdy housing in stainless steel or one of seven *Designer* colors
- B** Heavy-duty insulation minimizes heat loss
- C** Aluminized reflector retains full heat intensity and directs more heat towards edges of holding surface
- D** Protective wire guard supports heating element without affecting heat distribution

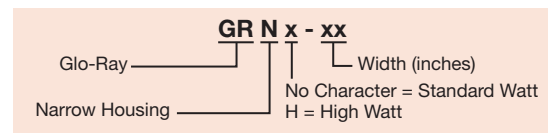

OPTIONS (available at time of purchase only)

Designer colors, models 18"-72" – Non-Standard colors are non-returnable – Black Standard –

RED	Warm Red	GRAY	Gray Granite	NAVY	Navy Blue	COPPER	Antique Copper
BLACK	Black	WHITE	White Granite	GREEN	Hunter Green		

Stainless steel – Non-Standard colors are non-returnable

SS Stainless Steel

Power Leads (must specify lead length) –

LEADS5 1'-5' extended Electrical Leads

LEADS10 6'-10' extended Electrical Leads

LEADS15 11'-15' extended Electrical Leads

LEADS20 16'-20' extended Electrical Leads

NO CONTROL No control included – Requires selection of RMB2-xx control – see page 34

RMB Remote Box (available in *Designer* colors or Gloss finishes) – Non-Standard colors are non-returnable – see page 34 and 35

TABS Stainless steel Hanger tabs in lieu of angle brackets

CAP Attached 6' Cord and Plug Set (120V only) on models up to 72" with Standard Chain Mount Kit (two S Hooks with two 6" lengths of chain) and hanger tabs (max. 1800 Watt)

CHAIN-HOOK Two S Hooks with two 6" lengths of chain

NTL-10, -12 Non-Adjustable Tubular Stands (specify 10" or 12" clearance and power location)

NTL-14, -16 Non-Adjustable Tubular Stands (specify 14" or 16" clearance and power location)

NTL-PAINT *Designer* color for Non-Adjustable Tubular Stands – Non-Standard colors are non-returnable –



Glo-Ray® Narrow Max Watt Infrared Strip Heaters

Glo-Ray® Narrow Max Watt Infrared Strip Heaters keep all hot foods at optimum serving temperatures longer, while the slim design fits ideally in buffet areas. The entire holding surface is heated evenly with no “cold” spots.

- Slim design that's 2" high and 4" deep
- Available in widths from 18"-72"
- Pre-focused heat pattern maintains serving temperatures longer without continuing to cook the food
- Available in stainless steel only



GRNM-24 in Standard stainless steel with Standard angle brackets

NARROW MAX WATT INFRARED STRIP HEATERS

Model ^o	Width	Voltage (Single Phase)	Watts	Ship Weight
GRNM-18	18"	120, 208 or 240	450	6 lbs.
GRNM-24	24"	120, 208 or 240	650	7 lbs.
GRNM-30	30"	120, 208 or 240	825	8 lbs.
GRNM-36	36"	120, 208 or 240	1000	9 lbs.
GRNM-42	42"	120, 208 or 240	1175	10 lbs.
GRNM-48	48"	120, 208 or 240	1300	11 lbs.
GRNM-54 [♦]	54"	120, 208 or 240	1500	13 lbs.
GRNM-60 [♦]	60"	120, 208 or 240	1700	14 lbs.
GRNM-66 ^{**}	66"	120, 208 or 240	1875	16 lbs.
GRNM-72 ^{**}	72"	120, 208 or 240	2075	17 lbs.

^o Does not include Remote Control Box (RMB), see pages 34 and 35.

[♦] Infinite Switch not available in 120V. RMB2-1R or RMB2-2R series Remote Control Box required.

^{**} RMB2-1R or RMB2-2R series Remote Control Box (RMB) required.

All Narrow Max Watt Infrared Models Feature:

Angle Brackets: Provides 1½" clearance between strip heater and overshef.

Leads: 6" leads – server's right.

Dimensions: 18"-72"W x 4"D x 2"H.

RECOMMENDED MOUNTING HEIGHTS – PAGE 32

OPTIONS (available at time of purchase only)

Power Leads – Extended beyond Standard 6" Leads (must specify lead length) –

HTLEADS5	1'-5' extended Electrical Leads
HTLEADS10	6'-10' extended Electrical Leads
HTLEADS15	11'-15' extended Electrical Leads
HTLEADS20	16'-20' extended Electrical Leads
NO CONTROL	No control included – Requires selection of RMB2-xx control – see page 34
RMB	Requires Remote Box – Not available with Built-In controls – see pages 34 and 35
NTL-14, -16	Non-Adjustable Tubular Stands (specify 14" or 16" clearance and power location)

GR N M - xx

Glo-Ray ————
 Narrow Housing ————
 Width (inches)
 M = Max Wattage

Glo-Ray® High Watt Infra-Black® Strip Heaters

For foodwarming at a close range to food product, the Glo-Ray® Infra-Black® heat technology is ideal, emitting a solid panel of uniform heat. Sturdy continuous single or dual extruded aluminum housings assure quality, durability and a variety of widths, depths, mounting arrangements and colors will fit your operation.

- Provides ideal amount of heat for limited space operations, mounted 4" to 10" above target surface for singles and 8" to 14" for duals
- Metal-sheathed heating element part guaranteed against burnout and breakage for two years
- Infra-Black emitter provides even heat distribution – eliminating hot spots
- Sturdy aluminum housings that do not sag, from 18" to 72" in 6" increments
- Heavy-duty insulation keeps the exterior housing cool
- Optional wire guard available to protect user from incidental contact with heated surface
- Optional 3" or 6" spacer available on dual models with or without lights (see next page)



GRAIH-36 with optional wire guard, requires Remote Control Enclosure (RMB)

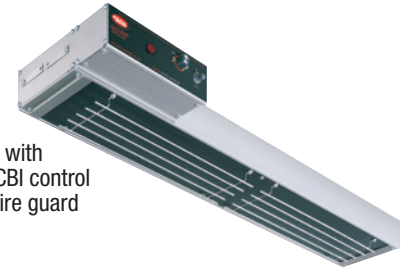

GRAIH-36 with optional TCBI control box and wire guard

Toggle Switch: Max. 15 Amps
Infinite Switch: Max. 12.2 Amps

ALUMINUM STRIP HEATERS – HIGH WATT INFRA-BLACK

Model ^o	Width	Voltage		Watts	Ship Weight [◇]
		Single Phase			
GRAIH-18	18"	120, 208 or 240		350	6 lbs.
GRAIH-24	24"	120, 208 or 240		500	11 lbs.
GRAIH-30	30"	120, 208 or 240		660	13 lbs.
GRAIH-36	36"	120, 208 or 240		800	15 lbs.
GRAIH-42	42"	120, 208 or 240		950	17 lbs.
GRAIH-48	48"	120, 208 or 240		1100	21 lbs.
GRAIH-54	54"	120, 208 or 240		1250	24 lbs.
GRAIH-60	60"	120, 208 or 240		1400	27 lbs.
GRAIH-66[◆]	66"	120, 208 or 240		1560	30 lbs.
GRAIH-72[◆]	72"	120, 208 or 240		1725	33 lbs.

ALUMINUM STRIP HEATERS – HIGH WATT INFRA-BLACK WITH LIGHTS

Model ^o	No. of Bulbs	Width	Voltage		Watts	Ship Weight [◇]
			Single Phase			
GRAIHL-18	2	18"	120, 120/208 or 120/240		470	12 lbs.
GRAIHL-24	2	24"	120, 120/208 or 120/240		620	15 lbs.
GRAIHL-30	2	30"	120, 120/208 or 120/240		780	17 lbs.
GRAIHL-36	3	36"	120, 120/208 or 120/240		980	20 lbs.
GRAIHL-42	3	42"	120, 120/208 or 120/240		1130	23 lbs.
GRAIHL-48	4	48"	120, 120/208 or 120/240		1340	26 lbs.
GRAIHL-54	4	54"	120, 120/208 or 120/240		1490	29 lbs.
GRAIHL-60	5	60"	120, 120/208 or 120/240		1700	33 lbs.
GRAIHL-66[◆]	5	66"	120, 120/208 or 120/240		1860	34 lbs.
GRAIHL-72^{◆▲}	6	72"	120, 120/208 or 120/240		2085	36 lbs.

[◇] Does not include Remote Control Box (RMB).

^o Does not include Remote Control Box (RMB) or Thermostatic Control Box with Indicator Lights (TCBI). Must choose either RMB (see pages 34 and 35) or TCBI (see OPTIONS on page 23).

[◆] Infinite Switch not available in 120V.

[▲] 120V models available with remote control only.

All High Watt Infra-Black Models Feature:

Leads: 3' conduit with leads – server's right. 6" leads when supplied with TCBI – exit side of control box.

Dimensions: **GRAIH:** 18"-72"W x 6"D x 2½"H.

GRAIHL: 18"-72"W x 9"D x 2½"H.

TCBI Control Enclosure dimensions (not including switches): 8"W x 3"D x 2½"H.

Control Enclosure location: Chef's left side – light side (unless otherwise specified).

OPTIONS AND ACCESSORIES – PAGE 23

RECOMMENDED MOUNTING HEIGHTS – PAGE 32

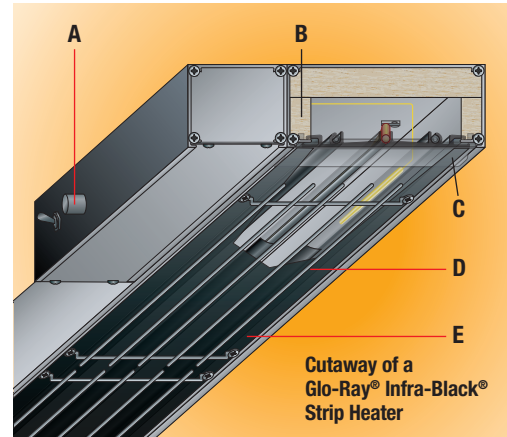

Cutaway of a Glo-Ray® Infra-Black® Strip Heater

- A** Thermostatically controlled to regulate heat and provide consistent temperature. (Optional remote infinite control available)
- B** Heavy-duty insulation minimizes heat loss
- C** Provides ideal amount of heat for limited space operations, effectively holding product
- D** Optional wire guard available to protect user from incidental contact with the heated surface
- E** Infra-Black emitter provides even heat distribution, eliminating hot spots for close applications

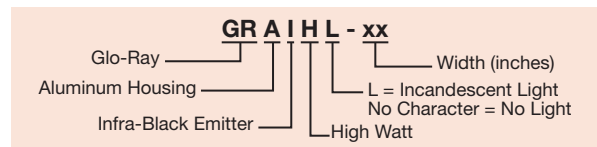



Glo-Ray® High Watt Dual Infra-Black® Strip Heaters

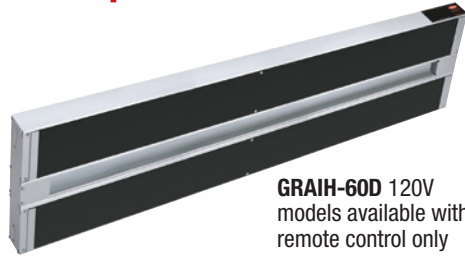

GRAIH-60D 120V
models available with
remote control only

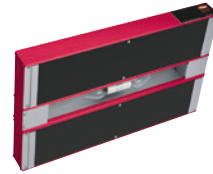

GRAIHL-24D in
optional Radiant Red
Gloss finish

Toggle Switch: Max. 15 Amps
Infinite Switch: Max. 12.2 Amps

DUAL ALUMINUM STRIP HEATERS – HIGH WATT INFRA-BLACK

Model [○]	Width	Voltage		Watts	Ship Weight [◇]
		Single Phase			
GRAIH-18D	18"	120, 208 or 240		700	13 lbs.
GRAIH-24D	24"	120, 208 or 240		1000	19 lbs.
GRAIH-30D	30"	120, 208 or 240		1320	21 lbs.
GRAIH-36D	36"	120, 208 or 240		1600	24 lbs.
GRAIH-42D [△]	42"	120, 208 or 240		1900	27 lbs.
GRAIH-48D [△]	48"	120, 208 or 240		2200	32 lbs.
GRAIH-54D [△]	54"	120, 208 or 240		2500	35 lbs.
GRAIH-60D [△]	60"	120, 208 or 240		2800	39 lbs.
GRAIH-66D ^{△♦}	66"	120, 208 or 240		3120	42 lbs.
GRAIH-72D ^{△♦☆}	72"	120, 208 or 240		3450	46 lbs.

DUAL ALUMINUM STRIP HEATERS – HIGH WATT INFRA-BLACK WITH LIGHTS

Model [○]	No. of Bulbs	Width	Voltage		Watts	Ship Weight [◇]
			Single Phase			
GRAIHL-18D	2	18"	120, 120/208 or 120/240		820	18 lbs.
GRAIHL-24D	2	24"	120, 120/208 or 120/240		1120	21 lbs.
GRAIHL-30D	2	30"	120, 120/208 or 120/240		1440	23 lbs.
GRAIHL-36D	3	36"	120, 120/208 or 120/240		1780	27 lbs.
GRAIHL-42D [△]	3	42"	120, 120/208 or 120/240		2080	30 lbs.
GRAIHL-48D [△]	4	48"	120, 120/208 or 120/240		2440	35 lbs.
GRAIHL-54D [△]	4	54"	120, 120/208 or 120/240		2740	38 lbs.
GRAIHL-60D [△]	5	60"	120, 120/208 or 120/240		3100	42 lbs.
GRAIHL-66D ^{△♦☆}	5	66"	120, 120/208 or 120/240		3420	44 lbs.

[◇] Does not include Remote Control Box (RMB).

[○] Does not include Remote Control Box (RMB) or Thermostatic Control Box with Indicator Lights (TCBI).
Must choose either RMB (see pages 34 and 35) or TCBI (see OPTIONS on page 23).

[△] 120V models available with remote control only.

[♦] Infinite Switch not available in 120V.

[☆] TCBI not available in 208V, 120/208V.

All Dual High Watt Infra-Black Models Feature:

Leads: 3' conduit with leads – server's right. 6" leads when supplied with TCBI – exit side of control box.

Dimensions: GRAIH-xxD with 3" Spacer: 18"-72"W x 15"D x 2½"H.

GRAIHL-xxD with 3" Spacer: 18"-66"W x 15"D x 2½"H.

GRAIH-xxD with 6" Spacer: 18"-72"W x 18"D x 2½"H.

GRAIHL-xxD with 6" Spacer: 18"-66"W x 18"D x 2½"H.

TCBI Control Enclosure dimensions (not including switches): 8"W x 3"D x 2½"H.

Control Enclosure location: Chef's left side – light side (unless otherwise specified).

OPTIONS AND ACCESSORIES – PAGE 23

RECOMMENDED MOUNTING HEIGHTS – PAGE 32

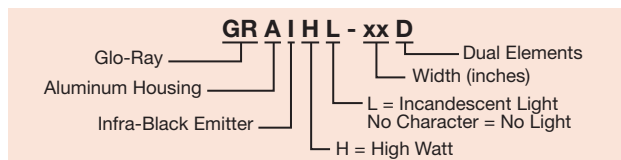



GRAIH-72 with optional wire guard, requires Remote Control Enclosure (RMB)

OPTIONS (available at time of purchase only)

Designer colors – Non-Standard colors are non-returnable –

COLOR-6, -9	6" Housing for GRAIH models and 9" Housing for GRAIHL models (color selection below)						
COLOR-15, -18	15" and 18" Housings for GRAIH and GRAIHL Dual models (color selection below)						
RED	Warm Red	GRAY	Gray Granite	NAVY	Navy Blue	COPPER	Antique Copper
BLACK	Black	WHITE	White Granite	GREEN	Hunter Green		

Gloss finishes – Non-Standard colors are non-returnable –

GLOSS-6, -9	6" Housing for GRAIH models and 9" Housing for GRAIHL models (finish selection below)						
GLOSS-15, -18	15" and 18" Housings for GRAIH and GRAIHL Dual models (finish selection below)						
RRED	Radiant Red	GGRAY	Glossy Gray	BBLACK	Bold Black		
GGOLD	Gleaming Gold	BBLUE	Brilliant Blue				

AIH18WG -AIH72WG	Element Wire Guard (Dual models require two sets)
HAL	60 Watt Halogen Bulb in lieu of Standard Display Light
NO CONTROL	No control included (GRAIH, GRAIHL-xx, GRAIH, GRAIHL-xxD models only) Requires selection of RMB2-xx control – see page 34
RMB	Remote Box (available in <i>Designer</i> colors or Gloss finishes) – Non-Standard colors are non-returnable –
TCBI	Thermostatic Control Box with Indicator Lights

Non-Adjustable Tubular Stands

AIH4NTL	4"
AIH6NTL	6"
AIH7.5NTL-D	7.5"
AIH8NTL	8" (Dual models require two pair)
AIH10NTL	10" (Dual models require two pair)
AIH12NTL-D	12"
AIH14NTL-D	14"

NTL-PAINT	<i>Designer</i> color or Gloss finish for Non-Adjustable Tubular Stands – Non-Standard colors are non-returnable –
NTL-PAINT-D	<i>Designer</i> color or Gloss finish for Non-Adjustable Tubular Stands – Non-Standard colors are non-returnable –

Power Leads (must specify lead length) –

HTLEADS5	1'-5' extended Electrical Leads
HTLEADS10	6'-10' extended Electrical Leads
HTLEADS15	11'-15' extended Electrical Leads
HTLEADS20	16'-20' extended Electrical Leads

ACCESSORIES (available for purchase at any time)

ADJ ANGLE	Adjustable Angle Brackets (see page 33 for illustration)
ADJ ANGLE7	7" tall Adjustable Angle Brackets (see page 33 for illustration)
ADJ ANGLE-D	Adjustable Angle Brackets for Dual models (see page 33 for illustration)
ADJ ANGLE7-D	7" tall Adjustable Angle Brackets for Dual models (see page 33 for illustration)
CHAIN 1	Chain Suspension (see page 33 for illustration)

Chef LED 120V adjustable bulb – GRAIHL-xx models only, all voltages – pass-through usage only –

GRAIHL-xx must be 11" or higher from surface as pass through
 Contact your local representative or the factory for up-to-date listing of installations and applicable models
CLED-2700-120 Warm light **CLED-3000-120** Warm light **CLED-4000-120** Cool light



Chef LED Bulb

COLORS AND FINISHES – PAGE 36



Glo-Ray® Designer Infrared Strip Heaters

Hatco Glo-Ray® Designer Infrared Strip Heaters safely keep all hot foods at optimum serving temperatures longer. This modern design is ideal for front-of-the-house use. Units are offered in continuous housings, up to 84" (7'), are available in Designer colors to match most décors and include 14" Designer non-adjustable stands.

- Pre-focused heat maintains safe serving temperatures longer without continuing to cook the food
- Available in widths from 21½" to 87½"
- Available in a variety of models, configurations, colors and accessories to provide unlimited flexibility
- Black corner caps and inset panels Standard

- Optional coated shatter-resistant incandescent or halogen lights enhance product displays while safeguarding food from bulb breakage
- Optional sneeze guards
- Additional reflector styles and lower wattage elements available, consult factory for more information



GR2AH-36 with Designer non-adjustable stands (NTL) and optional Designer color inset panels

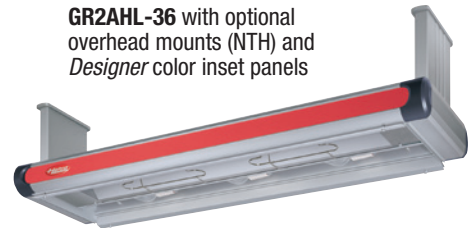

GR2AHL-36 with optional overhead mounts (NTH) and Designer color inset panels

Toggle Switch: Max. 15 Amps
Infinite Switch: Max. 12.2 Amps

DESIGNER INFRARED ALUMINUM STRIP HEATERS

Model [⊙]	Width	Watts	Ship Weight [◇]
Standard Watt			
GR2A-18	21½"	250	28 lbs.
GR2A-24	27½"	350	32 lbs.
GR2A-30	33½"	450	35 lbs.
GR2A-36	39½"	575	37 lbs.
GR2A-42	45½"	675	53 lbs.
GR2A-48	51½"	800	64 lbs.
GR2A-54	57½"	925	74 lbs.
GR2A-60	63½"	1050	82 lbs.
GR2A-66	69½"	1160	91 lbs.
GR2A-72	75½"	1275	100 lbs.
GR2A-84 [▼]	87½"	1500	120 lbs.
High Watt			
GR2AH-18	21½"	350	28 lbs.
GR2AH-24	27½"	500	32 lbs.
GR2AH-30	33½"	660	35 lbs.
GR2AH-36	39½"	800	37 lbs.
GR2AH-42	45½"	950	53 lbs.
GR2AH-48	51½"	1100	64 lbs.
GR2AH-54	57½"	1250	74 lbs.
GR2AH-60	63½"	1400	82 lbs.
GR2AH-66 [▼]	69½"	1560	91 lbs.
GR2AH-72 [▼]	75½"	1725	100 lbs.
GR2AH-84 [▲]	87½"	2050	120 lbs.

• When no color is specified, color inset panels and corner caps will be black.

◇ Does not include Remote Control Box (RMB).

⊙ Does not include Remote Control Box (RMB). Must choose RMB (see pages 34 and 35).

▼ When using an infinite control with 120 volt model, additional switch(es) and tandem (end-to-end) elements required.

▲ 120 volt models require additional switches and tandem (end-to-end) elements.

All Designer Infrared Models Feature:

Voltage: 120, 208 or 240, single phase only.

Switch Location: Remote only (see pages 34 and 35).

Leads: 5' leads through ½" conduit in leg cavity.

Dimensions without stands: 21½"-87½"W x 9"D x 3½"H.

OPTIONS AND ACCESSORIES – PAGE 26

RECOMMENDED MOUNTING HEIGHTS – PAGE 32

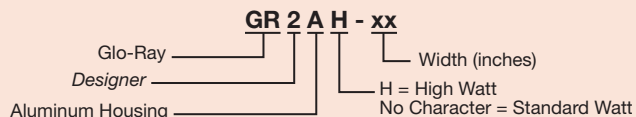

Glo-Ray® Designer Infrared Strip Heaters with Lights

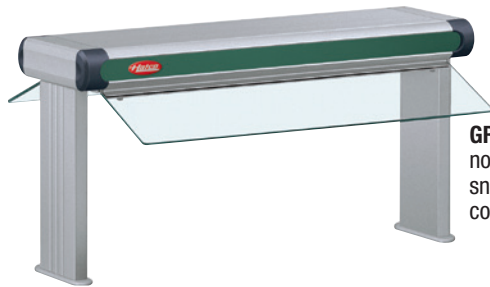

GR2AHL-24 with Designer non-adjustable stands optional sneeze guards and Designer color inset panels

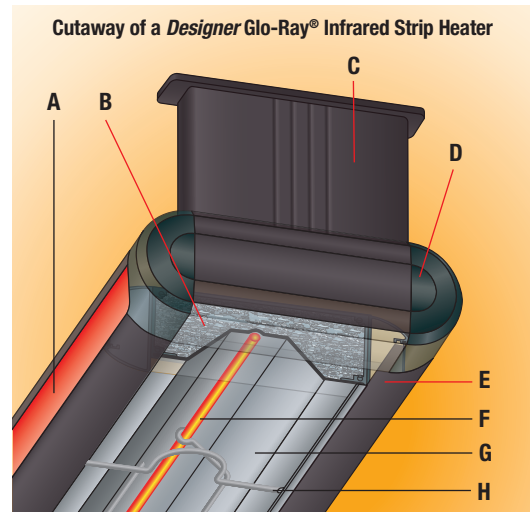

- A** Choice of seven Designer color inset panels and attractive styling for front-of-the-house applications
- B** Heavy-duty insulation minimizes heat loss
- C** Non-adjustable stand conceals the power wiring, available for counter or overhead mounting
- D** Accent color corners available in Dark Gray or Black (Standard)
- E** Sturdy aluminium extrusion construction; available in clear anodized aluminum finish or one of seven Designer colors for housings (shown in optional Designer Black)
- F** Metal-sheathed heating element part guaranteed against burnout and breakage for two years
- G** Aluminized Reflectors won't discolor, so heat can be reflected and directed to the food product being held
- H** Protective wire guard supports heating element without affecting heat distribution

DESIGNER ALUMINUM STRIP HEATERS WITH LIGHTS

Model [Ⓞ]	No. of Bulbs	Width	Watts	Ship Weight [Ⓢ]
Standard Watt				
GR2AL-18	2	21½"	370	28 lbs.
GR2AL-24	2	27½"	470	32 lbs.
GR2AL-30	2	33½"	570	35 lbs.
GR2AL-36	3	39½"	755	37 lbs.
GR2AL-42	3	45½"	855	53 lbs.
GR2AL-48	4	51½"	1040	64 lbs.
GR2AL-54	4	57½"	1165	74 lbs.
GR2AL-60	5	63½"	1350	83 lbs.
GR2AL-66	5	69½"	1460	93 lbs.
GR2AL-72	6	75½"	1635	101 lbs.
GR2AL-84 [▼]	7	87½"	1920	123 lbs.
High Watt				
GR2AHL-18	2	21½"	470	28 lbs.
GR2AHL-24	2	27½"	620	32 lbs.
GR2AHL-30	2	33½"	780	35 lbs.
GR2AHL-36	3	39½"	980	37 lbs.
GR2AHL-42	3	45½"	1130	53 lbs.
GR2AHL-48	4	51½"	1340	64 lbs.
GR2AHL-54	4	57½"	1490	74 lbs.
GR2AHL-60	5	63½"	1700	83 lbs.
GR2AHL-66 [▼]	5	69½"	1860	93 lbs.
GR2AHL-72 [▼]	6	75½"	2085	101 lbs.
GR2AHL-84 [▲]	7	87½"	2470	123 lbs.

- When no color is specified, color inset panels and corner caps will be black.
- Ⓢ Does not include Remote Control Box (RMB).
- Ⓞ Does not include Remote Control Box (RMB). Must choose RMB (see pages 34 and 35).
- ▼ When using an infinite control with 120 volt model, additional switch(es) and tandem (end-to-end) elements required.
- ▲ 120 volt models require additional switches and tandem (end-to-end) elements.

All Designer Infrared Models with Lights Feature:

Voltage: 120, 120/208 or 120/240, single phase only.

Switch Location: Remote only (see pages 34 and 35).

Leads: 5' leads through ½" conduit in leg cavity.

Dimensions without stands: 21½"-87½"W x 12"D x 3½"H.

OPTIONS AND ACCESSORIES – PAGE 26

RECOMMENDED MOUNTING HEIGHTS – PAGE 32

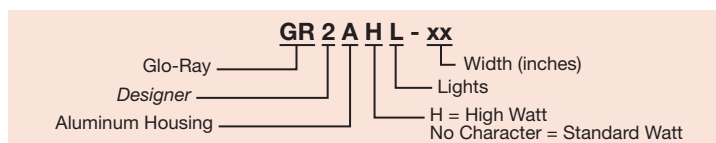



GR2AHL-84 with Standard Designer non-adjustable stands and optional Designer color and sneeze guards

OPTIONS (available at time of purchase only)

Designer colors, aluminum models 21½"- 87½" (includes stands) – Non-Standard colors are non-returnable –

COLOR-6	9" Housing for GR2A and GR2AH models (color selection below)					
COLOR-9	12" Housing for GR2AL and GR2AHL models (color selection below)					

RED	Warm Red	GRAY	Gray Granite	NAVY	Navy Blue	COPPER	Antique Copper
BLACK	Black	WHITE	White Granite	GREEN	Hunter Green		

Designer Inset Panel Colors – Black Standard – Non-Standard colors are non-returnable –

RED	Warm Red	GRAY	Gray Granite	NAVY	Navy Blue	COPPER	Antique Copper
BLACK	Black	WHITE	White Granite	GREEN	Hunter Green		

Designer Corner Caps – Black Standard –

BLACK	Black Corner Caps	DKGRAY	Dark Gray Corner Caps
--------------	-------------------	---------------	-----------------------

NO CONTROL No control included (GR2A, GR2AH, GR2AL, GR2AHL models only), requires selection of RMB2-xx control – see page 34

RMB Must choose Remote Control Enclosure (RMB not included) **see pages 34 and 35**

Designer Remote Control Enclosures – Non-Standard colors are non-returnable –

RMB-COLOR	Remote Control Housing in Designer color						
RED	Warm Red	GRAY	Gray Granite	NAVY	Navy Blue	COPPER	Antique Copper
BLACK	Black	WHITE	White Granite	GREEN	Hunter Green		

7.5BP1 7½" Sneeze Guard one side

7.5BP2 7½" Sneeze Guard two sides

14BP1 14" Sneeze Guard one side

14BP2 14" Sneeze Guard two sides

NTL2-10, -12, -16 Designer color Non-Adjustable Stands to match unit color: 10", 12" or 16" in lieu of 14" Standard Stands – Non-Standard colors are non-returnable –

NTH2-4 4" Designer color Overhead Mounts in lieu of 14" Standard Legs to match unit color – Non-Standard colors are non-returnable –

HAL 60 Watt Halogen Bulb in lieu of Standard Display Light

NO BULB No bulb option (GR2AL, GR2AHL models only)

LIGHTS-ADD'L Extra Lamps – Installed (max. two per ft. less one – one per ft. is Standard)

Power Leads (must specify lead length) –

LEADS5	1'-5' extended Electrical Leads
LEADS10	6'-10' extended Electrical Leads
LEADS15	11'-15' extended Electrical Leads
LEADS20	16'-20' extended Electrical Leads

ACCESSORIES (available for purchase at any time)

Chef LED 120V adjustable bulb – GR2AL, GR2AHL models only, all voltages –

GR2AHL requires pass-through usage only and unit must be 10" or higher from surface
 Contact your local representative or the factory for up-to-date listing of installations and applicable models

CLED-2700-120	Warm light	CLED-3000-120	Warm light	CLED-4000-120	Cool light
----------------------	------------	----------------------	------------	----------------------	------------



Chef LED Bulb

COLORS AND FINISHES – PAGE 36

Glo-Ray® Designer Dual Infrared Strip Heaters

Glo-Ray® Designer Aluminum Dual Infrared Strip Heaters allow side-by-side mounting of two warmers to provide a deeper holding area, keeping hot food at optimum serving temperatures. These modern front-of-the-house warmers have 3" spacers Standard with optional 6" spacers. Units are available in Designer colors to match most décors.

- Sturdy continuous aluminum housings eliminate sagging
- Pre-focused heat pattern directs heat from a tubular element to bathe the entire holding surface, holding food safely
- Available in widths from 21½" to 87½"
- Variety of models, configurations, colors and accessories provide unlimited flexibility. Non-Standard colors are non-returnable

- Optional sneeze guards that meet food safety Standards can be ordered for display areas and buffet lines
- Optional shatter-resistant incandescent lights available
- Black corner caps and inset panels Standard
- Additional reflector styles and lower wattage elements available, consult factory for more information



GR2AH-24D with Standard Designer non-adjustable stands, optional sneeze guards and optional Designer color inset panels

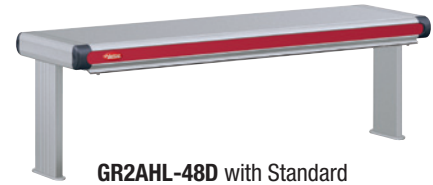

GR2AHL-48D with Standard Designer non-adjustable stands and optional Designer color inset panels

Toggle Switch: Max. 15 Amps
Infinite Switch: Max. 12.2 Amps

DESIGNER DUAL INFRARED ALUMINUM STRIP HEATERS

Model [⊙]	Width	Watts	Ship Weight [◇]
Standard Watt			
GR2A-18D	21½"	500	44 lbs.
GR2A-24D	27½"	700	48 lbs.
GR2A-30D	33½"	900	52 lbs.
GR2A-36D	39½"	1150	57 lbs.
GR2A-42D	45½"	1350	66 lbs.
GR2A-48D	51½"	1600	77 lbs.
GR2A-54D	57½"	1850	88 lbs.
GR2A-60D	63½"	2100	97 lbs.
GR2A-66D	69½"	2320	107 lbs.
GR2A-72D	75½"	2550	117 lbs.
GR2A-84D [■]	87½"	3000	138 lbs.
High Watt			
GR2AH-18D	21½"	700	44 lbs.
GR2AH-24D	27½"	1000	48 lbs.
GR2AH-30D	33½"	1320	52 lbs.
GR2AH-36D	39½"	1600	57 lbs.
GR2AH-42D	45½"	1900	66 lbs.
GR2AH-48D	51½"	2200	77 lbs.
GR2AH-54D	57½"	2500	88 lbs.
GR2AH-60D	63½"	2800	97 lbs.
GR2AH-66D [◆]	69½"	3120	107 lbs.
GR2AH-72D [◆]	75½"	3450	117 lbs.
GR2AH-84D [■]	87½"	4100	138 lbs.

- When no color is specified, color inset panels and corner caps will be black.
- ◇ Does not include Remote Control Box (RMB).
- ⊙ Does not include Remote Control Box (RMB). Must choose RMB, see pages 34, 35.
- ◆ Infinite Switch not available in 120V.
- 120 volt models not available.

All Designer Dual Infrared Aluminum Models Feature:

Voltage: Models Without Lights: 120, 208 or 240, single phase only.
Switch Location: Remote only (see pages 34 and 35).
Leads: 5' leads through ½" conduit in leg cavity.
Dimensions: with 3" Spacer (Standard): 21½"-87½"W x 18"D x 3½"H.
with 6" Spacer: 21½"-87½"W x 21"D x 3½"H.

OPTIONS AND ACCESSORIES – PAGE 28

RECOMMENDED MOUNTING HEIGHTS – PAGE 32

DESIGNER DUAL INFRARED ALUMINUM STRIP HEATERS WITH LIGHTS

Model [⊙]	No. of Bulbs	Width	Watts	Ship Weight [◇]
Standard Watt				
GR2AL-18D	2	21½"	620	44 lbs.
GR2AL-24D	2	27½"	820	48 lbs.
GR2AL-30D	2	33½"	1020	53 lbs.
GR2AL-36D	3	39½"	1330	58 lbs.
GR2AL-42D	3	45½"	1530	67 lbs.
GR2AL-48D	4	51½"	1840	79 lbs.
GR2AL-54D	4	57½"	2090	91 lbs.
GR2AL-60D	5	63½"	2400	100 lbs.
GR2AL-66D	5	69½"	2620	110 lbs.
GR2AL-72D	6	75½"	2910	120 lbs.
GR2AL-84D [■]	7	87½"	3420	141 lbs.
High Watt				
GR2AHL-18D	2	21½"	820	44 lbs.
GR2AHL-24D	2	27½"	1120	48 lbs.
GR2AHL-30D	2	33½"	1440	53 lbs.
GR2AHL-36D	3	39½"	1780	58 lbs.
GR2AHL-42D	3	45½"	2080	67 lbs.
GR2AHL-48D	4	51½"	2440	79 lbs.
GR2AHL-54D	4	57½"	2740	91 lbs.
GR2AHL-60D	5	63½"	3100	100 lbs.
GR2AHL-66D [◆]	5	69½"	3420	110 lbs.
GR2AHL-72D [◆]	6	75½"	3810	120 lbs.
GR2AHL-84D [■]	7	87½"	4520	141 lbs.

- When no color is specified, color inset panels and corner caps will be black.
- ◇ Does not include Remote Control Box (RMB).
- ⊙ Does not include Remote Control Box (RMB). Must choose RMB, see pages 34, 35.
- ◆ Infinite Switch not available in 120V.
- 120 volt models not available.

All Designer Dual Aluminum Models with Lights Feature:

Voltage: Models With Lights: 120, 120/208 or 120/240, single phase only.
Switch Location: Remote only (see pages 34 and 35).
Leads: 5' leads through ½" conduit in leg cavity.
Dimensions: with 3" Spacer (Standard): 21½"-87½"W x 18"D x 3½"H.
with 6" Spacer: 21½"-87½"W x 21"D x 3½"H.

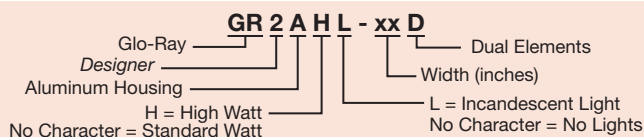



GR2AHL-30D

OPTIONS (available at time of purchase only)

Designer colors, aluminum models 21½" - 87½" (includes stands) – Non-Standard colors are non-returnable –
COLOR-15, -18 15" and 18" Housings for GR2A, GR2AH, GR2AL and GR2AHL Dual models

RED	Warm Red	GRAY	Gray Granite	NAVY	Navy Blue	COPPER	Antique Copper
BLACK	Black	WHITE	White Granite	GREEN	Hunter Green		

Designer Inset Panel Colors – Black Standard –

RED	Warm Red	GRAY	Gray Granite	NAVY	Navy Blue	COPPER	Antique Copper
BLACK	Black	WHITE	White Granite	GREEN	Hunter Green		

Designer Corner Caps – Black Standard –

BLACK	Black Corner Caps	DKGRAY	Dark Gray Corner Caps
--------------	-------------------	---------------	-----------------------

NO CONTROLS No control included (GR2A, GR2AH, GR2AL, GR2AHL-xxD models only), requires selection of RMB2-xx control – see page 34

RMB Remote Box (available in *Designer* colors or Gloss finishes) – Non-Standard colors are non-returnable – (must choose Remote Control Enclosure - RMB not included) **see pages 34 and 35**

Designer Remote Control Enclosures – Non-Standard colors are non-returnable –

RMB-COLOR	Remote Control Housing in <i>Designer</i> color						
RED	Warm Red	GRAY	Gray Granite	NAVY	Navy Blue	COPPER	Antique Copper
BLACK	Black	WHITE	White Granite	GREEN	Hunter Green		

7.5BP1 7½" Sneeze Guard one side

7.5BP2 7½" Sneeze Guard two sides

14BP1 14" Sneeze Guard one side

14BP2 14" Sneeze Guard two sides

NTL2-10, -12, -16 *Designer* Non-Adjustable Stands: 10", 12" or 16" in lieu of 14" Standard Stands – Non-Standard colors are non-returnable –

NTH2-4 4" *Designer* Overhead Mounts in lieu of 14" Standard Stands – Non-Standard colors are non-returnable –

HAL 60 Watt Halogen Bulb in lieu of Standard Display Light

NO BULB No bulb option (GR2AL-xxD, GR2AHL-xxD models only)

LIGHTS-ADD'L Extra Lamps – Installed (max. two per ft. less one – one per ft. is Standard)

Power Leads (must specify lead length) –

LEADS5	1'-5' extended Electrical Leads
LEADS10	6'-10' extended Electrical Leads
LEADS15	11'-15' extended Electrical Leads
LEADS20	16'-20' extended Electrical Leads

ACCESSORIES (available for purchase at any time)

Chef LED 120V adjustable bulb – GR2AL-xxD, GR2AHL-xxD models only, all voltages –

GR2AL-xxD requires pass-through usage only and unit must be 15" or higher from surface

GR2AHL-xxD requires pass-through usage only and unit must be 18" or higher from surface

Contact your local representative or the factory for up-to-date listing of installations and applicable models

CLED-2700-120	Warm light	CLED-3000-120	Warm light	CLED-4000-120	Cool light
----------------------	------------	----------------------	------------	----------------------	------------



Chef LED Bulb

COLORS AND FINISHES – PAGE 36

Ultra-Glo® Ceramic Infrared Aluminum Strip Heaters

Hatco Ultra-Glo® Ceramic Strip Heaters provide the ultimate holding power. Increased heights improve working clearances and the heat zone blankets the entire holding area. All models include adjustable angle brackets for mounting. Available with or without lights, with Attached or Remote Control Box Enclosure (recommended).



UGAH-18 in optional Gloss finish, requires Remote Control Enclosure (RMB), not shown

- Pre-focused pyramidal heat pattern concentrates the heat at the edges where heat loss is greatest
- Increased height that the ceramic heat source affords improves operational working clearances, giving the chef and server an improved ergonomic environment in which to work
- Adaptable to many locations and configurations, including back- or front-of-the-house use, open kitchen concepts or buffet lines
- Available in widths from 18" to 72" in 6" increments
- Optional coated shatter-resistant incandescent or halogen bulbs enhance product display while safeguarding food from bulb breakage

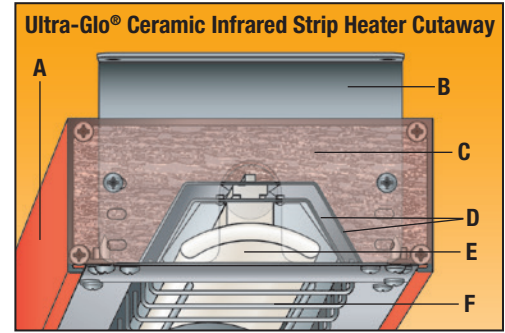

- A** Sturdy aluminum housings that do not sag
- B** Adjustable Standard mounting bracket (allows 3 different mounting heights and allows for conduit connection to end of the unit)
- C** Heavy-duty insulation surrounds heating element to keep exterior housing cooler and minimize heat loss
- D** Dual aluminized steel reflector keeps housing cooler, focuses more heat towards the food
- E** Shape of element focuses heat on the food
- F** Protective wire guards under heating element

ULTRA-GLO® CERAMIC INFRARED ALUMINUM STRIP HEATERS

Model +	Width	Voltage		Watts	Ship Weight †
		Single Phase			
Standard Watt					
UGA-18	18"	120, 208 or 240		500, 490 or 500	9 lbs.
UGA-24	24"	120, 208 or 240		650, 675 or 650	10 lbs.
UGA-30	30"	120, 208 or 240		750, 840 or 900	11 lbs.
UGA-36	36"	120, 208 or 240		1000, 980 or 1000	12 lbs.
UGA-42	42"	120, 208 or 240		1000, 1120 or 1200	13 lbs.
UGA-48	48"	120, 208 or 240		1500, 1470 or 1500	14 lbs.
UGA-54	54"	208 or 240		1470 or 1500	16 lbs.
UGA-60	60"	208 or 240		1960 or 2000	17 lbs.
UGA-66	66"	208 or 240		1960 or 2000	19 lbs.
UGA-72	72"	208 or 240		1960 or 2000	20 lbs.

High Watt					
Model +	Width	Single Phase		Watts	Ship Weight †
UGAH-18	18"	120, 208 or 240		650, 675 or 650	9 lbs.
UGAH-24	24"	120, 208 or 240		750, 750 or 750	10 lbs.
UGAH-30	30"	120, 208 or 240		1125, 1125 or 1125	11 lbs.
UGAH-36	36"	120, 208 or 240		1300, 1350 or 1300	12 lbs.
UGAH-42	42"	120, 208 or 240		1500, 1500 or 1500	13 lbs.
UGAH-48	48"	208 or 240		2025 or 1950	14 lbs.
UGAH-54	54"	208 or 240		2250 or 2250	16 lbs.
UGAH-60	60"	208 or 240		2700 or 2600	17 lbs.
UGAH-66	66"	208 or 240		2700 or 2600	19 lbs.
UGAH-72	72"	208 or 240		3000 or 3000	20 lbs.

All Ultra-Glo® Ceramic Infrared Aluminum Models Feature:
Models Shipped With: Angle Brackets and Leads (3' conduit whip).
Dimensions With Attached Control Box, Toggle and Indicator Light:
 18"-72"W x 9 1/8"D x 2 1/2"H.
Dimensions With Remote Control Enclosure, Toggle and Indicator Light:
 18"-72"W x 6"D x 2 1/2"H.

OPTIONS AND REMOTE BOXES (RMB) – PAGE 31
RECOMMENDED MOUNTING HEIGHTS – PAGE 32

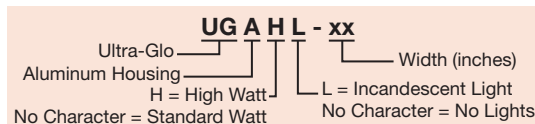

ULTRA-GLO® CERAMIC INFRARED ALUMINUM STRIP HEATERS WITH LIGHTS

Model +	No. of Bulbs	Width	Voltage		Watts	Ship Weight †
			Single Phase			
Standard Watt						
UGAL-18	1	18"	120, 120/208 or 120/240		560, 550 or 560	12 lbs.
UGAL-24	2	24"	120, 120/208 or 120/240		770, 795 or 770	13 lbs.
UGAL-30	2	30"	120, 120/208 or 120/240		870, 960 or 1020	15 lbs.
UGAL-36	3	36"	120, 120/208 or 120/240		1180, 1160 or 1180	17 lbs.
UGAL-42	3	42"	120, 120/208 or 120/240		1380, 1300 or 1380	18 lbs.
UGAL-48	4	48"	120, 120/208 or 120/240		1740, 1710 or 1740	20 lbs.
UGAL-54	4	54"	120/208 or 120/240		1710 or 1740	22 lbs.
UGAL-60	5	60"	120/208 or 120/240		2260 or 2300	23 lbs.
UGAL-66	5	66"	120/208 or 120/240		2260 or 2300	25 lbs.
UGAL-72	6	72"	120/208 or 120/240		2320 or 2360	27 lbs.

High Watt						
Model +	No. of Bulbs	Width	Single Phase		Watts	Ship Weight †
UGAHL-18	1	18"	120, 120/208 or 120/240		710, 735, or 710	12 lbs.
UGAHL-24	2	24"	120, 120/208 or 120/240		870, 870 or 870	13 lbs.
UGAHL-30	2	30"	120, 120/208 or 120/240		1245, 1245 or 1245	15 lbs.
UGAHL-36	3	36"	120, 120/208 or 120/240		1480, 1530 or 1480	17 lbs.
UGAHL-42	3	42"	120, 120/208 or 120/240		1680, 1680 or 1680	18 lbs.
UGAHL-48	4	48"	120/208 or 120/240		2265 or 2190	20 lbs.
UGAHL-54	4	54"	120/208 or 120/240		2490 or 2490	22 lbs.
UGAHL-60*	5	60"	120/208 or 120/240		3000 or 2900	23 lbs.
UGAHL-66*	5	66"	120/208 or 120/240		3000 or 2900	25 lbs.
UGAHL-72*	6	72"	120/208 or 120/240		3360 or 3360	27 lbs.

‡ Does not include Remote Control Enclosure (RMB).
 † Includes either Attached Control or Remote Control Enclosure (RMB) with toggle switch(es) and indicator light(s).
 * UGAHL-60, -66, -72 in 120/208 and UGAHL-72 in 120/240 require Remote Control Enclosure (RMB) with a Fuse.

All Ultra-Glo® Aluminum Ceramic Infrared Models with Lights Feature:
Models Shipped With: Angle Brackets and Leads (3' conduit whip).
Dimensions With Attached Control Box, Toggle and Indicator Light:
 18"-72"W x 12 1/8"D x 2 1/2"H.
Dimensions With Remote Control Enclosure, Toggle and Indicator Light:
 18"-72"W x 9"D x 2 1/2"H.

OPTIONS AND REMOTE BOXES (RMB) – PAGE 31
RECOMMENDED MOUNTING HEIGHTS – PAGE 32



Ultra-Glo® Dual Ceramic Infrared Aluminum Strip Heaters

Hatco Ultra-Glo® Ceramic Strip Heaters provide the ultimate holding power. Increased height improves working clearances and the heat zone blankets the entire holding area. All models include adjustable angle brackets for mounting. Dual mounted strip heaters accommodate wider food holding areas.

- Increased height improves operational working clearances, giving chef and server an improved ergonomic environment in which to work
- Adaptable to any location and configuration, including back- or front-of-the-house use, open kitchen concepts or buffet lines
- Pre-focused heat pattern provides an increased pyramidal dimension, concentrating heat at the edges where heat loss is the greatest

- Available in widths from 18" to 72"
- Remote Control Enclosure with toggle switch, indicator light and wiring for convenient control placement
- Sturdy extruded aluminum housings eliminate sagging

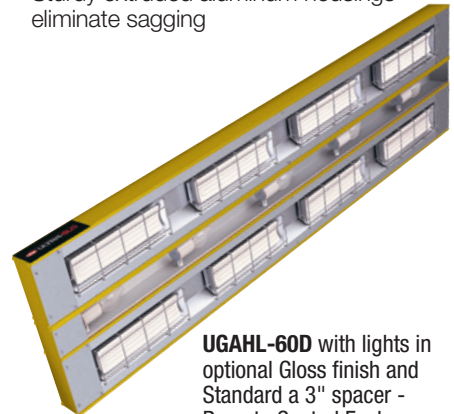

UGAHL-60D with lights in optional Gloss finish and Standard a 3" spacer - Remote Control Enclosure (RBM) required, not shown

ULTRA-GLO® DUAL CERAMIC INFRARED ALUMINUM STRIP HEATERS

Model ⁺	Width	Voltage Single Phase	Watts	Ship Weight [◇]
Standard Watt				
UGA-18D	18"	120, 208 or 240	1000, 980 or 1000	17 lbs.
UGA-24D	24"	120, 208 or 240	1300, 1350 or 1300	19 lbs.
UGA-30D	30"	120, 208 or 240	1500, 1680 or 1800	21 lbs.
UGA-36D	36"	208 or 240	1960 or 2000	24 lbs.
UGA-42D	42"	208 or 240	2240 or 2400	27 lbs.
UGA-48D	48"	208 or 240	2940 or 3000	30 lbs.
UGA-54D	54"	208 or 240	2940 or 3000	33 lbs.
UGA-60D	60"	208 or 240	3920 or 4000	37 lbs.
UGA-66D	66"	208 or 240	3920 or 4000	40 lbs.
UGA-72D	72"	208 or 240	3920 or 4000	44 lbs.
High Watt				
UGAH-18D	18"	120, 208 or 240	1300, 1350 or 1300	17 lbs.
UGAH-24D	24"	120, 208 or 240	1500, 1500 or 1500	19 lbs.
UGAH-30D	30"	208 or 240	2250, 2250	21 lbs.
UGAH-36D	36"	208 or 240	2700 or 2600	24 lbs.
UGAH-42D	42"	208 or 240	3000 or 3000	27 lbs.
UGAH-48D	48"	208 or 240	4050 or 3900	30 lbs.
UGAH-54D	54"	208 or 240	4500 or 4500	33 lbs.
UGAH-60D	60"	208 or 240	5400 or 5200	37 lbs.
UGAH-66D	66"	208 or 240	5400 or 5200	40 lbs.
UGAH-72D	72"	208 or 240	6000 or 6000	44 lbs.

ULTRA-GLO® DUAL CERAMIC INFRARED ALUMINUM STRIP HEATERS WITH LIGHTS

Model ⁺	No. of Bulbs	Width	Voltage Single Phase	Watts	Ship Weight [◇]
Standard Watt					
UGAL-18D	1	18"	120, 120/208 or 120/240	1060, 1040 or 1060	17 lbs.
UGAL-24D	2	24"	120, 120/208 or 120/240	1420, 1470 or 1420	19 lbs.
UGAL-30D	2	30"	120, 120/208 or 120/240	1620, 1800 or 1920	21 lbs.
UGAL-36D	3	36"	120/208 or 120/240	2140 or 2180	24 lbs.
UGAL-42D	3	42"	120/208 or 120/240	2420 or 2580	27 lbs.
UGAL-48D	4	48"	120/208 or 120/240	3180 or 3240	30 lbs.
UGAL-54D	4	54"	120/208 or 120/240	3180 or 3240	33 lbs.
UGAL-60D	5	60"	120/208 or 120/240	4220 or 4300	37 lbs.
UGAL-66D	5	66"	120/208 or 120/240	4220 or 4300	40 lbs.
UGAL-72D	6	72"	120/208 or 120/240	4280 or 4360	44 lbs.
High Watt					
UGAHL-18D	1	18"	120, 120/208 or 120/240	1360, 1410 or 1360	17 lbs.
UGAHL-24D	2	24"	120, 120/208 or 120/240	1620, 1620 or 1620	19 lbs.
UGAHL-30D	2	30"	120/208 or 120/240	2370 or 2370	21 lbs.
UGAHL-36D	3	36"	120/208 or 120/240	2880 or 2780	24 lbs.
UGAHL-42D	3	42"	120/208 or 120/240	3180 or 3180	27 lbs.
UGAHL-48D	4	48"	120/208 or 120/240	4290 or 4140	30 lbs.
UGAHL-54D	4	54"	120/208 or 120/240	4740 or 4740	33 lbs.
UGAHL-60D	5	60"	120/208 or 120/240	5700 or 5500	37 lbs.
UGAHL-66D	5	66"	120/208 or 120/240	5700 or 5500	40 lbs.
UGAHL-72D	6	72"	120/208 or 120/240	6360 or 6360	44 lbs.

◇ Does not include Remote Control Box (RMB).

+ Includes either Attached Control or Remote Control Enclosure (RMB) with toggle switch(es) and indicator light(s).

All Ultra-Glo® Dual Ceramic Infrared Aluminum Models Feature:

Models Shipped With: Angle brackets and leads (3' conduit whip).
 Dimensions With Attached Control Box, Toggle and Indicator Light: 18" - 72"W x 18 1/8" or 21 1/8"D x 2 1/2"H.
 Dimensions With Remote Control Enclosure, Toggle and Indicator Light: 18" - 72"W x 15" or 18"D x 2 1/2"H.

OPTIONS AND REMOTE BOXES (RMB) – PAGE 31
RECOMMENDED MOUNTING HEIGHTS – PAGE 32

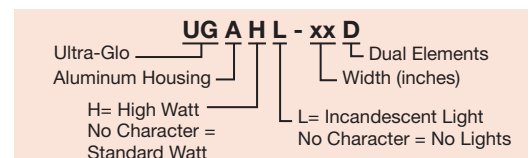



UGAH-36D with Standard 3" spacer, Remote Control Enclosure (RMB) recommended - not shown

OPTIONS (available at time of purchase only)

Designer colors, aluminum models 18"-72" – Non-Standard colors are non-returnable –

COLOR-6	6" Housing for Single UGA and UGAH models, 18" - 72" (color selections below)					
COLOR-9	9" Housing for Single UGAL and UGAHL models, 18" - 72" (color selections below)					
COLOR-15, -18	15" and 18" Housings for Dual UGA, UGAH, UGAL, UGAHL models, 18" - 72" (color selections below)					
	RED Warm Red	GRAY Gray Granite	NAVY Navy Blue	COPPER Antique Copper		
	BLACK Black	WHITE White Granite	GREEN Hunter Green			

Gloss finishes, aluminum models 18"- 72" – Non-Standard colors are non-returnable –

GLOSS-6	6" Housing for Single UGA and UGAH models, 18" - 72" (finish selections below)					
GLOSS-9	9" Housing for Single UGAL and UGAHL models, 18" - 72" (finish selections below)					
GLOSS-15, -18	15" and 18" Housings for Dual UGA, UGAH, UGAL, UGAHL models, 18" - 72" (finish selections below)					
	RRED Radiant Red	GGRAY Glossy Gray	BBLACK Bold Black			
	GGOLD Gleaming Gold	BBLUE Brilliant Blue				

Designer colors for Remote Control Enclosures – Non-Standard colors are non-returnable –

RMB-COLOR	Remote Control Housing in <i>Designer</i> colors					
	RED Warm Red	GRAY Gray Granite	NAVY Navy Blue	COPPER Antique Copper		
	BLACK Black	WHITE White Granite	GREEN Hunter Green			

Gloss finishes for Remote Control Enclosures – Non-Standard colors are non-returnable –

RMB-GLOSS	Remote Control Housing in Gloss finish					
	RRED Radiant Red	GGRAY Glossy Gray	BBLACK Bold Black			
	GGOLD Gleaming Gold	BBLUE Brilliant Blue				

HAL	60 Watt Halogen Bulb in lieu of Standard Display Light
LIGHTS ADD'L	Extra Lamps – Installed (max. two per ft. less one, one per ft. is Standard) – not available for Dual models
UGA-NTL-14, -16	Non-Adjustable Tubular Stands – specify 14" or 16" clearance
UGA-NTL-18, -20	Non-Adjustable Tubular Stands – specify 18" or 20" clearance
UGA-NTL-22	Non-Adjustable Tubular Stands for 22" clearance
UGA-NTL-18-D, -20-D	Non-Adjustable Tubular Stands – specify 18" or 20" clearance
UGA-NTL-22-D, -24-D, -26-D	Non-Adjustable Tubular Stands – specify 22", 24" or 26" clearance
NTL-PAINT	<i>Designer</i> colors or Gloss finishes for Non-Adjustable Tubular Stands – Non-Standard colors are non-returnable –
NTL-PAINT-D	<i>Designer</i> colors or Gloss finishes for Non-Adjustable Tubular Stands – Non-Standard colors are non-returnable –

Power Leads – must specify lead length –

HTLEADS5	1'-5' extended Electrical Leads
HTLEADS10	6'-10' extended Electrical Leads
HTLEADS15	11'-15' extended Electrical Leads
HTLEADS20	16'-20' extended Electrical Leads

RMB-UGA Remote Control Enclosure with Toggle Control and Indicator in lieu of attached control box – *Designer* colors and Gloss finishes available

RMB-UGA-INF Remote Control Enclosure with Toggle Switch, Electronic Infinite Control, Relay and Indicator Light in lieu of attached control box – *Designer* colors and Gloss finishes available

COLORS AND FINISHES – PAGE 36

RMB-UGA-INF





Strip Heater Recommended Range Above Target* and Spacing Requirements (based on 24" strip heaters, non-flammable surface)

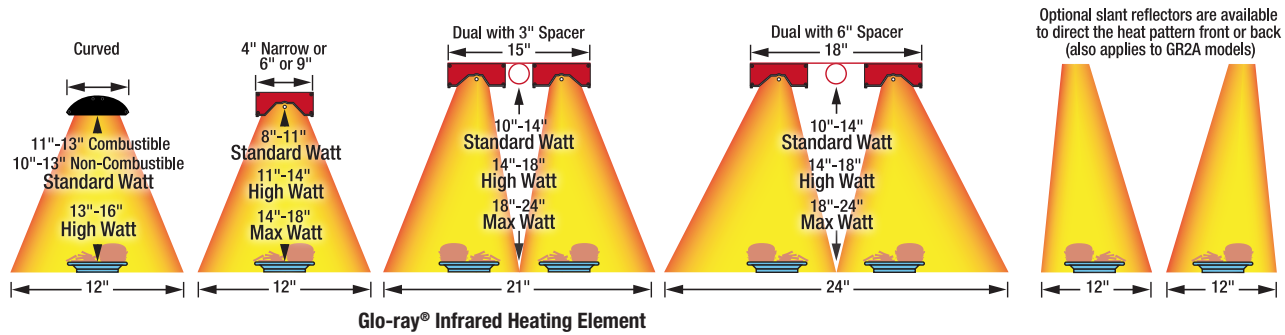

GLO-RAY® INFRARED

Curved Standard Watt (GR5A, GR5AL)

Minimum Combustible: Surface: Install minimum of 1" from back wall, 1" from overshelf and 11" above surface. Minimum Non-Combustible Surface: 1" from overshelf and 10" above surface (back of wall: no requirement).

Curved High Watt (GR5AH, GR5AHL)

Non-combustible surroundings only. Install 1" from overshelf and minimum of 13" above a non-combustible countertop surface (back of wall: no requirement).

Singles (GRA, GRAL, GRAH, GRAHL, GRN)

Singles Designer (GR2A, GR2AH, GR2AL, GR2AHL)

Combustibles: 13½" high watt or 10" Standard watt below, 1" above and 3" to back wall. Non-combustibles: 1" above, 10" below for high watt with infinite or indicator lamp and 8" below for high watt toggle or Standard watt. Must be installed in a pass-through area. Units with remote switches may be installed against a non-combustible back wall, flush to an overshelf and 8" to a surface below. Maximum 10" setback from the front of an overshelf. Models with cords must be installed 3" below an overshelf and 11" high watt or 10" Standard watt over a surface below.

Duals (GRA-D, GRAH-D, GRAL-D, GRAHL-D)

Duals Designer (GR2A-D, GR2AH-D, GR2AL-D, GR2AHL-D)

May not be installed in combustible surroundings. Non-combustibles: 1" above, 10" below. Must be installed in a pass-through area. Units with remote switches may be installed 3" from a non-combustible back wall, 8" from surface below and flush to an overshelf. Maximum 10" setback from the front of an overshelf.

Singles Max-Watt (GRAM, GRAML, GRNM)

Do not use in combustible surroundings. Non-combustibles: 1" above, 12" to surface and 3" from back wall. Cord connected: 3" below an overshelf, 12" from surface below. Max. 10" setback from front of an overshelf.

Duals Max-Watt (GRAM-D, GRAML-D)

May not be installed in combustible surroundings. Non-combustibles: units may be installed 3" from a non-combustible back wall, 1" below an overshelf, 15" to surface below. Maximum 10" setback from the front of an overshelf.

ULTRA-GLO®

Singles and Duals (UGA, UGA-D, UGAH, UGAH-D, UGAL, UGAL-D, UGAHL, UGAHL-D)

May not be installed in combustible surroundings. Non-combustibles: 1" above, 17" high watt or 14" Standard watt from a surface below and 3" from a back wall.

Dual Mounting Do not mount warmers side by side (dual mounting) with less than a 3" space between units.

GLO-RAY® INFRA-BLACK®

Singles (GRAIH, GRAIHL, GRAIHL-D, GRAIH-D)

May not be installed in combustible surroundings. Non-combustibles: 1" above and 4" below. Must be installed in a pass-through area. Units with remote switches may be installed 3" from a non-combustible back wall and flush to an overshelf. Maximum 10" setback from the front of an overshelf.

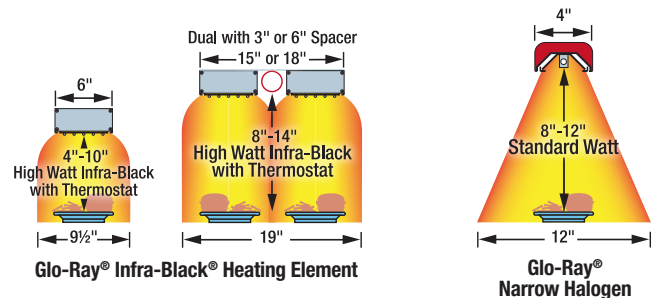
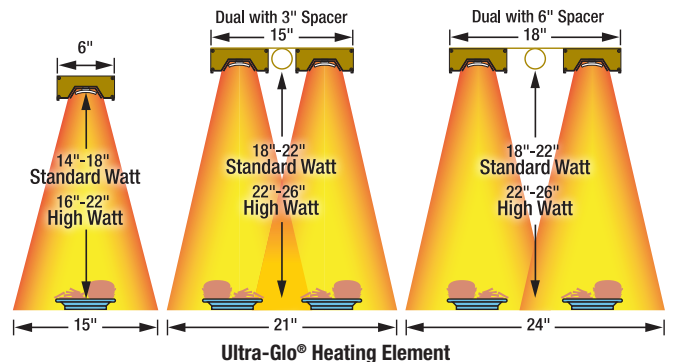
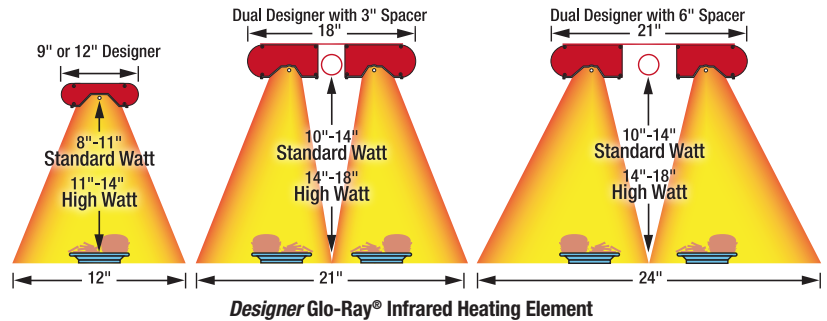

GLO-RAY® NARROW HALOGEN

Singles (GRN4, GRN4L)

Combustibles: Minimum of 10" above surface and 2" from a back wall. Non-combustibles: 7" above and 2" from a back wall.

* Recommended single unit application without base heat, based on ideal conditions. Based on a 24" Strip Heater. Individual applications may vary, consult factory. Non-flammable surface only.

Glo-Ray® Mounting Arrangements

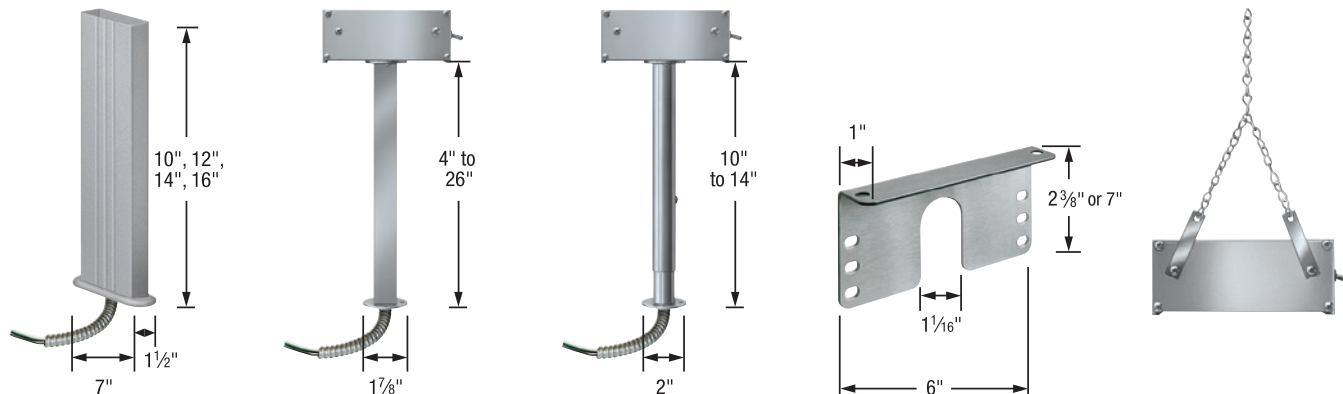

PERMANENT - For hard wired installation

Designer Non-Adjustable Stands

(GR2A series only) Sturdy stands conceal all hook-up wiring. Available in Designer colors.

Non-Adjustable Tubular Stands

Sturdy stands conceal all hook-up wiring. Available in Designer colors. Duals require two pair. Specify power location.

Adjustable Tubular Stands

Sturdy tubular stands conceal all hook-up wiring. Duals require two pair (not available on Max Watt or Ultra-Glo models). Specify power location.

Angle brackets

Special adjustable angle brackets fit 6" or 9" housings for mounting Glo-Ray under a shelf. Provides 1"-2" space or 1"-6" space between Glo-Ray and overshef. Duals require two pair. (Standard on Max Watt or Ultra-Glo models).

Chain Suspension

Chains attach to tabs provided with warmers and are available in various lengths to suit the location (not available on Max Watt or Ultra-Glo models).

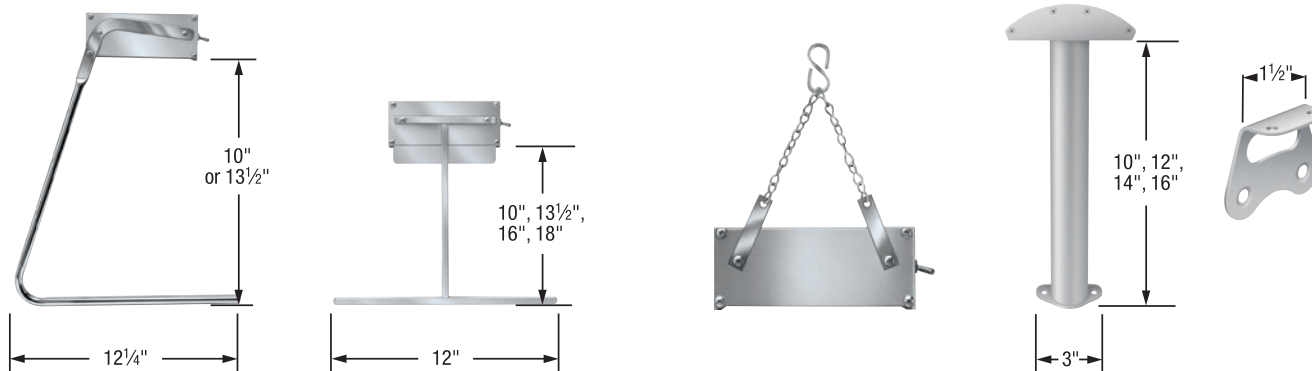

PORTABLE - For cord and plug installation

C-Leg Stands

Attractive chrome plated legs allow easy relocation of the warmer. For models 72" or less in width (not available on Max Watt or Ultra-Glo models). Requires attached cord and plug.

T-Leg Stands

Provide rigid stability and allow for more pass-through area below unit. For models 72" or less in width (not available on Max Watt or Ultra-Glo models). Requires attached cord and plug.

STATIONARY - for cord and plug installation

Chain Hook

Chains attach to tabs provided with warmers. 6" chain with S-Hooks for units with cord and plug only.

GR5A, GR5AH, GR5AL, GR5AHL MOUNTING only

Non-Adjustable Tubular Stands and Angle Brackets

Sturdy stands conceal all hook-up wiring. Specify power location. Standard angle brackets for mounting under a shelf. Provides 1" space between Strip Heater and overshef. End panels and brackets match unit color.



Remote Control Enclosures

1. Find the volt and current (Amp) rating for the Strip Heater(s) the RMB2 will be controlling. This is the total current of all circuits on the warmer(s).
2. If the current rating is under 20 Amps, then select an RMB2-1R, if the current rating is between 20 and 40 Amps, select the RMB2-2R. The RMB2-2R has two 20 Amp outputs.
3. Select the current (Amp) rating of the RMB2 that is just above the total current rating of the warmer(s) it will control. The RMB2 will need to be connected to a branch circuit breaker suitable for its current rating.
4. Select the voltage rating for the RMB2 based on the highest voltage rating of the warmer(s). For example, if the warmer(s) is rated 120/208 volts, select a 208 volt RMB2 control.

- Easy to specify, install and service
- Compatible with most Strip Heaters (GR, GRA, GRAH, GRAIH, GR2A, GR2AH, GR5A, GRN and GRNH series)
- Total amperage of light and heat combined cannot exceed max Amp rating of the control box
- Maximum of 8 Amps total allowed on the light circuit
- Multiple Strip Heaters may be connected to one RMB2 if the combined current draw of the warmers is less than the rating of the RMB2. All warmers will be controlled with same set-point



Choose Remote Box (RMB) can be found on:
www.hatcocorp.com
 under Resources



RMB2-2R
with two relays



RMB2-1R
with one relay

REMOTE CONTROL ENCLOSURES (RMB)

Model	Description	Voltage
RMB2		
1 Toggle, 1 Infinite, 1 Relay, 1 Indicator		
RMB2-1R	12 Max. Amps	120, 208, 240
	16 Max. Amps	120, 208, 240
	20 Max. Amps	120, 208, 240
1 Toggle, 1 Infinite, 2 Relays, 1 Indicator		
RMB2-2R	24 Max. Amps	120, 208, 240
	32 Max. Amps	120, 208, 240
	40 Max. Amps	120, 208, 240

All Models Feature:

Ship Weight: 6-8 lbs. depending on components.

Dimensions: RMB2-1R: 11"W x 4½"D x 5½"H.

RMB2-2R: 14"W x 4½"D x 5½"H.

Cutout Dimensions: RMB2-1R: 10⅞" W x 4¾" H.

RMB2-2R: 13⅞" W x 4¾" H.

Remote Control Enclosures (RMB)

Hatco Remote Control Enclosures are built in accordance with UL Standards for toggle or infinite switches, indicator lights and wiring, ready for installation when purchased with Glo-Ray® Strip Heaters. When Remote Control Enclosures are used, no more than one RMB per Strip Heater and no more than one Strip Heater per RMB.

- Built for toggle or infinite switches, indicator lights and wiring
- One RMB per Strip Heater
- Consult RMB configurator for specific details at www.hatcocorp.com, under "Resources"

RMB-7L with toggle switch and infinite control



RMB-16E with infinite controls, toggle switches and optional *Designer* color



RMB-14E with infinite controls



RMB-3F with toggle switch and indicator light

RMB-7D with toggle switches and optional *Designer* color



REMOTE CONTROL ENCLOSURES (RMB)

Model	Description	Voltage	Width
RMB-3A, -3B, -3C	1 Infinite	120, 208, 240	5½"
RMB-3D	1 Toggle	120, 208, 240	5½"
RMB-3E	2 Toggle	120, 208, 240	5½"
RMB-3F, -3G, -3H	1 Toggle, 1 Indicator	120, 208, 240	5½"
RMB-7A, -7B, -7C	2 Infinite	120, 208, 240	9"
RMB-7D	3 Toggle	120, 208, 240	9"
RMB-7E	4 Toggle	120, 208, 240	9"
RMB-7F, -7G, -7H	1 Infinite, 1 Indicator	120, 208, 240	9"
RMB-7I, -7J, -7K	2 Toggle, 2 Indicator	120, 208, 240	9"
RMB-7L, -7M, -7N	1 Toggle, 1 Infinite	120, 208, 240	9"
RMB-7O, -7P, -7Q	1 Toggle, 1 Infinite, 1 Indicator	120, 208, 240	9"
RMB-7S	2 Toggles, 1 Indicator	120, 208, 240	9"
RMB-14A, -14B, -14C	3 Infinite	120, 208, 240	14"
RMB-14D, -14E, -14F	4 Infinite	120, 208, 240	14"
RMB-14G	5 Toggle	120, 208, 240	14"
RMB-14H	6 Toggle	120, 208, 240	14"
RMB-14I, -14J, -14K	3 Toggle, 3 Indicator	120, 208, 240	14"
RMB-14L, -14M, -14N	2 Infinite, 2 Indicator	120, 208, 240	14"
RMB-14O, -14P, -14Q	2 Toggle, 2 Infinite	120, 208, 240	14"
RMB-14R, -14S, -14T	1 Toggle, 1 Infinite w/Relay, 1 Indicator	120, 208, 240	14"
RMB-14V, -14W, -14Y	1 Toggle, 2 Infinite	120, 208, 240	14"
RMB-14AA, -14AB	Master Toggle, 1 Electronic Infinite w/Relay	120, 208, 240	14"
RMB-14AF, -14AG, -14AH	3 Toggle, 2 Indicator	120, 208, 240	14"
RMB-14AI, -14AJ, -14AK	1 Toggle, 3 Infinite	120, 208, 240	14"
RMB-14AL, -14AM, -14AN	1 Toggle, 2 Infinite, 2 Indicator	120, 208, 240	14"
RMB-14AO, -14AP, -14AQ	1 Toggle, 2 Infinite, 3 Indicator	120, 208, 240	14"
RMB-14AR, -14AS, -14AT	1 Infinite with Relay, 1 Indicator	120, 208, 240	14"
RMB-16B, -16C, -16D	1 Toggle, 4 Infinite	120, 208, 240	16"
RMB-16E, -16F, -16G	3 Toggle, 2 Infinite	120, 208, 240	16"
RMB-20D, -20E, -20F	3 Toggle, 2 Infinite	120, 208, 240	20"
RMB-20G, -20H, -20I	2 Toggle, 4 Infinite	120, 208, 240	20"
RMB-20L, -20J, -20K	3 Toggle, 4 Infinite, 4 Indicator	120, 208, 240	20"
RMB-20M, -20N, -20P	3 Toggle, 2 Infinite, 2 Indicator	120, 208, 240	20"
RMB-20R, -20S, -20T	2 Toggle, 4 Infinite, 4 Indicator	120, 208, 240	20"
RMB-20AA, -20AB, -20AC	2 Toggle, 2 Infinite, 2 Indicator	120, 208, 240	20"
RMB-20AH, -20AF, -20AG	4 Infinite, 4 Indicator	120, 208, 240	20"
RMB-20AN, -20AO, -20AP	4 Toggle, 4 Indicator	120, 208, 240	20"

All Models Feature:

Ship Weight: 2-8 lbs. depending on components.

Max. Allowable Amperage per Switch: Toggle 15.0; Infinite 12.2.

Dimensions (not including switches): 5½", 9", 14", 16" or 20"W x 3"D x 2½"H.

Toggle Switch: Max. 15 Amps
Infinite Switch: Max. 12.2 Amps

Remote Control Enclosures: When used, no more than one RMB per Strip Heater and no more than one Strip Heater per RMB.

Choose Remote Box (RMB) can be found on:
www.hatcocorp.com
under Resources

OPTIONS (available at time of purchase only)

Designer colors – Non-Standard colors are non-returnable –

RMB-COLOR Remote Control Housing in <i>Designer</i> color					
RED	Warm Red	GRAY	Gray Granite	NAVY	Navy Blue
BLACK	Black	WHITE	White Granite	GREEN	Hunter Green
				COPPER	Antique Copper

Gloss finishes – Non-Standard colors are non-returnable –

RMB-GLOSS Remote Control Housing in Gloss finish					
RRED	Radiant Red	GGRAY	Glossy Gray	BBLACK	Bold Black
GGOLD	Gleaming Gold	BBLUE	Brilliant Blue		

COLORS AND FINISHES – PAGE 36



Paint Chip Sample Colors

DESIGNER COLORS



GLOSS FINISHES



PLATED FINISHES



Colors are a representation and may not exactly match our colors.
Consult factory for possible color matching options on these colors.
Non-standard colors are non-returnable.

To order a Hatco Paint Chip & Stone Sample Colors Sheet, visit www.hatcocorp.com / Order Literature / Sales Literature / Sell Sheets.



Scan with web-enabled
mobile device to visit
www.hatcocorp.com

Hatco Corporation

P.O. BOX 340500 | Milwaukee, WI 53234-0500 USA

800-558-0607 | 414-671-6350

www.hatcocorp.com | support@hatcocorp.com