



**Bonn**

NOW AUSTRALIA'S NUMBER ONE CHOICE IN  
COMMERCIAL MICROWAVE OVENS

**microsave**™

# Commercial Microwave Ovens

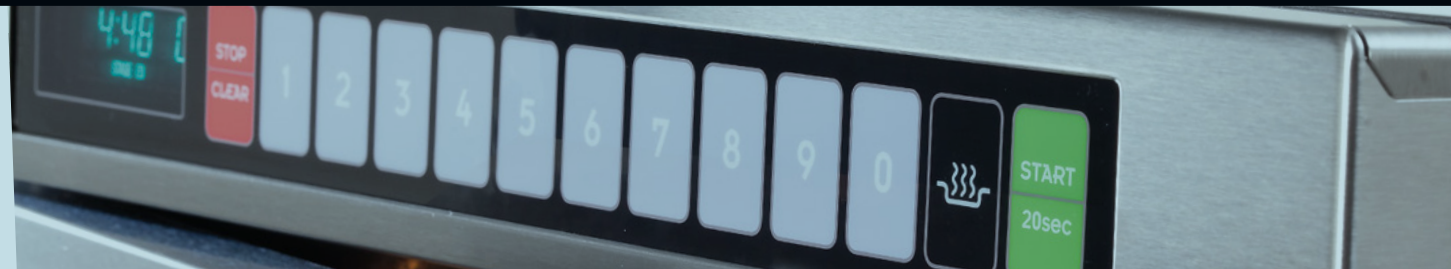

## Demand The Best

Designed and constructed to the highest of standards since 1989. Performance, reliability, safety and unsurpassed after sales service from Australia's leading commercial microwave oven brand. National franchises, restaurants, canteens, snack bars, schools, airlines, sporting stadiums, trains, testing laboratories & ships are just some of the many outlets that depend on a Bonn every day. Demand the best without compromise.

## Safety

Bonn Commercial Microwave Ovens are designed with absolute user safety in mind. Multiple door monitor switches, glass lined\* inner doors, reinforced door hinges and backup safety cutouts are just some of the many design features that ensure maximum protection to the operator. At Bonn we don't compromise and neither should you.

## Ease of Use

All Bonn Commercial Microwave Ovens feature custom programmable touch pads for easy single touch operation. Ceramic base interiors replace glass turntables to ensure maximum usable space and easy wipe cleaning.

## Speed

Bonn offers power outputs from 900watts to 1900watts dependant on your speed requirements. The graph illustrates the average difference in speed at different power outputs.

## MicroSave™ Innovation

An industry first from Bonn. The award winning MicroSave™, now available with all Bonn High Performance MicroSave™ Range ovens. The Patented MicroSave™ cavity liner offers users the only genuine solution to the potential damage cause by fat and grease spatter in any microwave oven. MicroSave™ also maintains the highest possible hygiene by containing fat & grease splatters along with spills allowing for easy cleaning. Innovative, simple and highly effective and only from Bonn.

## Warranty & After Sales Service

Bonn Commercial Microwave Ovens are supplied with industry leading warranties up to 2 years. This warranty is backed by an Australia-wide service network with more than 20 years experience. As Australia's leading Commercial Microwave Oven Brand, we understand and support our products like no other.

## Commercial Microwave Ovens Vs Domestic Microwave Ovens

Commercial Microwave Ovens are designed for the rigours of heavy duty use unlike household or domestic microwave ovens. This means far greater reliability and safety when used for extended periods of time in harsh environments. Above all, ordinary household microwave ovens are not designed to operate in commercial applications and can become unsafe for operation. Heavy duty doors, backup door switching, multiple safety cutouts & heavy gauge door hinges are some of the many features that keep your Bonn Commercial Microwave Oven in safe operation. Why compromise?

Heating Time Comparisons for Identical Product at Varying Power Output

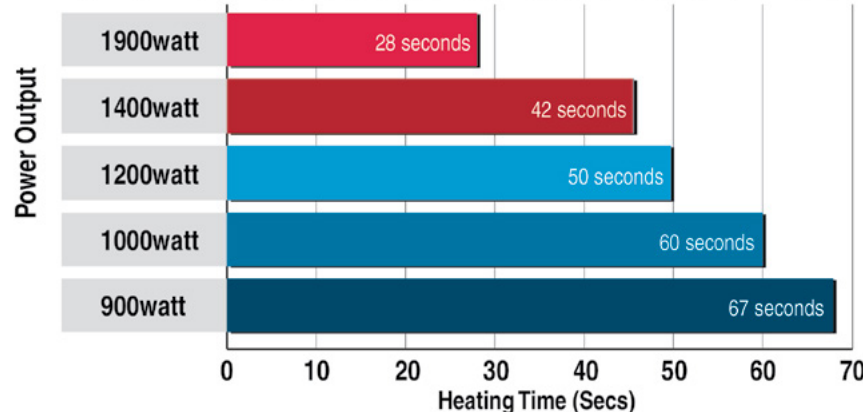

\*Model dependant

## Durability & Reliability

The durability and reliability of each Bonn Commercial Microwave owes much to the extensive testing program that each oven must withstand. Examples of such testing procedures include:

- Door Endurance Test - 400,000 door open and close testing.
- Control Panel Endurance Test - 200,000 operations of the touch pad.
- Intermittent Operation Endurance Test - On(60sec) and Off(30sec) 200,000 times, On(20sec) and Off(10sec) 200,000 times.

In a commercial kitchen the combination of various cooking equipment operating at high temperatures and the amount of steam and smoke generated creates a tough atmosphere for microwave ovens.

After closing time the temperature of the kitchen drops significantly. When designing Bonn Commercial Microwave Ovens this environment is simulated to ensure reliability.

Some of these tests include:

- Dust and Cooking Vapour Test - Operating oven in dust and cooking vapour at 40°C, humidity of 95%.
- Printed Circuit Board Evaluation Test - Printed circuit board tested in -40°C to +85°C, at 85% humidity.

*Bonn's commitment to durability and reliability has enabled longer than usual warranty periods - up to 2 years depending on the model, by far in excess of the industry norm illustrating belief in our products.*

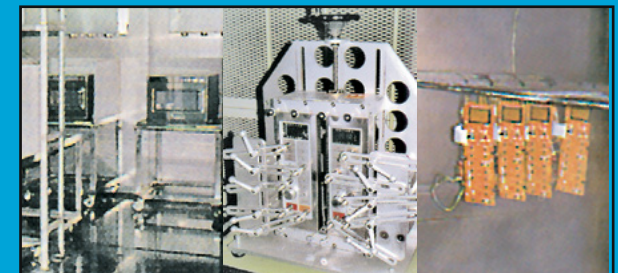

Combined stress test  
Temperature from 0°C to 40°C with Humidity of 85%

Control Panel  
Endurance  
Test Operating the keypads 200,000 times

Printed Circuit Board  
evaluation test  
Temperature from -40°C to +85°C with Humidity of 85%

## What are the benefits of having higher power output?

The greater the power output the faster the oven and hence less time is required to heat the product.

The Bonn CM-1901T with power output of 1900watts is by far the fastest oven capable of reducing heating times by up to 60%. Users looking for a significant reduction in heating times should consider the CM-1901T or CM-1401T models. These models are recommended for outlets requiring fast heating times.

## Is a Commercial Microwave Oven Faster than a Household Domestic Microwave Oven?

A commercial microwave oven will only be faster than a domestic or household microwave oven if it has a higher power output. Should both ovens have the same power output then heating time will be almost the same. The commercial oven will however be capable of operating for longer periods of time - with greater reliability and are therefore more cost effective.

## Shall I purchase 2 smaller 1100watt ovens or a single 1900watt oven for the same price?

It is more efficient to purchase 1 x CM-1901T (1900watt) oven than it is to purchase 2 x CM-1041T (1400watt) ovens.

Purchasing one high power Heavy-Duty oven is far more cost effective and efficient than purchasing two lower power lighter duty ovens.

A single 1900watt Heavy-Duty oven will also out-perform and last longer than two Lighter-Duty 1400watt ovens.

## Can a microwave heat more than one item at a time?

Microwave Ovens are designed to heat a single item at a time, not multiple items. Heating multiple items will offer little or no savings in heating time and temperature consistency throughout the items may not be consistent. The only way to increase output and maintain product consistency is to use a more powerful oven and heat single items one at a time.

## Which model is best suited to my requirements?

All microwave ovens are designed to perform a specific workload over a set period of time. This specific workload is measured by the Cost Effective Daily Workload (CEDW). The CEDW represents the maximum average usage in minutes that the oven is designed to be used for on a daily basis. Selecting the correct model oven that matches your usage patterns will ensure that you get the most cost effective microwave oven for your workload, and hence the best return on your financial investment. Selecting the incorrect oven and consistently exceeding the CEDW will almost certainly result in greater service costs and a significant reduction in the oven lifespan. In this scenario cost of ownership becomes far greater compared to selecting the correct sized oven.

The following graph illustrates the **Cost Effective Daily Workload** for all Bonn Commercial Microwave Ovens and highlights the advantages over a typical household domestic style microwave oven.

DISCLAIMER: All facts, figures and comparisons referring to Cost Effective Daily Workload, Cost Effective Working Life, Lifespan and general microwave performance are based upon usage guidelines specified by the manufacturer. All facts, figures and comparisons given may vary depending on local operating conditions, user care and usage patterns. All figures are subject to change without prior notice given.

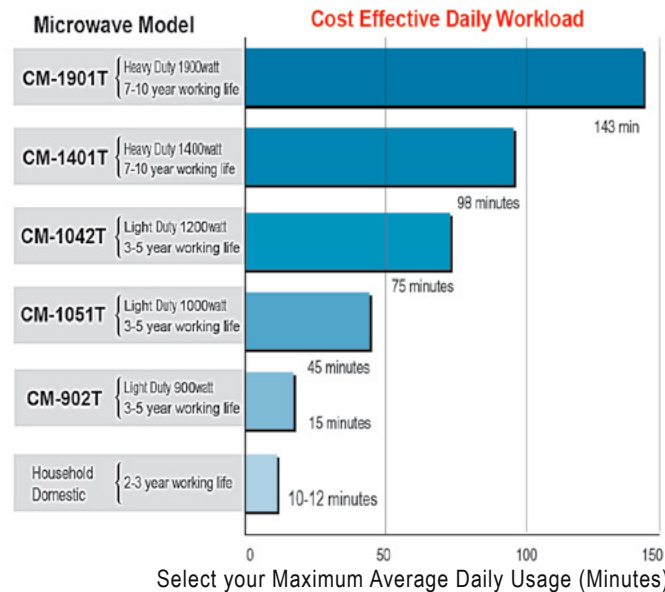

It is clear to see that the differences in workloads that these ovens are designed to perform within vary significantly.

The Heavy-Duty CM-1901T has a cost effective daily workload rating of 143 minutes, 12 times the cost effective workload of a domestic household microwave oven. In addition the CM-1901T has a working life of 7-10 years compared to just 3 years for a typical household domestic microwave oven. The CM-1901T has a cost effective working life of 7-10 years compared to 3 years for a typical household domestic style microwave oven.

The CM-1901T has a cost effective working life of 7-10 years compared to 3 years for a typical domestic household microwave oven. Taking this into consideration along with the daily usage ratings of 143 minutes compared to 12 minutes shows that a CM-1901T offers 28 times the workload of a typical household domestic microwave oven.

When taking into consideration the workload differences, oven working life and initial purchase price, and considering the Heavy-Duty workload expected of an oven in commercial use, the CM-1901T will offer a reduction in microwaving costs of approximately 75% over a typical household domestic microwave oven. Therefore selecting the correct model that fits your usage requirements is important to ensure the most cost-effective choice for your kitchen.

## What if my oven usage exceeds the Cost Effective Daily Workload?

The Daily Cost Effective workload is an average guideline. Usage in excess of this figure from time to time will cause no problem. However regular usage in excess of this figure may result in increased service requirements and a potential reduction in the lifespan of the oven, all of which increases cost of ownership.

# Protect your Microwave and improve Hygiene with

## microsave™

### Microwave oven protection liner



- 1 Reduces costly repairs by up to 80%.
- 2 Hygienic - Prevents cross contamination. Easily removed and washed in the sink or pot washer.
- 3 Extends the life of your microwave.
- 4 Safety - Maintains your microwave in a safe working condition.
- 5 Prevents fat, grease and spills inside your commercial microwave from entering impossible to clean places.
- 6 Prevents unnecessary downtime while your microwave is in for repairs.
- 7 Pest free - Prevents rodents such as cockroaches and mice attracted to spattered fat, grease and food particles from living inside the internals of your microwave oven.
- 8 Prevents major damage to the stainless steel cavity caused by arcing or sparking.
- 9 Cost effective - Costs no more than the cost of a single repair.
- 10 NSF Approved for the highest of food service standards.



# High Performance **microsave**™ Compatible Models



## CM-1901T 1900 watts

The Bonn CM-1901T with 1900watt power output offers market leading speed. Heavy duty construction, high power and Bonn's optional MicroSave™ protection makes the CM-1901T the most advanced Heavy Duty Commercial Microwave Oven and the number one choice amongst professionals.

The unique removeable MicroSave™ cavity liner reduces service costs by up to 80% and extends the life of the oven. The MicroSave™ significantly improves hygiene by collecting all spills and spatters for easy cleaning. The patented MicroSave™ liner is available as an optional extra and a must for all professional users.

The CM-1901T utilises Dual Magnetron technology reducing the operating temperature of each magnetron by up to 50% when compared to single magnetron ovens. This means longer life span with greater reliability.

### CM-1901T Dimensions and Installation Guide

All microwave ovens should be installed in a well ventilated area. Below are the recommended built in installation dimensions.

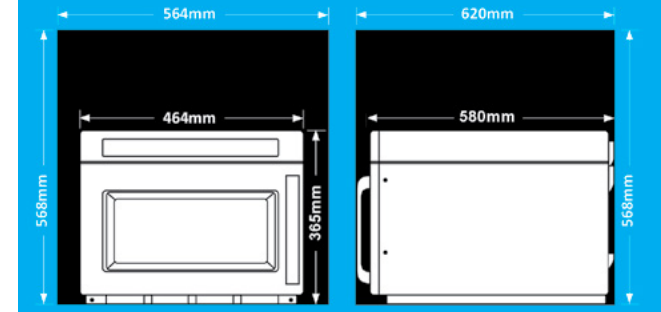

MODEL	Power Output	Oven Capacity	microsave	Programmable Control Panel	Number of Programs	Ceramic Base	CEDW**	Internal Construction	External Construction	Cavity Lighting	Inner Door Construction	Power Point Required	Weight	Current Drawn	Power Source	External Dimensions	Internal Dimensions
CM-1901T	1900 watts	26 litre	✓	✓	200	✓	2.3Hrs	Stainless Steel	Stainless Steel	Dual globes	Toughened Glass	15 amp	32kg	14.9 amp	240V - 50Hz	464w x 365h x 580d	370w x 190h x 370d



## CM-1401T 1400 watts

The Bonn CM-1401T with 1400watt power output offers market leading speed. Heavy duty, high power and Bonn's optional MicroSave™ protection.

The unique removeable MicroSave™ cavity liner reduces service costs by up to 80% and extends the life of the oven. The MicroSave™ significantly improves hygiene by collecting all spills and spatters for easy cleaning.

The patented MicroSave™ liner is available as an optional extra and is a must for all professional users.

The CM-1401T utilises Dual Magnetron technology reducing the operating temperature of each magnetron by up to 50% when compared to single magnetron ovens. This means longer life span with greater reliability.

### CM-1401T Dimensions and Installation Guide

All microwave ovens should be installed in a well ventilated area. Below are the recommended built in installation dimensions.

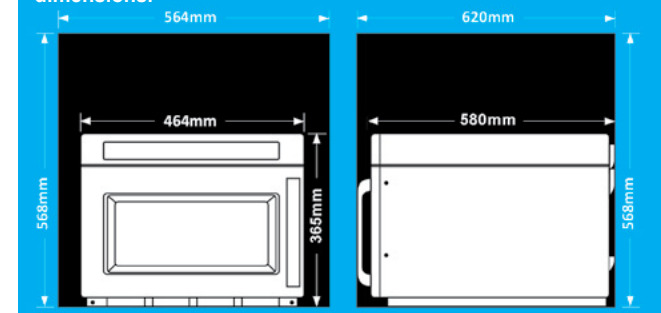

MODEL	Power Output	Oven Capacity	microsave	Programmable Control Panel	Number of Programs	Ceramic Base	CEDW**	Internal Construction	External Construction	Cavity Lighting	Inner Door Construction	Power Point Required	Weight	Current Drawn	Power Source	External Dimensions	Internal Dimensions
CM-1401T	1400 watts	26 litre	✓	✓	200	✓	1.6Hrs	Stainless Steel	Stainless Steel	Dual globes	Toughened Glass	10 amp	32kg	9.9 amp	240V - 50Hz	464w x 365h x 580d	370w x 190h x 370d

\*2 year parts and 13 month labour warranty is on-site for the CM-1901T & CM-1401T Models \*\*CEDW - Cost Effective Daily Workload

# Bonn

## High Performance **microSAVE**™ Range Features

### Direct Ducted Magnetron Cooling

Industry leading magnetron life span. Unique ducted design by Bonn. Cold air is plumbed directly into the magnetron, with hot exhaust air plumbed to exit the oven achieving maximum cooling efficiency.

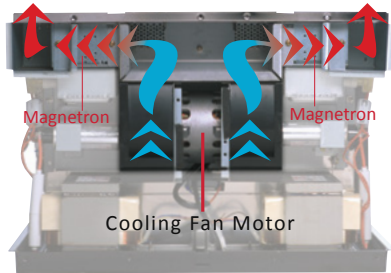

### Motorised Stirrer Fans

Concealed Stirrer Fans for even heating of food.



### Programmable Touch Pad

Up to 200 fully customisable programs for easy, rapid heating.



### Dual Magnetron Technology

Power output is shared between both magnetrons reducing magnetron temperature. Greater power with greater reliability.



### Grab'n'Go Door Handle

Heavy Duty trigger-less metal door handle for years of reliable use.



### Heavy Duty Door Safety Latch

All metal door safety latches for maximum safety to user.

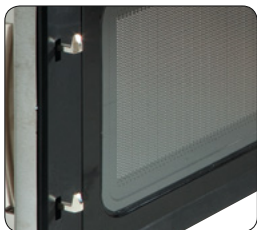

### Safety Toughened glass

(not film) inner door screen protects door grill, preventing possible microwave leakage and maximum safety to user.

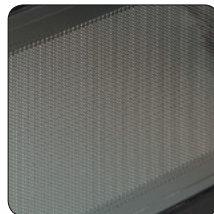

### microSAVE™ Cavity Liner

(Optional Extra)

Removeable cavity liner captures all spills and splatters for easy cleaning and maximum hygiene. Extends oven life, reduces service costs by up to 80%. Keeps oven in new condition.



### Double Lamp Design

Dual lamps for brighter lighting with easy replacement panel.

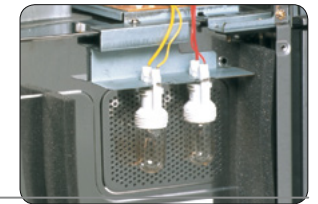

### Ceramic Base

Larger useable space when compared to rotating glass turntable.





# Performance Range Models



## CM-1042T **1200 watts**

The CM-1042T offers users preset programming, ceramic base, stainless steel construction, generous 22 litre capacity and a powerful 1200watt output.

Incorporating new latest generation high efficiency magnetron with 1200watt output.

The CM-1042T has incorporated many of the design features from the Bonn High Performance Range of ovens. These include Direct Ducted Magnetron Cooling, Motorised Stirrer Fan for even heating along with all safety features such as toughened inner door glass, heavy duty door safety latches and double strengthened door hinges all part of Bonn's stringent total safety philosophy.

**Supplied with 2 Years Parts/13 month Labour warranty\*.**

### CM-1042T Dimensions and Installation Guide

All microwave ovens should be installed in a well ventilated area. Below are the recommended built in installation dimensions.

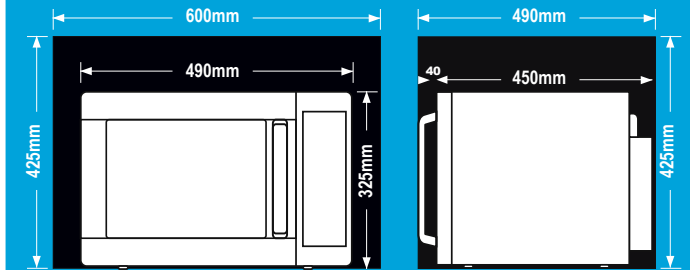

MODEL	Power Output	Oven Capacity	microsave	Programmable Control Panel	Number of Programs	Ceramic Base	CEDW**	Internal Construction	External Construction	Cavity Lighting	Power Point Required	Weight	Current Drawn	Power Source	External Dimensions	Internal Dimensions
CM-1042T	1200 watts	21 litre	X	✓	20	✓	1.25Hrs	Stainless Steel	Stainless Steel	X	10 amp	19.5kg	8.5 amp	240V - 50Hz	490w x 325h x 450d	310w x 209h x 325d



## CM-1051T **1000 watts**

Stainless Steel internal & external construction, programmable touch pad, ceramic base, generous 22 litre oven capacity with 1000watt output.

The CM-1051T includes design features such as Direct Ducted Magnetron Cooling, Motorised Stirrer Fan for even heating along with all safety features such as toughened inner door glass, heavy duty door safety latches and double strengthened door hinges.

Ideal for long lasting performance and reliability in school tuck shops, snack bars, fast food vans and front of house heating requirements.

**Supplied with 2 Years Parts/13 month Labour warranty\*.**

### CM-1051T Dimensions and Installation Guide

All microwave ovens should be installed in a well ventilated area. Below are the recommended built in installation dimensions.

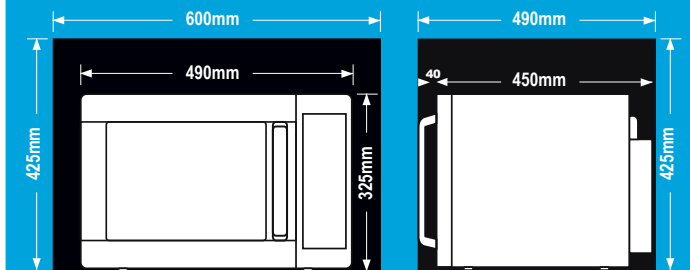

MODEL	Power Output	Oven Capacity	microsave	Programmable Control Panel	Number of Programs	Ceramic Base	CEDW**	Internal Construction	External Construction	Cavity Lighting	Power Point Required	Weight	Current Drawn	Power Source	External Dimensions	Internal Dimensions
CM-1051T	1000 watts	21 litre	X	✓	20	✓	45 minutes	Stainless Steel	Stainless Steel	X	10 amp	19.5kg	7.6 amp	240V - 50Hz	490w x 325h x 450d	310w x 209h x 325d

\*2 year parts and 13 month labour warranty is back to base for the CM-1042T & CM-1051T Models \*\*CEDW - Cost Effective Daily Workload

## Performance Range Features

### Grab'n'Go Door Handle

Heavy Duty trigger-less metal door handle for years of reliable use.



### Direct Ducted Magnetron Cooling Design

Industry leading magnetron life span. Unique ducted design by Bonn. Cold air is plumbed directly into the magnetron, with hot exhaust air plumbed to exit the oven achieving maximum cooling efficiency.

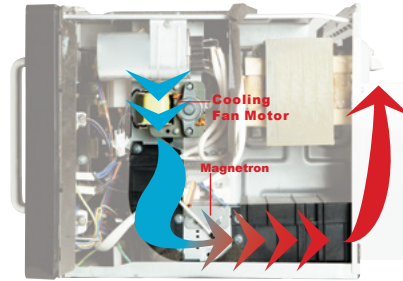

### Programmable Touch Pad

20 programmable presets for easy, rapid heating of meals.



### High Efficiency Magnetron

Latest generation magnetron design enabling power output up to 1200 watts.



### Heavy Duty Door Safety Latch

Heavy Duty nylon door latches, guarantees maximum safety to user.



### Safety

Toughened glass (not film) inner door screen protects door grill, preventing possible microwave leakage and maximum safety to user.



### Motorised Stirrer Fan

Concealed Stirrer Fan for even heating of food.



### Ceramic Base

Easy clean up of spills and larger useable space when compared to rotating glass turntable.





## Light Duty Range Features



### CM-902T **900 watts**

The CM-902T incorporates a fully programmable touch pad in an entry level compact light duty package. The CM-902T also features internal and external stainless steel construction ceramic base and motorised stirrer fan to ensure ease of cleaning and maximum usability from its 25 litre capacity.

**Supplied with 13 Month Parts and Labour back to base warranty.**

### CM-902T Dimensions and Installation Guide

All microwave ovens should be installed in a well ventilated area. Below are the minimum recommended built in installation dimensions.

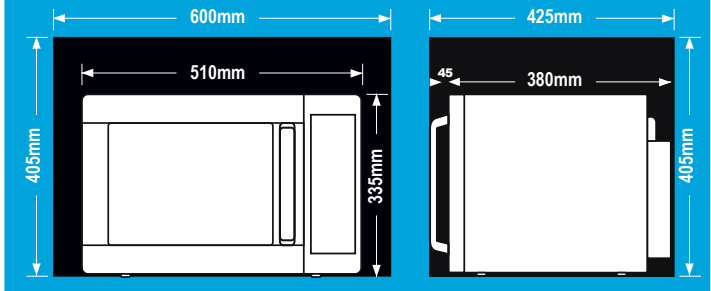

MODEL	Power Output	Oven Capacity	Programmable Control Panel	Number of Programs	1-3 Stage Cooking	Power Levels	Ceramic Base	microsave	CEDW**	Internal Construction	External Construction	Cavity Lighting	Power Point Required	Weight	Current Drawn	Power Source	External Dimensions	Internal Dimensions
CM-902T	900 watts	25 litre	✓	10	✓	4	✓	✗	15 Minutes	Stainless Steel	Stainless Steel	✗	10 amp	15kg	6.5amp	240V - 50Hz	510w x 335h x 380d	330w x 212h x 330d

\*\*CEDW - Cost Effective Daily Workload

Bonn Microwave products are available throughout Australia, leading the industry with proven technologies, innovative design, a range to suit every kitchen production requirement, and are backed up by an Australia-wide service network. Whether you run a small tuckshop, premium gourmet food restaurant or large production kitchen facility, Bonn has the technology and model to suit, with excellent advice from our food service experienced team. Speak to us about your requirements and let us guide you through the process so you can be confident that your decision is based on facts and performance capability rather than just price. We have an ever-increasing range of specialised food service products extending to kitchen exhaust canopies, food holding/warming systems/refrigeration and the best range of high quality food preparation equipment from major manufacturers around the globe.

**FSM** (FOOD SERVICE MACHINERY PTY. LTD.)

#### HEAD OFFICE:

21-23 Agosta Drive, Laverton North,  
Vic. 3026 Australia  
T: +61 3 9368 2300 F: +61 3 9369 3800  
E: sales@fsm-pl.com.au W: www.fsm-pl.com.au

#### SYDNEY OFFICE:

Unit 15, 7-9 Progress Circuit,  
Prestons, NSW 2170  
T: +61 2 9608 8620 F: +61 2 9607 9370  
E: sales@fsm-pl.com.au W: www.fsm-pl.com.au

#### QUEENSLAND OFFICE:

4/40 Rivergate Place,  
Murarrie, QLD 4172  
T: +61 7 3390 4185 F: +61 7 3393 9508  
E: sales@fsm-pl.com.au W: www.fsm-pl.com.au

#### PERTH:

T: 0413 893 311  
E: sales@fsm-pl.com.au  
W: www.fsm-pl.com.au