

# Owner's Manual

FOR COMMERCIAL USE ONLY

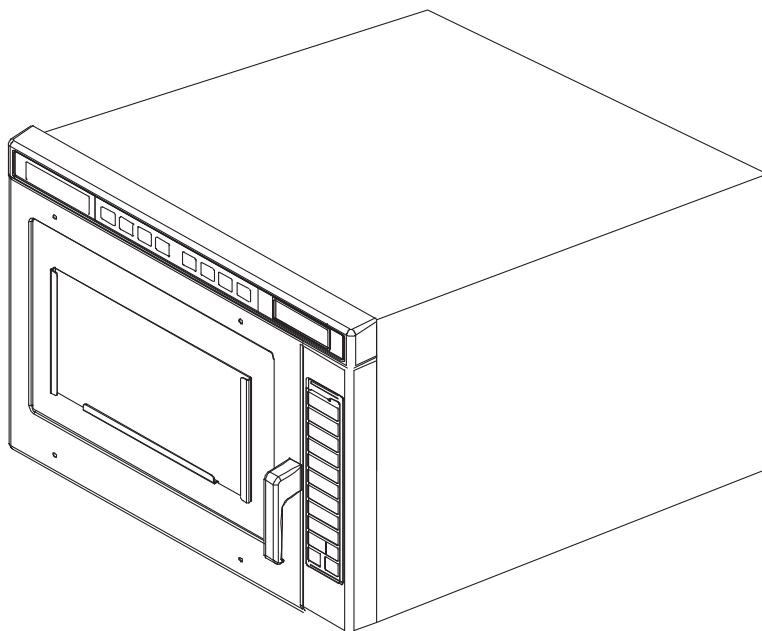

## Commercial Combination Oven (Microwave and Convection)

Keep these instructions for future reference. If the equipment changes ownership, be sure this manual accompanies equipment.

### Contents

Model Identification .....	2
Grounding Instructions .....	3
Installation .....	3
Display and Features .....	4
Programming.....	7
Convection Cooking .....	8
Combination Cooking (microwave and convection) .....	9
User Options .....	10
EZCard Operating Instructions.....	11
User Maintenance .....	12
Service Codes.....	12
Care and Cleaning .....	13
Before Calling Service.....	14

# Model Identification

When contacting ACP, provide product information. Product information is located on oven serial plate.

---

Record the following information:

Model Number: \_\_\_\_\_

Serial or S/N Number: \_\_\_\_\_

Date of installation: \_\_\_\_\_

Dealer's name and address: \_\_\_\_\_

\_\_\_\_\_

Any questions or to locate an authorized ACP servicer, call ACP ComServ Service Support.

–**Inside** the U.S.A. or Canada, call toll-free at 866-426-2621.

–**Outside** the U.S.A. and Canada, call 319-368-8120.

–**Email:** [Commercialservice@acpsolutions.com](mailto:Commercialservice@acpsolutions.com).

Warranty service must be performed by an authorized ACP servicer. ACP also recommends contacting an authorized ACP servicer, or ACP ComServ Service Support if service is required after warranty expires.

# Installation

## Unpacking Oven

- Inspect oven for damage such as dents in door or inside oven cavity.
- Report any dents or breakage to source of purchase immediately.  
**Do not attempt to use oven if damaged.**
- Remove all materials from oven interior.
- If oven has been stored in extremely cold area, wait a few hours before connecting power.

## Radio Interference

Microwave operation may cause interference to radio, television, or a similar oven. Reduce or eliminate interference by doing the following:

- Clean door and sealing surfaces of oven according to instructions in *Care and Cleaning* section.
- Place radio, television, etc. as far as possible from oven.
- Use a properly installed antenna on radio, television, etc. to obtain stronger signal reception.

## Oven Placement

- Do not install oven next to or above source of heat, such as pizza oven or deep fat fryer. This could cause microwave oven to operate improperly and could shorten life of electrical parts.
- Do not block or obstruct oven filter. Allow access for cleaning.
- Install oven on level countertop surface.
- If provided, place warning label in a conspicuous place close to microwave oven.
- Outlet should be located so that plug is accessible when oven is in place.

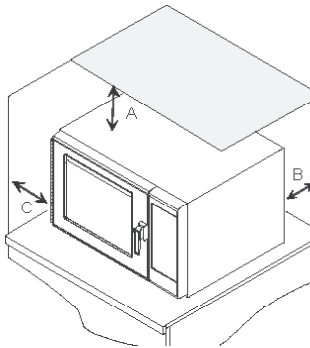

- A—For North American (UL/CSA) models, allow at least 2" (5.1 cm) of clearance around top of oven. For International (50 Hz) models, allow at least 7" (17,8 cm) of clearance around top of oven. Proper air flow around oven cools electrical components. With restricted air flow, oven may not operate properly and life of electrical parts is reduced.
- B—Allow at least 2 9/16" (6,5 cm) between air discharge on back of oven and back wall.
- C—Allow at least 1 1/4" (3 cm) of clearance around sides of oven.

### Oven Clearances

The switching operation of this microwave oven can cause voltage fluctuations on the supply line. The operation of this oven under unfavorable voltage supply conditions can have adverse effects. This device is intended for the connection to a power supply system with a maximum permissible system impedance  $Z_{max}$  of **1.1 Ohm** at the interface point of the user's supply. The user has to ensure that this device is connected only to a power supply system which fulfills the requirement above. If necessary, the user can ask the public power supply company for the system impedance at the interface point.

## WARNING

To avoid risk of electrical shock or death, this oven must be grounded and plug must not be altered.

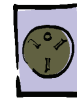

## Earthing Instructions Oven **MUST** be grounded.

Grounding reduces risk of electric shock by providing an escape wire for the electric current if an electrical short occurs. This oven is equipped with a cord having a grounding wire with a grounding plug. The plug must be plugged into an outlet that is properly installed and grounded.

Consult a qualified electrician or servicer if grounding instructions are not completely understood, or if doubt exists as to whether the oven is properly grounded.

### Do not use an extension cord.

If the product power cord is too short, have a qualified electrician install a three-slot receptacle. This oven should be plugged into a separate circuit with the electrical rating as provided in product specifications. When the combination oven is on a circuit with other equipment, an increase in cooking times may be required and fuses can be blown.

## External Equipotential

### Earthing Terminal (*export only*)

Equipment has secondary earthing terminal. Terminal provides external earthing connection used in addition to earthing prong on plug. Located on outside of oven back, terminal is marked with symbol shown below.



# Display and Features

---

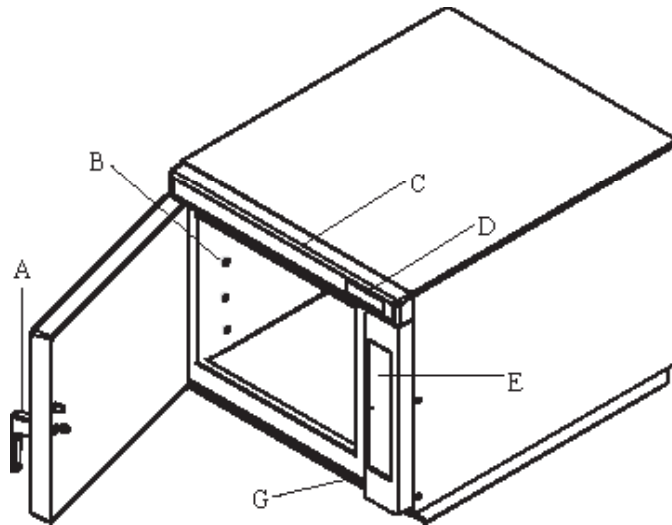

- A—Oven Door Handle (Lift to open.)
- B—Rack Guides
- C—Top Control Panel
- D—Display

- E—Side Control Panel
- G—Air Intake Filter (some models)

---

## Oven Features

Standby shows in display after oven door has been opened and closed, or after turning oven OFF with the Preheat On/Off pad.

**Standby**

**Oven Preheating  
450°F or 230°C**

Oven Preheating and set temperature shows in display after pressing Preheat On/Off pad. (example of 450°F shown)

# Display and Features (cont'd)

Ready and set temperature displays after pressing Preheat On/Off pad. Ready indicates the oven is up to temperature. (example of 450°F shown)



Indicates oven is in a preprogrammed cooking program

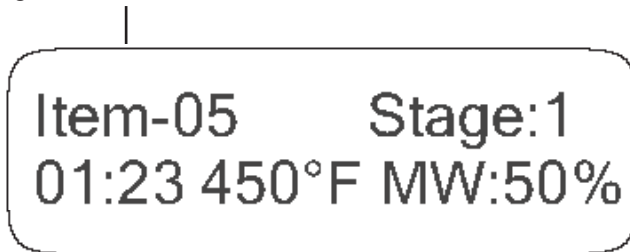

Cooking information shows in display after pressing a single (or double) digit pad while in Ready Mode.

Time left in cooking program

Cooking temperature  
450°F or 230°C

Percentage of microwave power

Indicates oven is in a manual cooking program

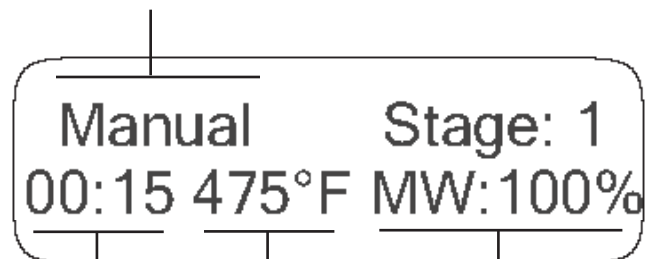

Time left in cooking condition

Cooking temperature  
475°F or 250°C

Indicates percentage of microwave power

# Display and Features (cont'd)



## Start pad

The Start pad is used to begin a manual time entry cooking cycle.



## Stop/Reset pad

The Stop/Reset pad stops a cooking sequence in progress, clears out any remaining time, and also ends a programming or user option cycle. When the Stop/Reset pad is used to end a programming or option change, the changes are discarded.

## Temperature warnings

The combination oven has two distinct temperature warnings. Warnings sound with a three beep signal when a programmed pad is pressed. Warnings are:

- A warning when the preheat temperature does not match the preprogrammed temperature of a cooking condition.
- A warning when the actual oven cavity temperature is not to preheat temperature, such as when the oven is first started.

To override the warning and begin a cooking cycle, press the Start pad. To turn off warnings, see *User Options* section.

## Cooking Display

### DISPLAYS

### DESCRIPTION

**OVEN PREHEATING 450°F**

**Oven Preheating 450°F or 230°C** displays when oven is turned on and is warming up to the selected preheat temperature. **Oven Preheating** also flashes when a cooking condition can be started or programmed. (example of 450°F shown)

**READY 450°F**

**Ready 450°F or 230°C** displays when oven has reached preheat temperature and is ready to cook. **Ready** also flashes when a cooking condition can be started or programmed. (example of 450°F shown)  
**Note:** Oven will shutdown after two hours of inactivity.

**00:00**

Displays cooking time. If stage cooking is programmed, total cooking time is displayed

**MW 50%**

**MW 50%** displays the current microwave power level. 100% is the highest setting, and 0% is lowest (no microwave energy used). (example of 50% shown)

**ITEM-05**

**ITEM-05** displays the single or double digit entry of a programmed cooking condition when using a programmed pad. (example of Item 05 shown)

**STAGE 1**

**Stage 1** displays to show the stage number (1 through 4) the oven is at in the cooking condition

**STANDBY**

**STANDBY** displays when oven is turned off, and also after the oven is plugged in, the door is opened, and then shut.

## Programming Display

### DISPLAYS

### DESCRIPTION

**Enter Program to Add/Review:**







Displays when oven is in programming mode for single pad or double pad memory.

**STAGE 1**

Displays stage number during cooking or when programming a specific cooking stage. Stage number (1 through 4) indicates the stage that is being used.



## Programming Pads

Oven is shipped from the factory for single pad programming. To change the oven default to double pad programming, see *User Option* section. To program the amount of time, power level, or temperature setting for a pad:

1. Oven must be ON.
  - Press Preheat On/Off pad. 
  - **Oven Preheating 450°F or 230°C** shows in display with **Oven Preheating** flashing. (example of 450°F shown)
2. Oven reaches preheat temperature.
  - Signal sounds and **Ready 450°F or 230°C** shows in display with **Ready** flashing. (example of 450°F shown) 
2. Press Program Save pad.
  - Programming mode begins.
  - **Enter Program to Add/Review:** shows in display.
3. Press pad to be programmed or reprogrammed.
  - Display will change to review all settings for the pad.
  - The pad number that is being programmed displays beside the word **ITEM.** 
4. Press Time Entry pad to program amount of cooking time.
  - Enter desired cooking time by using numeric key pads.
  - The total microwave cooking time (all stages combined) is 20 minutes. 
5. Press Temp Entry pad to program the cooking temperature.
  - Enter desired convection temperature by using numeric pads. 
6. Press Power Level pad to program level of microwave power.
  - Press numeric key pad for desired level. Press numeric key pad again to set power level to 100%. 
  - For a lower microwave power, press pads 1 (for 10%) through 9 (for 90%). **0 turns off the microwave power and cooking is by convection only.** 
7. Press Program Save pad to save the program changes.
8. To discard changes, press Stop/Reset pad.

## Programming Multiple Stages

Stage cooking allows consecutive cooking cycles without interruption. Up to four different cooking cycles can be programmed into a memory pad. To use stage cooking:

1. Follow steps 1 through 6 above.
7. Press Stage pad.
  - This will begin programming for the next cooking stage. 
  - Display indicates stage to be programmed.
  - Enter cook time, temp and power level as in steps 4, 5 and 6.
  - To enter another cooking stage for that pad, press Stage pad again.
  - Up to four different stages can be programmed.
8. Press Program Save pad to save the program and changes. 
9. To discard changes, press Stop/Reset pad before pressing Program Save pad.

## Programming Preheat Setting

The convection temperature setting can be set between 150°F to 475°F (65°C to 250°C). It is recommended to set the preheat setting to the most commonly used temperature for that oven. The factory default preheat setting is 450°F (230°C).

**To program the preheat setting:**

1. Press Program Save pad.
2. Press Temp Entry pad.
3. Enter desired temperature by using the numeric key pads.
  - Temperature must be entered in 25°F (10°C) increments. If not, the temperature will automatically change to the nearest 25°F (10°C).
4. Preheat temperature is changed



## What is stage cooking?

Stage cooking enables several different cooking cycles, or stages, to be used consecutively without repeated input from the user. Stage cooking can be set to defrost food initially, then cook it, and then keep the food warm until serving time.

Example of Stage Cooking Conditions

	Stage 1	Stage 2	Stage 3	Stage 4
<b>Temp</b>	450°F	450°F	450°F	450°F
<b>Power</b>	100%	30%	0	50%
<b>Time</b>	2:30	1:30	1:30	1:00

# Convection Cooking



## CAUTION

To avoid risk of burns, handle utensils, racks, and door with care. Allow oven, utensils, and racks to cool before cleaning. Oven, utensils, and racks, become hot during operation.

To operate the oven for convection cooking only, you can use preprogrammed pads or manual time entry. **The following instructions are for convection cooking only.** For combination cooking, see that section.

## Convection Cooking

Convection cooking utilizes both a convection element and fan to evenly distribute heated air throughout the oven cavity. By circulating air, no hot or cold spots occur, creating a consistent temperature envelope around the food. These consistent temperatures cook food evenly and reduces cooking time. Oven will always operate in convection mode.

### Convection Cooking with Programmed Pads

1. Press Preheat On/Off pad to start the oven.
  - Oven begins a preheat cycle.
  - **Oven Preheating 450°F or 230°C** shows in display. (example of 450°F shown)
  - To change preheat temperature, see *Programming*.
2. Oven reaches preheat temperature.
  - Signal sounds and **Ready 450°F or 230°C** displays.
3. Press selected pad.
  - If using single pad programming, press pad and oven begins automatically.
  - For double pad programming, press pads in proper sequence and oven begins automatically.
4. Cooking cycle begins
  - Preprogrammed cooking program, total cooking time, cooking temperature, percentage of microwave power, and stage are all displayed.
5. Oven finishes cooking sequence
  - An end of cycle beep signals the end of the cooking cycle.
  - **Done** shows in display.
  - **Oven interior and cooking dish will be hot.**
6. Press Preheat On/Off pad to shut off oven.



### Convection Cooking Using Manual Cooking Operation

1. Press Preheat On/Off pad to start the oven.
  - Oven begins a preheat cycle.
  - **Oven Preheating 450°F or 230°C** shows in display. (example of 450°F shown)
  - To change preheat temperature, see *Programming*.
2. Oven reaches preheat temperature.
  - Signal sounds and **Ready 450°F or 230°C** displays.
3. Place food in the oven.
4. Press Time Entry pad.
  - Enter desired cooking time by using the numeric keypad.
5. Press Temp Entry pad if cooking temperature differs from preheat temperature.
  - Enter the new temperature.
6. Press Power Level pad.
  - Press numeric key pad for desired level. Press numeric key pad again to set power level to 100%.
  - For a lower microwave power, press pads 1 (for 10%) through 9 (for 90%). **0 turns off the microwave power and cooking is by convection only.**
7. If stage cooking is desired, press Stage pad and repeat steps 3, 4, and 5.
  - Up to 4 different stages can be programmed.

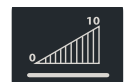



# Combination Cooking (microwave and convection)



## CAUTION

To avoid risk of burns, handle utensils, racks, and door with care. Allow oven, utensils, and racks to cool before cleaning. Oven, utensils, and racks, become hot during operation.

To operate the oven for combination cooking, you can use preprogrammed pads or manual time entry. **The following instructions are for combination cooking only.** For convection only cooking, see that section.

### Combination Cooking With Preprogrammed Pads

1. Press Preheat On/Off pad to start the oven.
  - Oven begins a preheat cycle.
  - **Oven Preheating 450°F or 230°C** shows in display. (example of 450°F shown)
  - To change preheat temperature, see *Programming*.
2. Oven reaches preheat temperature.
  - Signal sounds and **Ready 450°F or 230°C** displays.
3. Press selected pad.
  - If using single pad programming, press pad and oven begins automatically.
  - For double pad programming, press pads in proper sequence and oven begins automatically.
4. Cooking cycle begins
  - Preprogrammed cooking program, total cooking time, cooking temperature, percentage of microwave power, and stage are all displayed.
5. Oven finishes cooking sequence
  - An end of cycle beep signals the end of the cooking cycle.
  - **Done** shows in display.
  - **Oven interior and cooking dish will be hot.**
6. Press Preheat On/Off pad to shut off oven.



### Combination Cooking

The combination mode uses both the speed of **microwave energy** and browning of **convection** cooking to yield fast, high quality food.

- Microwave cooking uses high frequency energy waves to heat the food. When cooking, microwave energy causes food molecules to move rapidly. This rapid movement between the food molecules creates heat, which cooks the food. POWER displays when oven is generating microwave energy for the current cycle.
- Convection cooking uses the selected oven temperature to bake and brown foods. The circulating air surrounds food in an envelope of evenly heated air.
- Oven will maintain a minimum convection temperature of 65°C (150°F) to ensure drier air and more even cooking.

### Combination Cooking Using Manual Cooking Operation

1. Press Preheat On/Off pad to start the oven.
  - Oven begins a preheat cycle.
  - **Oven Preheating 450°F or 230°C** shows in display. (example of 450°F shown)
  - To change preheat temperature, see *Programming*.
2. Oven reaches preheat temperature.
  - Signal sounds and **Ready 450°F or 230°C** displays.
3. Press Time Entry pad.
  - Enter desired cooking time by using the numeric keypad.
4. Press Temp Entry pad if cooking temperature differs from preheat temperature.
  - Enter the new temperature.
5. Press Power Level pad.
  - Press numeric key pad for desired level. Press numeric key pad again to set power level to 100%.
  - For a lower microwave power, press pads 1 (for 10%) through 9 (for 90%). **0 turns off the microwave power and cooking is by convection only.**
6. If stage cooking is desired, press Stage pad and repeat steps 3, 4, and 5.
  - Up to 4 different stages can be programmed.
7. Press the Start pad to begin the cooking cycle.



# User Options

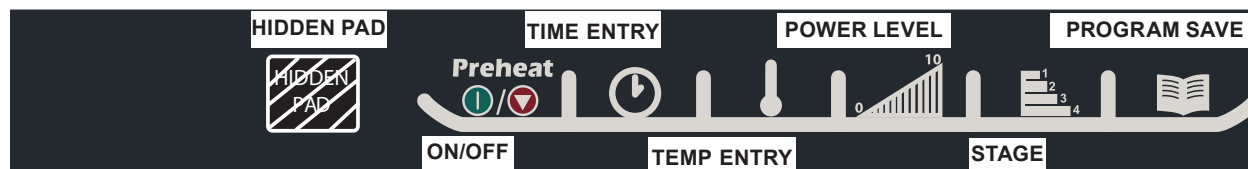

## Changing user options

Options such as single or double pad programming, beep volume, and maximum cooking time can be changed to suit individual preferences.

### Didn't like an option?

Factory settings are marked in bold.

To change the oven back to the factory setting, simply select the option that is marked in bold.



### My changes weren't saved.

In order for any changes to be saved, the Program Save pad must be pressed after selecting an option. Pressing the Stop/Reset pad will not save changes.

### To change options oven STANDBY must display:

1. Press hidden pad.
  - Pad is unmarked and located to the direct left of Preheat On/Off pad.
  - Nothing will be displayed when hidden pad is pressed.
2. Press Program Save pad.
  - The first user option will display. Oven is now in options mode.
3. Press number pad that controls option to be changed.
  - See table below for options.
  - Current option will display.
4. Press numeric pad again to change the option.
  - Each time pad is pressed, option will change.
  - Match code displayed with code for desired option.
  - To change additional options, repeat steps 3 and 4.
  - Changes take affect after pad is pressed. Press Program Save to save.
5. Press Stop/Reset pad to return to STANDBY, or open and close oven door.

Keypad	Display	Options (Factory Settings in Bold)
<b>1</b> Double Digit Entry	Disabled Enabled	<b>Allows 10 (0-9) preprogrammed pads.</b> Allows 100 (00-99) preprogrammed pads.
<b>2</b> Manual Time Entry	Disabled Enabled	Manual time entry/cooking not allowed <b>Manual time entry/cooking allowed</b>
<b>3</b> Reset on Door Open	Disabled Enabled	<b>Opening oven door does not reset oven back to ready mode</b> Opening oven door resets the oven back to ready mode
<b>4</b> Keybeep	Disabled Enabled	Keys do not beep when pressed (keybeep off) <b>Keys beep when pressed (keybeep on)</b>
<b>5</b> Keybeep Volume	OFF LOW MEDIUM HIGH	Keybeep volume OFF Keybeep volume LOW Keybeep volume MEDIUM <b>Keybeep volume HIGH</b>
<b>6</b> End of Cook Signal	Solid Beep <b>3 Second Beep</b> 4 Beeps Once 4 Beeps Repeating	Food done signal is a continuous beep until reset by user <b>Food done signal is a three second beep</b> Food done signal is four beeps, continuously Food done signal is four beeps, four times
<b>7</b> Keypad Active	15 SECONDS 30 SECONDS <b>60 SECONDS</b> 120 SECONDS ALWAYS	Keypad time entry window is 15 seconds Keypad time entry window is 30 seconds <b>Keypad time entry window is one minute</b> Keypad time entry window is two minutes Keypad time entry window is always active
<b>8</b> Preheat Warnings	Disabled Program Temp Cavity Temp Both	<b>Both temperature warnings off</b> Warning only when preheat temperature does not match preprogrammed temperature Warning only when actual oven cavity temperature is not to preheat temperature Both temperature warnings on
<b>TEMP PAD</b> Temperature Scale	Degrees F Degrees C	Temperatures are displayed in °F for 60 Hz models Temperatures are displayed in °C for 50 Hz models
<b>STAGE PAD</b> CLEAN FILTER Message Frequency	Disabled <b>Weekly</b> Monthly Quarterly	Oven will not display Clean Filter <b>Oven will display Clean Filter every seven (7) days</b> Oven will display Clean Filter every thirty (30) days Oven will display Clean Filter every ninety (90) days

# EZCard Operating Instructions (some models)

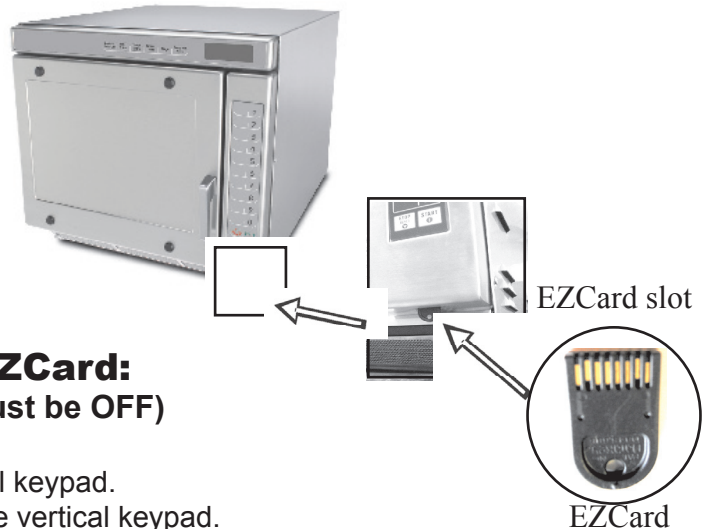

## To program the oven using the EZCard: Oven must be in Standby mode (Preheat must be OFF)

1. Remove protective cover from bottom of vertical keypad.
2. Insert the EZCard into the slot located below the vertical keypad.
  - The EZCard can be inserted forwards or backwards.
3. Open and close door.
4. Press and hold the Program Save pad for 3 seconds.
  - **AUTO**, then **PROG** displays briefly, repeating this sequence every second as the EZCard automatically programs the oven.
  - When the oven programming is complete, **DONE** shows in the display for 3 seconds and the oven beeps.
  - The oven resets to the standby mode.
5. Remove the EZCard.
  - The oven programming is now complete.
6. Place protective cover back over slot in bottom of control panel.

**Caution:**  
DO NOT REMOVE EZCard while programming. Removing card during programming can cause the oven's keypad to freeze up.

**NOTE:** If **00:00** displays, 3 beeps sound and the display returns to the Standby mode, the EZCard was not detected.

- Reinsert the EZCard into the slot and try each step again.
- If after several attempts, the EZCard is still not detected, contact ACP ComServ Service Support.
  - Inside** the U.S.A. or Canada, call toll-free at 866-426-2621.
  - Outside** the U.S.A. and Canada, call 319-368-8120.
  - Email:** [commercialservice@acpsolutions.com](mailto:commercialservice@acpsolutions.com).



Use this option only to transfer data from the oven **TO** the EZCard. **This will overwrite all programming on the EZCard!**

## To transfer programming from the oven to the EZCard: Oven must be in Standby mode (Preheat must be OFF)

1. Remove protective cover from bottom of vertical keypad.
2. Insert the EZCard into the slot located below the vertical keypad.
  - The EZCard can be inserted forwards or backwards.
3. Open and close door.
4. Press the Program Save pad.
5. Press the START pad.
6. Press the 1 pad, the 3 pad, and then the 5 pad.
  - The programming transfer will begin automatically and the display will show moving dashes.
  - When the programming transfer is complete, **DONE** shows in the display for 3 seconds and the oven beeps.
  - The oven resets to the standby mode.
7. Remove the EZCard.
  - The programming transfer is now complete.
8. Place protective cover back over slot in bottom of control panel.

To order additional EZCards, call the ACP Commercial Inside Sales Team toll-free at 800-233-2366 (U.S.A. or Canada), or 319-368-8120 (outside the U.S.A. and Canada).

# User Maintenance

---

## Service codes

During operation, the oven may display a service code. **If this should occur:**

1. Unplug oven and leave unplugged for approximately one minute. Plug oven in and see if code reappears.
  - If code does not reappear, continue normal use with the oven.
2. If service code reappears, write down the service code displayed and contact the nearest authorized ACP Servicer.
  - Do not use oven until contacting the ACP Servicer.

## Error2

(example)

# Care and Cleaning

Clean oven frequently to maximize oven life, performance, and efficiency. A dirty oven cooks inefficiently because moisture, spills, and grease absorb convection and microwave energy.

## WARNING

To avoid electrical shock which can cause severe personal injury or death, unplug power cord or open circuit breaker to oven before cleaning oven.



## CAUTION

To prevent burns, handle utensils, racks, and door with care. Allow oven, utensils, racks to cool before cleaning. Oven, utensils, and racks, become hot during operation.

**FOR A NEW OVEN:** before using it the first time, spray damp towel with ACP Oven Shield and wipe all interior surfaces. Do not remove Oven Shield Oven Protectant (Item# SH10). Turn oven on and pre-heat to start cooking.

### I. Daily Cleaning Recommendations:

**Recommended Cleaning Supplies:** damp towel, plastic scouring pad, ACP Oven Cleaner (Item # CL10) and ACP Oven Shield Oven Protectant (Item# SH10). Avoid spraying caustic cleaners or those containing ammonia, phosphates, chlorine, sodium or potassium hydroxide (lye) directly on oven surfaces.



**1. Shut oven off**  
Press the Preheat On/Off pad. Allow oven to cool down to 150°F (65°C) or lower (approximately 10-15 minutes with the door open and 45-60 minutes with the door closed).

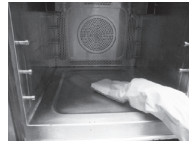

#### **4. Clean and Wipe Oven Interior**

Clean the oven using a composite scouring pad. Wipe the oven interior using a damp clean towel, rinse towel and wring dry. Repeat 2-3 times to remove remaining oven cleaner and particles from the oven. If needed, repeat steps 4 and 5.

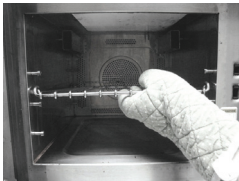

**2. Remove rack and accessories.** Wash with warm soapy water and allow to air dry while cleaning oven interior. Clean pizza stone by using a plastic scraper and a damp cloth only.

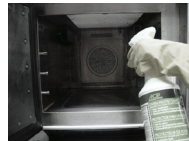

#### **5. Spray Oven Shield:**

When oven is clean, spray cavity with SH10 Oven Shield and wipe all interior surfaces. Place rack back in oven. Do not remove Oven Shield.

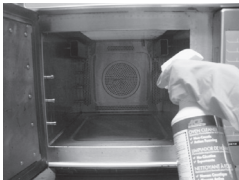

**3. Spray Oven Interior.** Remove baked on particles using a plastic scraper. Wear gloves and safety glasses. Spray oven door, sides and floor with CL10 Oven Cleaner. Allow to soak for 2-5 minutes.



#### **6. Clean Oven Exterior:**

Clean exterior door and other surfaces with clean cloth, sponge or composite pad, and warm soapy water.

### II. Weekly, Monthly or Quarterly Cleaning: Clean Air Filter



Filter is located below oven door.  
Turn screws counterclockwise and remove filter for cleaning.  
Wash filter using a sponge or composite pad and warm soapy water.  
Rinse and dry thoroughly.

#### Note:

- Remove food from oven at end of cycle.
- Wear protective rubber gloves when cleaning oven.
- Remove baked on particles using a plastic scraper.
- Avoid spraying caustic cleaners or those containing ammonia, phosphates, chlorine, sodium or potassium hydroxide (lye) directly on oven surfaces.
- Use only accessories that are both high temperature oven-safe and microwave-safe in the oven.
- DO NOT use a water-pressure type cleaning system.
- DO NOT cook foods contained in plastic wrap.
- DO NOT use metal foil in the oven. You may use drip tray accessory (DR10) to line oven.
- Metal pans with no more than 1 inch deep are acceptable. Assure pans do not contact oven or door surfaces during cooking.

# Before Calling for Service



## WARNING

To avoid electrical shock which can cause severe personal injury or death, do not remove outer case at any time. Only an authorized servicer should remove outer case.

PROBLEM	Possible Cause
Oven does not operate.	Confirm oven is plugged into dedicated circuit. Confirm oven is on grounded circuit. (Contact electrician to confirm) Check fuse or circuit breaker.
Oven operates intermittently or <b>HOT</b> shows in display.	Check air filter and discharge areas for obstructions.
If oven does not accept entries when pad is pressed.	Make sure oven is on and preheated. Open and close oven door. Press pad again.
If oven malfunctions or shows: <b>Error2</b> (example)	Oven control is equipped with a self-diagnostic system. Self-diagnostic system alerts you if there is an error or problem. When electronic control signals a problem, follow steps listed below. <ol style="list-style-type: none"> <li>1. Record number shown. (example of Error2 shown)</li> <li>2. Unplug oven, wait for 1 minute, and plug in oven.               <ul style="list-style-type: none"> <li>• Disconnecting electrical supply may eliminate service code. If failure continues, contact an authorized servicer.</li> </ul> </li> </ol>
Oven fan turns on while oven is not preheating or cooking.	Normal operation.