



LA9

STANDARD FEATURES

- › **FrameFree** canopy that maximises fully the visibility of displayed food
- › Four food display levels: three shelves plus base
- › Chrome wire shelving system that is height adjustable in 25mm increments and interchangeable between horizontal and tilted positions
- › **SlimLED** under-shelf LED strip lighting with 12V safety
- › Top venting to allow heat dissipation
- › Rear sliding doors on friction-free, low wear tracks (doors removable for cleaning)
- › Mounted on swivel and lockable castors allowing easy movement of cabinet

For Factory Options refer to page 60

For Cabinet Accessories refer to page 72

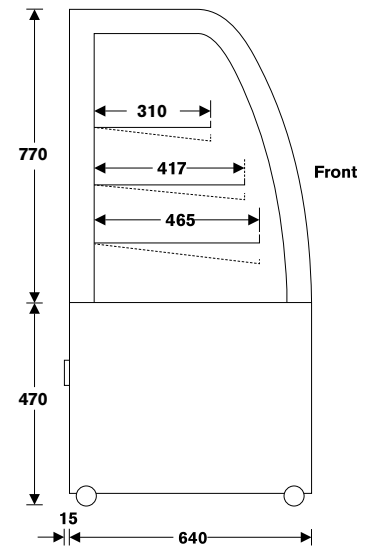
SIDE VIEW

LINCOLN: AMBIENT

This cabinet offers class to any ambient food offering. With its minimalist and stylish look, product stands out and tempts the customer.

Model	LA6	LA9	LA12	LA15	LA18	LA24
Length	600mm	900mm	1200mm	1530mm	1770mm	2370mm
Depth*	640mm	640mm	640mm	640mm	640mm	640mm
Height	1240mm	1240mm	1240mm	1240mm	1240mm	1240mm
Available Display Area	0.84m ²	1.34m ²	1.83m ²	2.4m ²	2.7m ²	3.7m ²
Power Connection	10A Plug	10A Plug	10A Plug	10A Plug	10A Plug	10A Plug

**Add extra 15mm for protruding control panel and switches*