

# *Professionnal induction hob*

## *GL 3000 DI - GL 3000 DIR*

EN

### User's guide

### For your induction hob



Dear Customer,

We would like to congratulate you on the purchase of your **ADVENTYS** product.

This one has been manufactured according to the very latest developments, using modern, safe electrical and electronic components.

Please take the time to read this user's guide before using this appliance.

Thank you for your confidence in our products.

# Contents

Technical information	18	Throughout this guide:  Indicates important Safety information
Declaration of Compliance and disposal of appliance	18	
Integrate your hob	19	
Using your induction hob	20	
How the hob works	21	
Cookware recommended	29	
How to maintain and care for your hob	30	
Small problems and their remedies	31	
Garantie	32	

## Technical specifications

<b>Model:</b>	GL 3000 DI/DIR
<b>Name:</b>	Integrated induction hob
<b>Matérials:</b>	Stainless steel and EZ
<b>Power:</b>	3000W depend of the version
<b>Electricity supply:</b>	single phase 230V +/-10% 50Hz
<b>Current:</b>	13A Max
<b>Controls</b>	-4 Capacitive touches and timer -9 Capacitive touches and timer -Knob command with light
<b>Dimensions</b>	W 376 X D 376 X H 173 mm
<b>Dimensions of the vitroceramic glass</b>	W 340 X D 340 X H 4 mm
<b>Dimensions of the inductor:</b>	210 mm
<b>Maximun weight allowed on the appliance:</b>	20 kg
<b>Net weight of the appliance:</b>	8 Kg

## Compliance and waste statement



This product complies with current EU directives. We certify this in the EU compliance statement. We can send you a copy of the compliance statement in question if required.

The packing materials in which this appliance is packed are recyclable. Please recycle them by disposing of them in the appropriate containers at your local facility. In so doing, you will be making a contribution to the protection of the environment.

At the end of its useful life, the appliance to be scrapped must be destroyed in accordance with the applicable national regulations that govern the elimination and recycling of waste.

We recommend you contact a company that specialises in waste disposal.

### WARNING :



To avoid all risks associated with the destruction of the appliance, ensure that it is disconnected from themains and that the mains cable is removed.

### PLEASE NOTE !

When destroying the appliance, local rules and the applicable regulations in your country or geographical zone must be adhered to.

# Using your hob safety

## The induction principle

After the appliance is switched on and a power level is selected, electronic circuits produce induced currents in the base of the pan which instantly transmits the heat produced to the foodstuffs. Cooking takes place with **practically no energy loss** with a very high energy output.

**If you have a heart pacemaker  
Or other active implant fitted :**

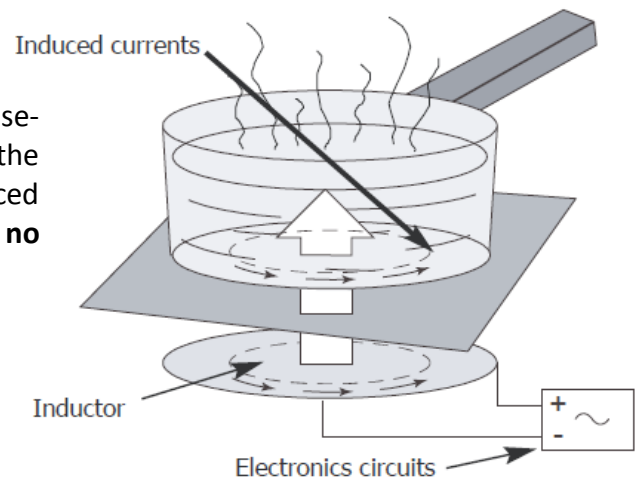

The functioning of the hob complies with the currently applicable norms concerning electromagnetic disturbance. Your induction cooking hob therefore fully meets the legal requirements (89/336/CEE directives). It has been designed not to cause disturbance to other electric appliances insofar as they also meet the requirements of the same regulations. Your induction hob emits magnetic fields in its immediate surroundings.

To avoid the possibility of interference between your cooking hob and a heart pacemaker, the latter must be designed to comply with the regulations that apply to it.

In this respect, we can therefore only guarantee the compliance of our own appliance. With regard to the compliance of a heart pacemaker or any eventual incompatibility, we recommend that you consult its manufacturer or your doctor.



If a crack appears in the surface of the glass, disconnect the appliance immediately from the mains supply to avoid the risk of electric shock. To do this, remove the fuses or operate the cut-off switch.

**Do not use your appliance again until the vitroceramic glass has been replaced.**

Only appropriate cookware should be placed on the hob. Do not put any other object on it, no matter what it is.

Ensure that the mains cable of any electric appliance that is plugged into a socket located in the immediate vicinity of the hob does not come into contact with the cooking zones.

**When cooking, never use aluminium foil and never place products that are wrapped in aluminium or frozen products in aluminium trays, on the hob. The aluminium will melt and will permanently damage your appliance.**

**Do not clean your hob with huge amounts of water. Use a little bit of household alcohol.**

**Do not use a steam cleaner.**

If the mains cable is damaged, it must be replaced by the manufacturer, their After Sales Service or a person with similar qualifications to avoid risk.

This appliance is not intended for use by anyone (including children) whose physical, sensory or mental capacities are reduced, or lacking experience or knowledge, unless they have been able to benefit from prior instructions as to the use of the appliance or supervision by a person who is responsible for their safety.

Supervise children to ensure that they do not play with the appliance.

Users should exercise caution if wearing items such as rings, watches or similar objects when using the appliance since these may heat up when positioned very close to the cooking surface.

Only use pans of the type and size recommended.

# Product integration

## Mechanical installation:

- 1) Realize a cut out of : 352 x 352 mm.
- 2) Put directly your product in your cut.

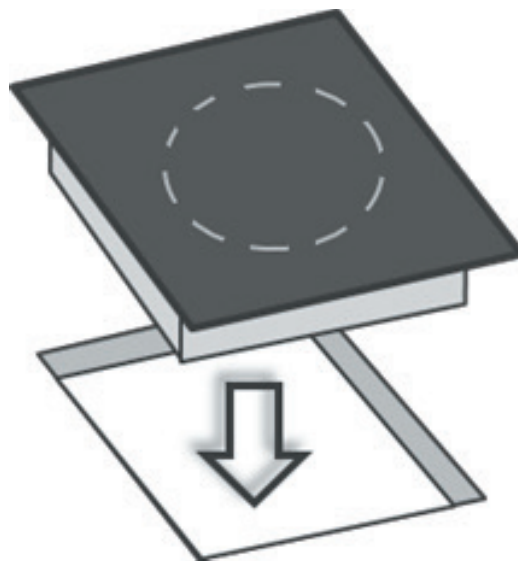

## 3) Connecting fresh air:

To obtain the best performances of the device, it is advisable to bring of the fresh air through a pipe that it is necessary to link on the present funnel under the device. The fresh air must be taken in the bottom of the piece of furniture, in the most convenient place.

# Product integration

## Control panel installation (capacitives touches or knobs) :

1) Realize a cut out following this plan :

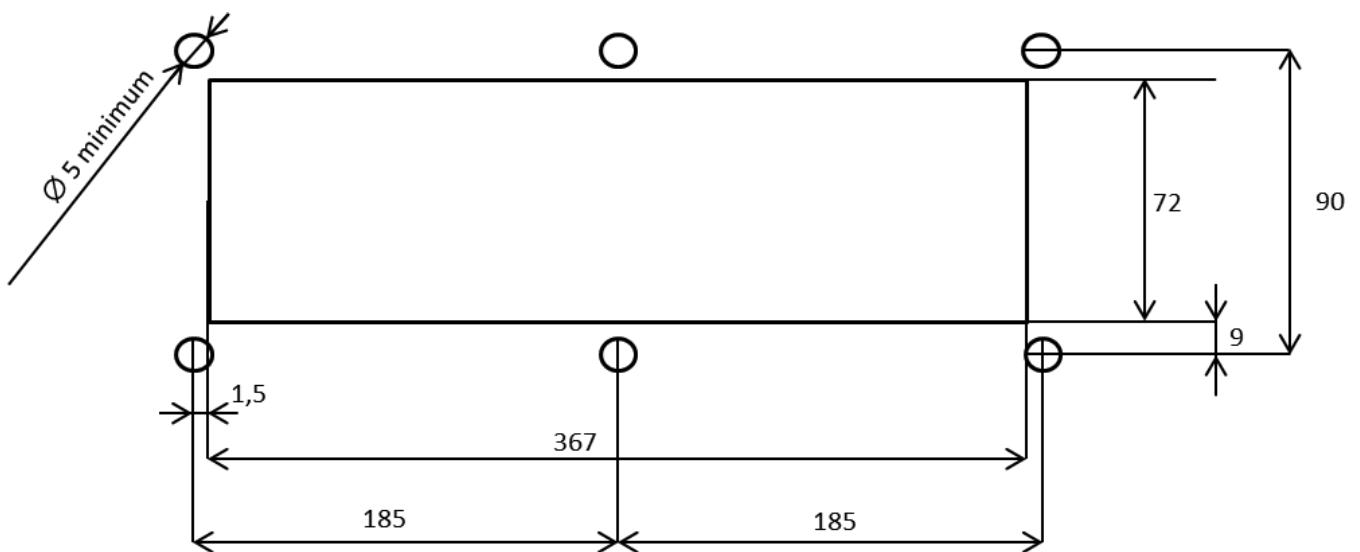

2) Add a silicone joint under the control panel.

3) Insert the control panel into the cut out.

4) Fix the control panel by tightening the bolts.

# Product integration

## 4 touches control panel :

### Option 1 : Built-in integration :

Realize a cut out of : 162 x 46 mm and put directly the control into the cut out.

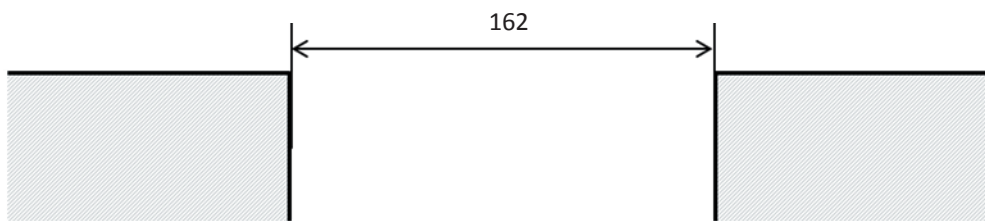

Drop your remote control into the counter.

(To improve the waterproofness, it is recommended to add a silicone joint under the glass).



Buit-in installation

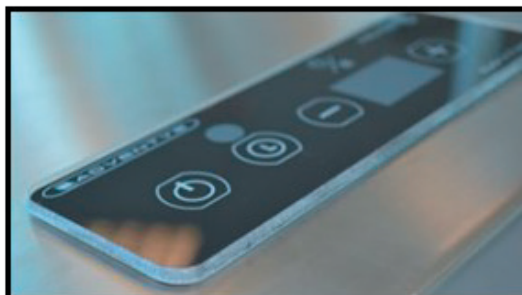

# Product integration

## Option 2 : Integrated installation :

Realize a cut out of : 176 x 62mm. You will have to create a fixation between the control and your structure.

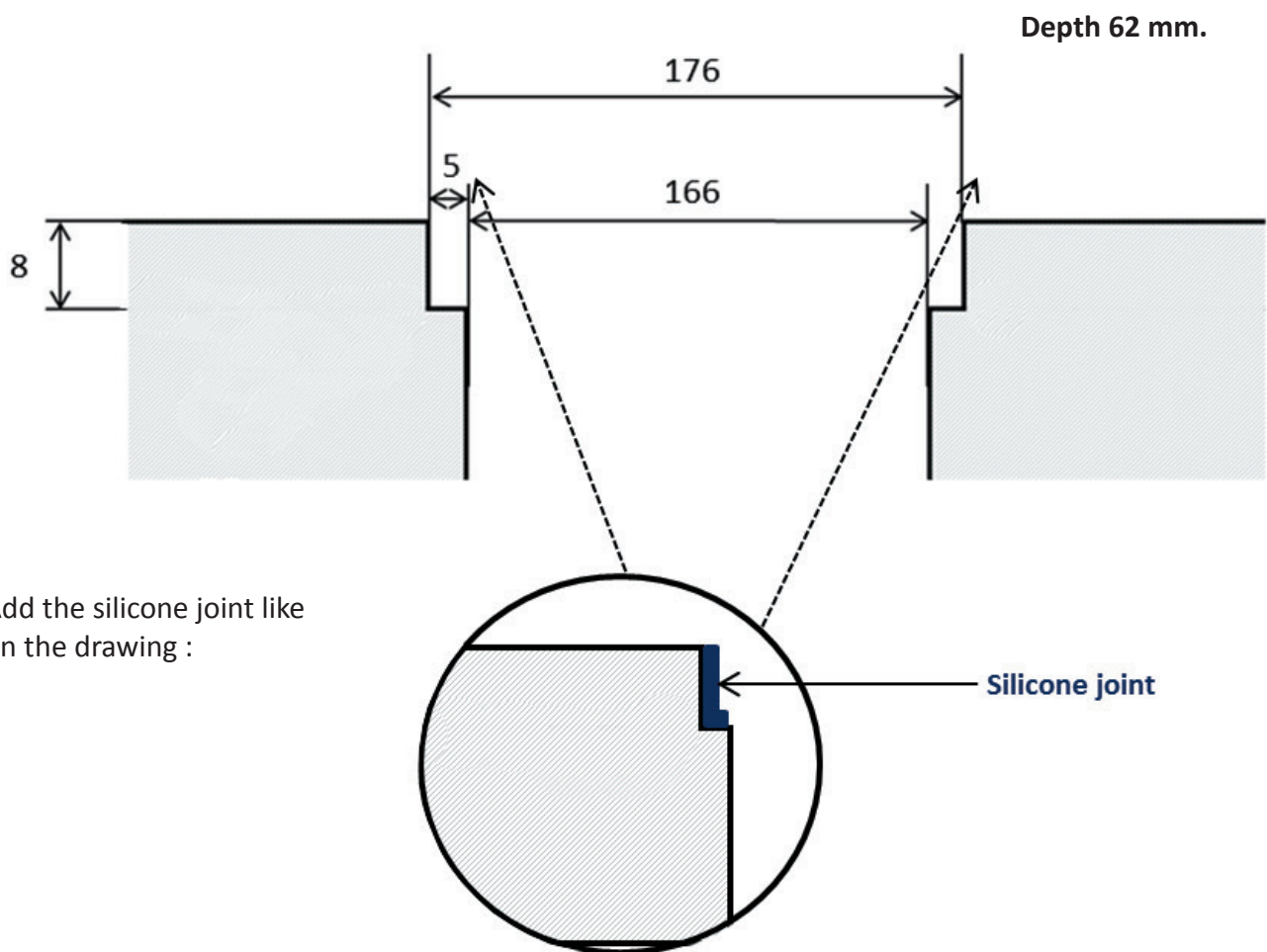

Add the silicone joint like on the drawing :

# Product integration

Insert the control panel & push it in to create a flushed finish :

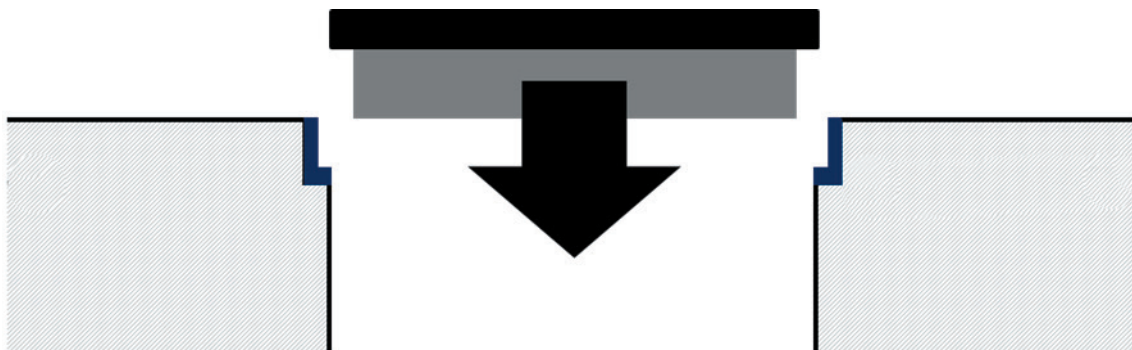

**Silicone joint and flushed finish**





## Integrated command

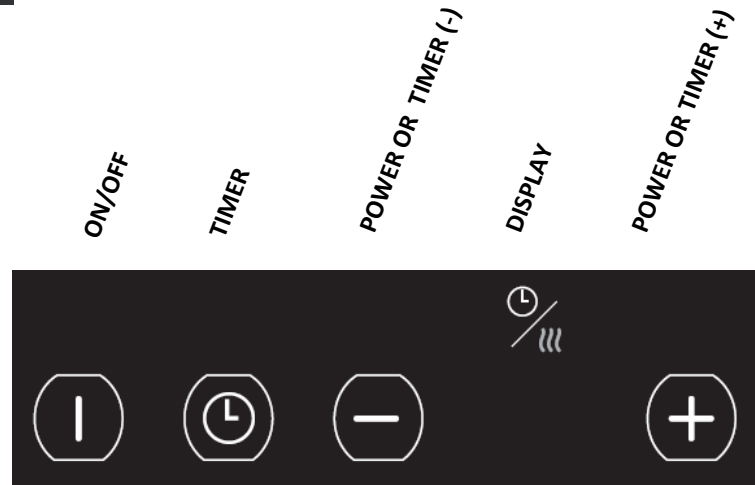
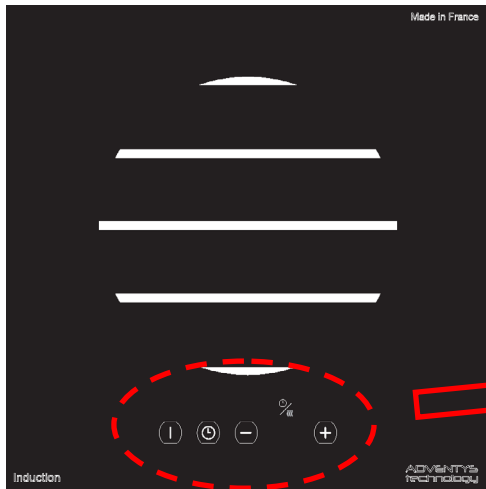

## Switch On the device

Connect the BLUE/ BROWN wire on NEUTRAL of the electric socket.  
Connect the GREY/BLACK wire on PHASE of the electric socket.  
Connect the GREEN and YELLOW wire on GROUND of the electric socket.



Connect your device on the adapted electric socket of a single-phase network 230 V, 50 Hz.

Press the « **ON/OFF** » touch to switch on the device. The value « 0 » displays on the indicator of power. Still no power is sent at that point.

Press either the power touches **(+)** to send power to the pan. The power display indicates the power level set into the pan.

## Switch Off the device

Press the « **ON/OFF** » touch to switch off the product. The power is cut and the display turns off.

After removing the pan from the cooktop, an « H » (stands for « Hot ») might be flashing on the display as long as the temperature on the vitroceramic glass exceeds 60°C.

## Timer setting

For activate the timer press the **(timer)** touch. The timer light switch on and there is « **ti** » message on the display for 3 second.

Press **(+)** and **(-)** to adjust the timer. The duration of the timer is between 1 and 99 minutes.

The end of the timer forces the stop of the power. The product is automatically switched off. To stop the sound emitted at the end of the timer, a brief press on any touches is enough.

For desactivate the timer press the **(timer)** touch. The timer light switch off and there is « **te** » message on the display for 3 second.

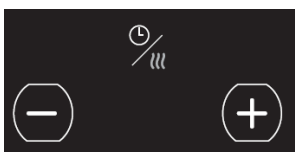

# Operating instruction

## Power setting

Place an induction-friendly pan on the cooktop to start using the product. The power display indicates the level of temperature. Make sure the pan is not empty.

To adjust the temperature level press **(+)** or **(-)** POWER.

	<b>GL 650 DI / DIR</b>
<b>Settings</b>	<b>Temperature (°C)</b>
1	40
2	50
3	55
4	60
5	65
6	70
7	75
8	80
9	90

As soon as the pan is removed from the cooking zone, the display indicates the absence of the pan by a blinking. There is close to no consumption of power. If the display flashes when the pan recovers the cooking zone, it means that the material of the pan is not compatible with the induction technologie.

## Display of specific message

The device is extremely safe. It makes a permanent control of the values of temperature and other electric parameters to guarantee to the user the best level of performance and safety at every moment.

A flashing error code « **Fx** » can appear on the display to warn about a malfunctioning.

The code error flashing is effective as long as the user doesn't stop the device manually unplug and replug the unit, and then relaunch the device using the « **On/Off** » touch.

If a code error becomes permanent without having the possibility of cancelling it by trying to relaunch the device, it is advised to get in touch with the after-sales service specified by the retailer of the product.

## Detached command

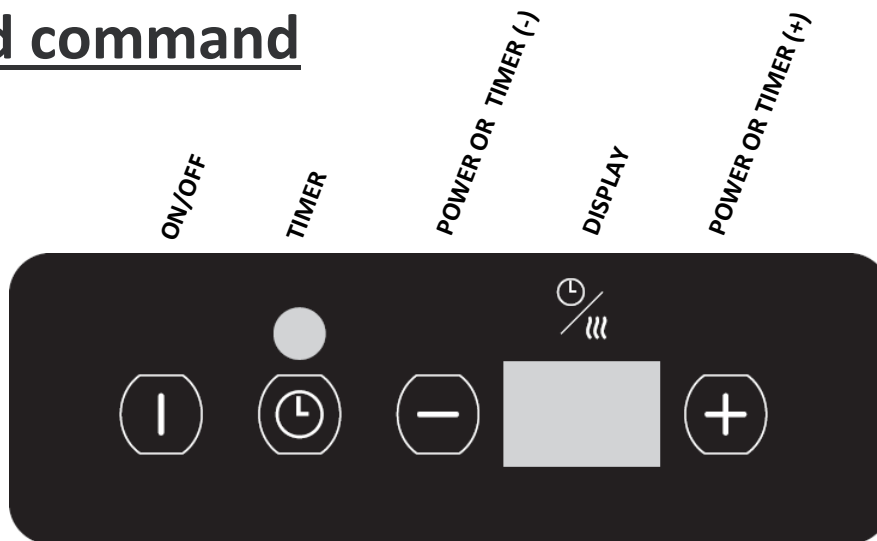

## Switch On the device

Connect the BLUE/ BROWN wire on NEUTRAL of the electric socket.  
Connect the GREY/BLACK wire on PHASE of the electric socket.  
Connect the GREEN and YELLOW wire on GROUND of the electric socket.



Connect your device on the adapted electric socket of a single-phase network 230 V, 50 Hz.

Press the « **ON/OFF** » touch to switch on the device. The value « 0 » displays on the indicator of power. Still no power is sent at that point.

Press either the power touches **(+)** to send power to the pan. The power display indicates the power set into the pan.

## Switch Off the device

Press the « **ON/OFF** » touch to switch off the product. The power is cut and the display turns off.

After removing the pan from the cooktop, an « H » (stands for « Hot ») might be flashing on the display as long as the temperature on the vitroceramic glass exceeds 60°C.

## Timer setting

For activate the timer press the **(timer)** touch. The timer light switch on and there is « **ti** » message on the display for 3 second.



Press **(+)** and **(-)** to adjust the timer. The duration of the timer is between 1 and 99 minutes.

The end of the timer forces the stop of the power. The product is automatically switched off. To stop the sound emitted at the end of the timer, a brief press on any touches is enough.

For desactivate the timer press the **(timer)** touch. The timer light switch off and there is « **te** » message on the display for 3 second.

## Cookware Recommended

Your induction hob is able to recognize the majority of pans and recipients.

**Testing a pan:** place the pan on the cooking zone with a power level set : **if indicator stays on**, your pan is **compatible**, if it **flashes**, your pan **has not been recognised and cannot be used**.

You can also test with the aid of a magnet: if it "sticks" to the base of the pan, then the pan is compatible with induction technology.

**Induction-compatible pans are:**

- **enamelled steel pans** with or without a nonstick coating.
- **stainless-steel pans** designed for induction. Most stainless steel pans are suitable if they pass the pan test.
- **cast-iron pans** with or without an enamelled base.
- **aluminium pans with special bases.**

### • NOTE

Pans made from glass, ceramic material, clay, aluminium (without special pan base), and copper, as well as certain non-magnetic stainless steels are not compatible with induction cooking. The indicator for the power level selected will flash to inform you of this.



Containers made of plastic must not be placed on hot surfaces

## How to maintain and care for your hob

**Avoid shocks** when handling the pans.

The glass surface is very strong, however it is not unbreakable.

**Avoid rubbing** the pans over the surface of the appliance.

**Centre** your pan on the induction cooking zone.

**Do not leave an empty pan** on the induction zone.

**Do not pre-heat** foodstuffs on the **highest power setting** if you are using a pan with an anti-stick coating (of the teflon type) without or with a tiny amount of cooking fat or oil.

**Do not heat an unopened tin can**, as it might burst.

**All these defects that do not cause a non operation or inability to use are not covered by the guarantee.**



**Do not leave metal cooking utensils**, lids, knives or any other metal objects on the inductioncooking zone. These objects are liable to heat up if they remain too close to the magnetic field generated by the induction cooking zone.

## How to maintain and care for your hob

Clean approximately every week with soapy water the filter placed under your device (or put it in the dishwasher). Put it back very dry before any use. This filter protects your device from dust and fats.

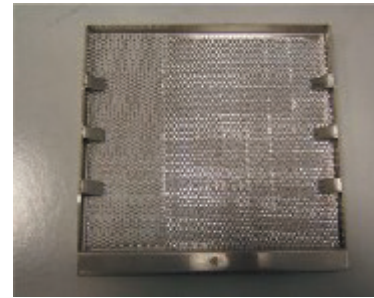

Your device is cleaned easily, to help you, here is some advice:

Type of spots	How to proceed	Use
Slight	Dilute well the zone to clean with hot water then wipe.	Sanitary sponges
Accumulation of recooked spots	Dilute well the zone to clean with hot water, use a special scraper for glass to rough-hew, finish with the scraper side of a sanitary sponge, then wipe.	Sanitary sponges special scraper for glass
Haloos and tracks of limestone	Apply some hot spirit vinegar to the spot, let act, wipe with a soft cloth. Use a domestic product.	Special vitroceramic glass dough
Inlays following the overflowing of sugar, aluminium or molten plastic	Apply to the surface a special product for vitroceramic glass, rather containing some silicone (protective effect).	Special vitroceramic glass product

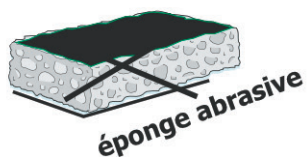

## Small problems and their remedies

FR

If you think that your hob is not functioning correctly ..... this does not necessarily mean that a fault has occurred. Please verify the following in all cases :

EN

PT

YOU NOTICE THAT ...	POSSIBLE CAUSES	WHAT YOU CAN DO
When putting into service, a bright display appears	Regular functioning	NOTHING: everything is normal
When putting into service, your installation short-circuits	The connection of you device is defective	Verify your connection or the conformity of the connection
The ventilation continues a few minutes after stopping the device	Cooling of the device	It's normal
The device doesn't work. The display on the casing stays off	The device is not supplied. The supply or the connection is defective	Inspect fuses and the circuit breaker of your electric installation
« F- » appears on the display	There is a touch activated permanently on the control keyboard	If the default doesn't disappear, call the after-sales service
« F7 » appears on the display	Electric circuits are over heating	Inspect the ventilation of the device and check if it is operational
The device doesn't work, another code appears on the display	Electric circuits doesn't work well	Call the after-sales service
After switching on the device and starting the cooking zone, the selected indicator continues to flash	The pan you are using is not compatible with the induction technology or is of a diameter smaller than 12 cm	See « Cookware Recommended section »
Pan makes noise while cooking	It's a vibration generated by the circulation of the current in the pan	This phenomenon is normal with some type of pans. There is no danger
The device releases a smell during the first cookings	New device	Run the cooking during half an hour with a pan full of water

**If the vitroceramic hob suffers a breakage, split or crack, no matter how small, disconnect the appliance immediately and contact After-Sales Service.**

# Garantee

Keep the proof of purchase to use the guarantee service of your product.

Any modification such as drilling, welding, criimping, clinching, etc., is not permitted and is not covered by the manufacturer's warrenty.

Any wrong modification or installation, which does not respect ADVENTYS' standards, is not covered by the manufacturer's warranty and will be permanently suspended.

The guarantee is subject to the non-modification of the product and its mechanical and electrical specifications. Opening the product cancels any form of warranty.

Any defects in appearance caused by the use of abrasive products or friction of cookware on the ceramic glass hob that does not result in a non-functioning or inability to use the appliance is not covered in the guarantee. The vitroceramic glass and the casing are not subject to warranty.

ANY REPAIRS MUST BE CARRIED OUT BY A QUALIFIED TECHNICIAN APPROVED BY ADVENTYS.

Only the distributors of our brand:

- **KNOW YOUR APPLIANCE PERFECTLY AND HOW IT WORKS.**
- **FULLY APPLY OUR METHODS OF ADJUSTEMENT, MAINTENANCE AND REPAIRS.**
- **USE ONLY ORIGINAL SPARE PARTS.**

In case of a claim or if you wish to order spare parts from your distributor, please specify the full reference numbers of your appliance (appliance type and serial number). This information appears on the plate fixed under the metal casing of the appliance.

The descriptions and characteristics given in this booklet are for information purposes only and do not imply commitment from the manufacturer. Concerned about the quality of our products, we reserve the right to carry out necessary changes or improvements without prior notice.

Original spare parts: ask your retailer for certified original spare parts during a maintenance operation.



Made In France