

Waldorf[®]

800 SERIES

Installation and Operation Manual

Gas Range Static Oven

RN8410G

RNL8410G

RN8820G

RNL8820G



Date Purchased

Serial Number

Dealer

Service Provider

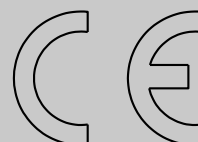

For use in GB, IE & DK

MANUFACTURED BY

Moffat Limited

Christchurch
New Zealand

INTERNATIONAL CONTACTS

AUSTRALIA

Moffat Pty Limited

Web: www.moffat.com.au
E.Mail: vsales@moffat.com.au
Main Office: (tel) +61 (03) 9518 3888
(fax) +61 (03) 9518 3833
Service: (tel): 1800 622 216
Spares: (tel): 1800 337 963
Customer Service: (tel): 1800 335 315
(fax): 1800 350 281

CANADA

Serve Canada

Web: www.servecanada.com
E.Mail: info@servecanada.com
Sales: (tel): 800 551 8795 (Toll Free)
Service: (tel): 800 263 1455 (Toll Free)

NEW ZEALAND

Moffat Limited

Web: www.moffat.co.nz
E.Mail: sales@moffat.co.nz
Main Office: (tel): 0800 663328

UNITED KINGDOM

Blue Seal

Web: www.blue-seal.co.uk
E.Mail: sales@blue-seal.co.uk
Sales: (tel): +44 121 327 5575
(fax): +44 121 327 9711
Spares: (tel): +44 121 322 6640
(fax): +44 121 327 9201
Service: (tel): +44 121 322 6644
(fax): +44 121 327 6257

UNITED STATES

Moffat

Web: www.moffat.com
Sales: (tel): 800 551 8795 (Toll Free)
(tel): +1 336 661 1556
(fax): +1 336 661 9546
Service: (tel): 800 858 4477 (Toll Free)
(tel): +1 336 661 1556
(fax): +1 336 661 1660

REST OF WORLD

Moffat Limited

Web: www.moffat.co.nz
E.Mail: export@moffat.co.nz

The reproduction or copying of any part of this manual by any means whatsoever is strictly forbidden unless authorized previously in writing by the manufacturer.

In line with policy to continually develop and improve its products, Moffat Ltd. reserves the right to change the specifications and design without prior notice.

© Copyright Moffat Ltd. November 2011.

Waldorf Gas Static Oven Range

RN(L)8410G	Gas Range Static Oven	- 600 mm.
RN(L)8820G	Gas Range Double Static Oven	- 1200 mm.

Introduction	2
Specification	3
Model Numbers Covered in this Specification	
General	
Gas Supply Requirements	
Gas Connection	
Dimensions	5
Installation	6
Installation Requirements	
Unpacking	
Location	
Clearances	
Assembly	
Gas Connection	
Commissioning	
Operation	10
Operation Guide	
Description of Controls	
Open Burners	
Griddles	
Oven Pilot Ignition	
Oven - Main Burner / Thermostat	
Turning the Oven to 'Stand-By' (Pilot 'ON' Only)	
Oven 'Shut Down'	
Cleaning and Maintenance	14
General	
After Each Use	
Daily Cleaning	
Weekly Cleaning	
Periodic Maintenance	
Fault Finding	18
Gas Conversion and Specifications	19
Conversion Procedure	
Gas Specifications	
Replacement Parts List	23

Introduction

We are confident that you will be delighted with your WALDORF GAS RANGE STATIC OVEN and it will become a most valued appliance in your commercial kitchen.

To ensure you receive the utmost benefit from your new Waldorf appliance, there are two important things you can do.

Firstly:

Please read the instruction book carefully and follow directions given. The time taken will be well spent.

Secondly:

If you are unsure of any aspect of the installation, instructions or performance of your appliance, contact your WALDORF dealer promptly. In many cases a phone call could answer your question.

CE Only:

These instructions are only valid if the country code appears on the appliance. If the code does not appear on the appliance, refer to the supplier of this appliance to obtain the technical instructions for adapting the appliance to the conditions for use in that country.



Warning

IMPROPER INSTALLATION, ADJUSTMENT, ALTERATION, SERVICE OR MAINTENANCE CAN CAUSE PROPERTY DAMAGE, INJURY OR DEATH. READ THE INSTALLATION, OPERATING AND MAINTENANCE INSTRUCTIONS THOROUGHLY BEFORE INSTALLING OR SERVICING THIS APPLIANCE.



Warning

INSTRUCTIONS TO BE FOLLOWED IN THE EVENT THE USER SMELLS GAS ARE TO BE POSTED IN A PROMINENT LOCATION. THIS INFORMATION SHALL BE OBTAINED BY CONSULTING THE LOCAL GAS SUPPLIER.



Warning

GREAT CARE MUST BE TAKEN BY THE OPERATOR TO USE THE EQUIPMENT SAFELY TO GUARD IT AGAINST RISK OF FIRE.

- THE APPLIANCE MUST **NOT** BE LEFT ON UNATTENDED.
 - IT IS RECOMMENDED THAT A REGULAR INSPECTION IS MADE BY A COMPETENT SERVICE PERSON TO ENSURE CORRECT AND SAFE OPERATION OF YOUR APPLIANCE IS MAINTAINED.
 - **DO NOT** STORE OR USE GASOLINE OR OTHER FLAMMABLE VAPOURS OR LIQUIDS IN THE VICINITY OF THIS OR ANY OTHER APPLIANCE.
 - **DO NOT** SPRAY AEROSOLS IN THE VICINITY OF THIS APPLIANCE WHILE IT IS IN OPERATION.
-



Caution

- This appliance is for professional use and is only to be used by qualified persons.
 - **Only authorised service persons are to carry out installation, servicing or gas conversion operations.**
 - Components having adjustments protected (e.g. paint sealed) by the manufacturer should not be adjusted by the user / operator.
 - **DO NOT** operate the appliance without the legs supplied fitted.
-

Model Numbers Covered in this Specification

- RN[1]8410G [2] Gas Range Static Oven + 4 Open Burners.**
- RN[1]8413G [2] Gas Range Static Oven + 2 Open Burners + 300 mm Griddle.**
- RN[1]8416G [2] Gas Range Static Oven + 600 mm Griddle.**

- RN[1]8820G [2] Gas Range Double Static Oven + 8 Open Burners.**
- RN[1]8823G [2] Gas Range Double Static Oven + 6 Open Burners + 300 mm Griddle.**
- RN[1]8826G [2] Gas Range Double Static Oven + 4 Open Burners + 600 mm Griddle.**
- RN[1]8829G [2] Gas Range Double Static Oven + 2 Open Burners + 900 mm Griddle.**

NOTE:

[1]: - Back Options;

- - Standard Models.
- L - Low Back Models.

[2] - Open Burner Options;

- F - With Flame Failure Protection.
- PF - With Pilot and Flame Failure Protection.

NOTE: The RN8820G consists of two ovens with a 1200 mm wide Cook Top.

General

A heavy duty, general purpose gas range created for compact modular kitchens. It has a high option Cook Top / Griddle arrangement and is available on industrial adjustable feet or on robust rollers. Open Burners are available in either 'PF' (Pilot and Flame Failure) or 'F' (Flame Failure Only) options. Open Burner and Griddle options are fitted with individual flame failure for each open burner. Griddles are fitted with pilot, flame failure and piezo ignition as standard. Easy clean stainless steel external finish. The oven has pilot and flame failure with piezo ignition.

Specifications

Gas Supply Requirements

- Non CE Only (Australia / New Zealand):

	Natural Gas	LP Gas (Propane)
Input Rate (N.H.G.C.) - each Open Burner	28 MJ/hr (26,538 Btu/hr)	28 MJ/hr (26,538 Btu/hr)
- each 300 mm Griddle Section	21 MJ/hr (19,900 Btu/hr)	21 MJ/hr (19,900 Btu/hr)
- Oven	24 MJ/hr (22,748 Btu/hr)	24 MJ/hr (22,748 Btu/hr)
Supply Pressure	1.13 - 3.40 kPa (4.5" - 13.5" w.c.)	2.75 - 4.50 kPa (11" - 18.0" w.c.)
Burner Operating Pressure	0.95 kPa (*) (3.7" w.c.)	2.6 kPa (*) (10" w.c.)
Gas Connection	3/4" B.S.P. Male	

- CE Only:

Appliance Classification

Category: II_{2H3P} (20, 30 / 37).

Flue Type: A₁.

		Natural Gas (G20)			Propane (G31)		
		Open Burner (each)	Griddle (each 300mm section)	Oven	Open Burner (each)	Griddle (each 300mm section)	Oven
Heat Input (nett)	Nominal	6.5 kW	5.5 kW	6.5 kW	6.5 kW	5.5 kW	6.0 kW
	Reduced	1.75 kW	1.85 kW	1.1 kW	1.75 kW	1.95 kW	1.05 kW
Gas Rate (nett)	Nominal	0.69 m ³ /hr	0.58 m ³ /hr	0.69 m ³ /hr	0.51 kg/hr	0.43 kg/hr	0.47 kg/hr
	Reduced	0.19 m ³ /hr	0.20 m ³ /hr	0.12 m ³ /hr	0.14 kg/hr	0.15 kg/hr	0.09 kg/hr
Supply Pressure		20 mbar			30 / 37 mbar		
Burner Operating Pressure		9.5 mbar (*)			26 mbar (*)		
Gas Connection		3/4" B.S.P. Male					

- * Measure burner operating pressure at the manifold test point with two burners operating at full setting. Operating pressure is ex-factory set, through appliance regulator and is not to be adjusted, apart from when converting between gases, if required. (Refer to 'Gas Conversion' section for details).

Gas Connection

Gas supply connection point is located at rear of appliance, approximately 130mm from right hand side, 32mm from rear and 655mm from floor and is reached from beneath appliance. (Refer to 'Dimensions' section).

Connection is 3/4" BSP male thread.

RN(L)8410G

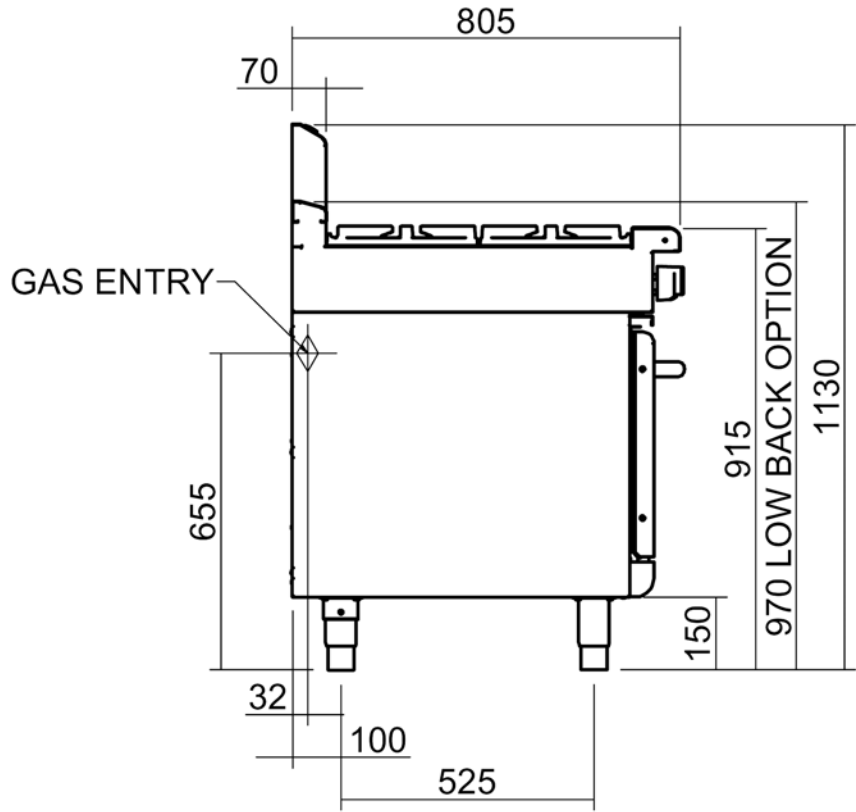
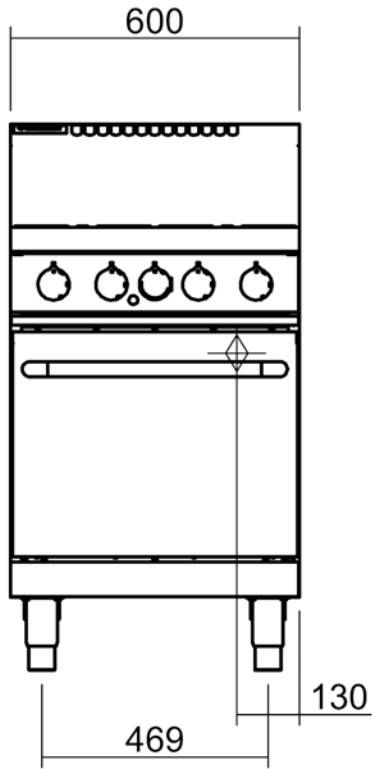

Gas Cooktop Options

RN(L)8410G

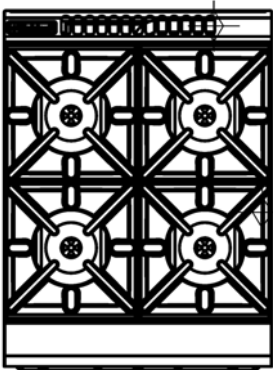

RN(L)8413G

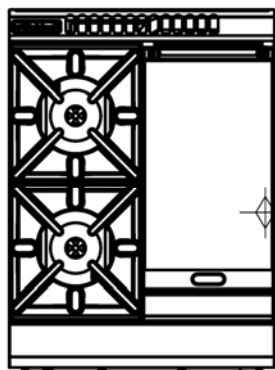

RN(L)8416G

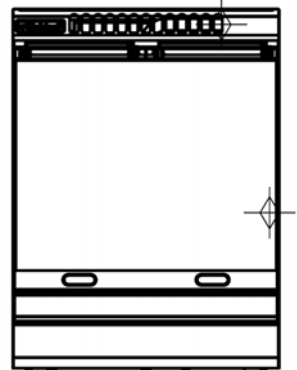

Dimensions

RN(L)8820G

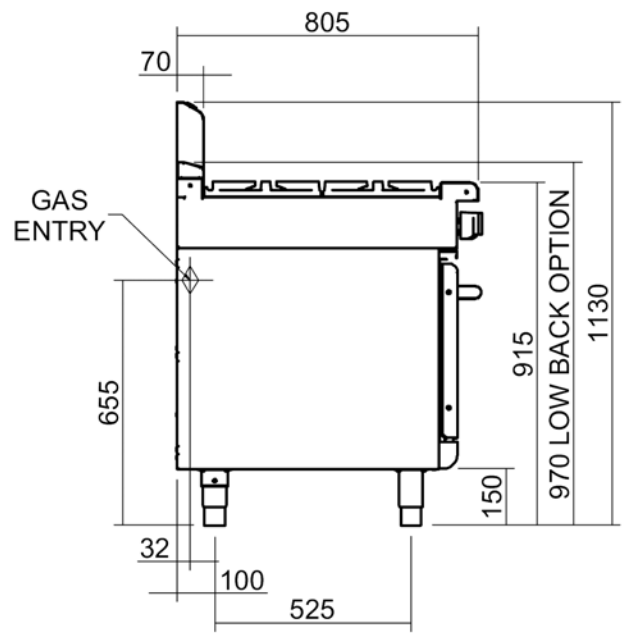
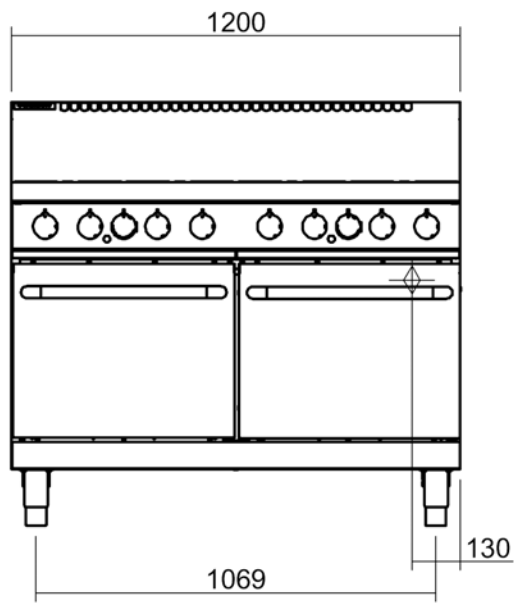

Gas Cooktop Options

RN(L)8820G

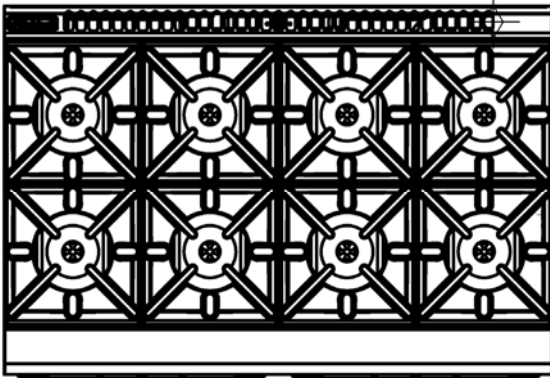

RN(L)8823G

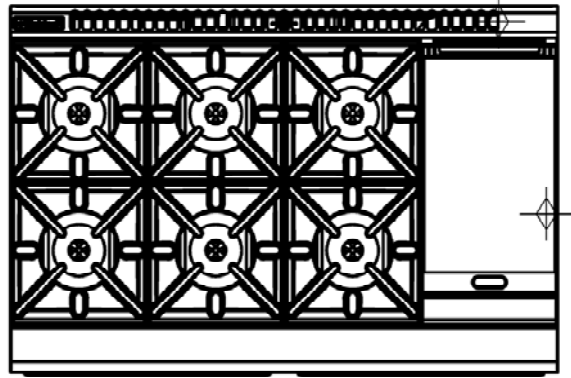

RN(L)8826G

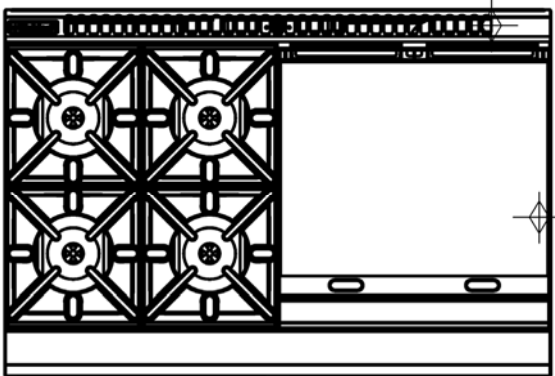

RN(L)8829G

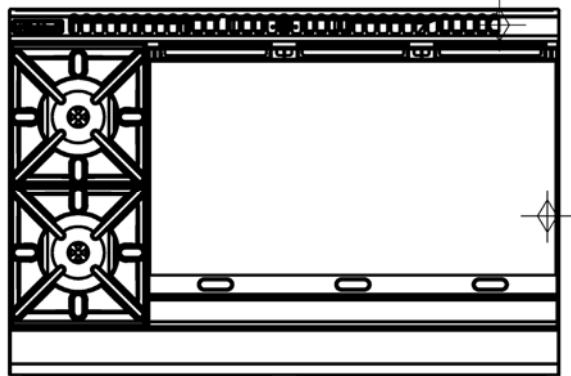

Installation Requirements

NOTE:

- It is most important that this appliance is installed correctly and that operation is correct before use. Installation shall comply with local gas and health and safety requirements.
- This appliance shall be installed with sufficient ventilation to prevent the occurrence of unacceptable concentrations of health harmful substances in the room, the appliance is installed in.

Waldorf Ovens are designed to provide years of satisfactory service, and correct installation is essential to achieve the best performance, efficiency and trouble-free operation.

This appliance must be installed in accordance with National installation codes and in addition, in accordance with relevant National / Local codes covering gas and fire safety.

AUSTRALIA:	- AS5601	- Gas Installations.
NEW ZEALAND:	- NZS5261	- Gas Installation.
UNITED KINGDOM:	- Gas Safety (Installation & Use) Regulations 1998.	
	- BS6173	- Installation of Catering Appliances.
	- BS5440 1 & 2	- Installation Flueing & Ventilation.
IRELAND:	- IS 820	- Non - Domestic Gas Installations.

Installation must be carried out by authorised persons only. Failure to install equipment to relevant codes and manufacturer's specifications shown in this section will void the warranty.

Components having adjustments protected (e.g. paint sealed) by manufacturer are only to be adjusted by an authorised service agent. They are not to be adjusted by the installation person.

Unpacking

- Remove all packaging and transit protection from appliance including all protective plastic coating from exterior stainless steel panels.
- Check equipment and parts for damage. Report any damage immediately to the carrier and distributor.
- Report any deficiencies to distributor who supplied the appliance.
- Check that available gas and electrical supply is correct to that shown on rating plate located on front right hand corner of bottom sill.

Location

1. Installation must allow for a sufficient flow of fresh air for the combustion air supply.

Combustion Air Requirements:		
	RN8410G	RN8820G
Natural Gas (G20)	32 m ³ /hr	63 m ³ /hr
LPG / Propane (G31)	33 m ³ /hr	65 m ³ /hr

2. Installation must include adequate ventilation means, to prevent dangerous build up of combustion products.
3. Never directly connect a ventilation system to appliance flue outlet.
4. Position appliance in its approximate working position.
5. All air for burner combustion is supplied from beneath appliance. Legs must always be fitted and no obstructions placed under or around base of appliance, as obstructions will cause incorrect operation and / or failure of appliance.

NOTE: Do not obstruct or block appliances flue. Never directly connect a ventilation system to appliance flue outlet.

Installation

Clearances

NOTE: Only non-combustible materials can be used in close proximity to this appliance.

	Combustible Surface	Non Combustible Surface
Left / Right hand side	250 mm (*)	0 mm
Rear	100 mm	0 mm

* Side clearances can be 50mm when adjacent surface is at least 100mm below cooking surface.

Assembly



Caution

- **This appliance is for professional use and is only to be used by qualified persons.**
- **Only authorised service persons are to carry out installation, servicing or gas conversion operations.**

NOTE:

- **All Models are delivered completely assembled. No further assembly is required.**
- **This appliance is fitted with adjustable feet to enable appliance to be positioned securely and level. This should be carried out on completion of gas connection. Refer to 'Gas Connection' section.**

Optional Accessories (Refer to Replacement Parts List)

- Rear Roller Kit. For installation details, refer to instructions supplied with each kit.
- Plinth Kit. For installation details, refer to instructions supplied with each kit.

1. Check all feet (or castors) are securely fitted.
2. Adjust feet to make oven range steady and level.

Gas Connection

NOTE: ALL GAS FITTING MUST ONLY BE CARRIED OUT BY AN AUTHORISED PERSON.

1. Waldorf Ranges do not require an electrical connection, as they function totally on gas supply only.
2. It is essential that gas supply is correct for appliance being installed and that adequate supply pressure and volume are available. The following checks should be made before installation:-
 - a. **Gas Type** the appliance has been supplied for is shown on coloured stickers located above gas connection and on rating plate. Check that this is correct for the gas supply the appliance is being installed for. Gas conversion procedure is shown in this manual.
 - b. **Supply Pressure** required for this appliance is shown in 'Specifications' section of this manual. Check gas supply to ensure adequate supply pressure exists.
 - c. **Input Rate** of this appliance is shown on Rating Plate and in 'Specifications' section of this manual. Input rate should be checked against available gas supply line capacity. **Particular note should be taken if appliance is being added to an existing installation.**



NOTE: It is important that adequately sized piping runs directly to connection joint on appliance with as few tees and elbows as possible to give maximum supply volume.

3. Fit gas regulator supplied, into gas supply line as close to appliance as possible.

NOTE: Gas pressure regulator provided with this appliance is convertible between Natural Gas and LPG as shown in 'Gas Conversion Section' in this manual.
Ensure regulator is converted to correct gas type that appliance will operate on.
Regulator outlet pressure is fixed ex-factory for gas type that regulator is converted to and it is **NOT to be adjusted.**

Regulator connections are $\frac{3}{4}$ " BSP female.

Connection to the appliance is $\frac{3}{4}$ " BSP male.

(Refer to 'Specifications' section for gas supply location dimensions).

NOTE: A Manual Isolation Valve must be fitted to the individual appliance supply line.

4. Correctly locate appliance into its final operating position and using a spirit level, adjust legs so that appliance is level and at correct height.
5. Connect gas supply to appliance. A suitable joining compound which resists breakdown action of LPG must be used on every gas line connection, unless compression fittings are used.
6. Check all gas connections for leakages using soapy water or other gas detecting equipment.



Warning

DO NOT USE A NAKED FLAME TO CHECK FOR GAS LEAKAGES.

7. Check gas operating pressure is as shown in the 'Specifications' section.

NOTE: Measure burner operating pressure at manifold test point with two burners operating at 'Full' setting.

8. Turn 'Off' mains gas supply and bleed gas out of appliance gas lines.
9. Turn 'On' gas supply and appliance.
10. Verify operating pressure remains correct.

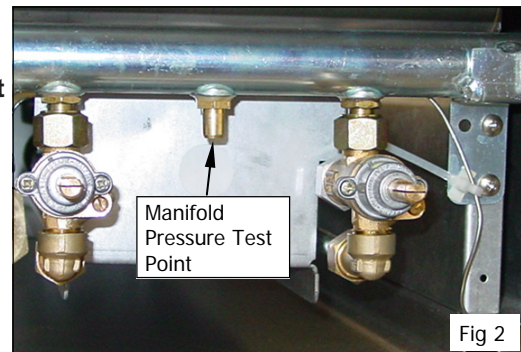

Fig 2

Commissioning

1. Before leaving a new installation;
 - a. Check the following functions in accordance with operating instructions specified in 'Operation' section of this manual.
 - Lighting the Griddle.
 - Light the Open Burners. (F - Flame Failure Option).
 - Light the Open Burners. (PF - Pilot and Flame Failure Option).
 - Check the Low Fire burner operation.
 - Oven Pilot Ignition.
 - Oven Main Burner / Thermostat.
 - Turning the Oven to 'Stand-By' Mode.
 - Oven 'Shut Down'.
 - b. Ensure operator has been instructed in areas of correct lighting, operation, and shutdown procedure for appliance.
2. This manual must be kept by owner for future reference, and a record of ***Date of Purchase, Date of Installation*** and ***Serial Number of Unit*** recorded and kept with this manual. (These details can be found on Rating Plate attached to bottom right hand corner of bottom sill. Refer to 'Gas Connection' section).

NOTE: If it is not possible to get appliance to operate correctly, shut off gas supply and contact supplier of this appliance.

Operation

Operation Guide



Caution

- This appliance is for professional use and is only to be used by qualified persons.
- Only authorised service persons are to carry out installation, servicing or gas conversion operations.
- Components having adjustments protected (e.g. paint sealed) by the manufacturer should not be adjusted by the user / operator.

1. Waldorf appliances have been designed to provide simplicity of operation and 100% safety protection.
2. Improper operation is almost impossible, however bad operation practices can reduce the life of the appliance and produce a poor quality product. To use this appliance correctly please read the following sections carefully:-

- Lighting the Open Burners (F - Flame Failure Option).
- Lighting the Open Burners (PF - Pilot and Flame Failure Option).
- Lighting the Griddle.
- Oven Pilot Ignition.
- Oven Main Burner / Thermostat.
- Turning Oven to 'Stand-By' (Pilot 'ON' Only).
- Oven 'Shut-Down'.

Description of Controls



Fig 3

Gas Control Knobs (When Fitted with Griddle Option Only)

○ OFF Position

★ PILOT Burner

△ HIGH Flame

△ LOW Flame

Griddle Piezo Igniter (When fitted with Griddle Option Only)

Gas Control Knobs (Open Burner Option)

○ OFF Position

△ HIGH Flame

△ LOW Flame

Gas Control Knob (Oven)

○ OFF Position

★ PILOT Burner

Temperature
Graduations 130°C
to 270°C

Oven Piezo Igniter (One per Oven)

Open Burners

NOTE: Only cooking pans from size Ø 150 mm to Ø 420 mm are suitable for use on these open burners.

Flame Failure Option (F-Models)

Lighting the Open Burners

Flame Failure Protection is incorporated for each burner by way of a thermo-electric system which will shut off gas supply to that burner if burner goes out, so that un-burnt gas is not expelled.

- a. Select burner required, depress and turn corresponding gas control knob anti-clockwise to 'HIGH' position.
- b. With gas control knob depressed, manually light burner.
- c. Release gas control knob approximately 10-20 seconds after lighting burner.
- d. Burner should stay alight - if not, repeat Steps (a to (c above.
- e. To achieve simmer control, depress gas control knob and rotate between 'HIGH' and 'LOW' positions to achieve temperature required.

Turning 'OFF' the Open Burners

- a. When main burner is not required, depress and turn gas control knob clockwise back to 'OFF' position. 'MAIN' burner will extinguish.

Pilot and Flame Failure Option (PF-Models)

Lighting the Open Burners

These hobs are fitted with individual standing pilots for each open burner which allows main burners to be turned 'ON' - 'OFF' without having to manually re-light burner each time that it is turned 'ON', as burner will automatically light itself off pilot burner.

Flame Failure Protection is incorporated for each burner by way of a thermo-electric system which will shut off gas supply to that burner in the event that burner goes out, so that un-burnt gas is not expelled.

- a. Select burner required, depress and turn the corresponding gas control knob anti-clockwise to 'PILOT' position.
- b. With gas control knob depressed, manually light pilot burner.
- c. Release gas control knob approximately 10-20 seconds after lighting pilot burner.
- d. Pilot burner should stay alight - if not, repeat Steps (a to (c above.
- e. 'Full Flame' can now be achieved by depressing and rotating gas control knob anti-clockwise to 'HIGH' flame position.
- f. Low flame can be achieved by depressing gas control knob and rotating fully anti-clockwise to 'LOW' flame position.
- g. To achieve simmer control, depress gas control knob and rotate between 'HIGH' and 'LOW' positions to achieve temperature required.

Turning 'OFF' the Open Burners / Pilots

- a. To turn 'OFF' main burner, but keep pilot burner alight, rotate gas control knob to 'PILOT' position. Main burner will extinguish and pilot will remain alight.
- b. To turn 'OFF' the 'PILOT', depress and turn gas control knob clockwise back to 'OFF' position. 'PILOT' burner will extinguish.

Operation

Griddle



Caution

Griddle plate temperature reaches over 300°C in hottest points during normal operation at 'Full Flame' setting.

These griddles are fitted with a pilot as a standard option and Flame Failure Protection, which is incorporated by way of a thermo-electric system for each main burner. Flame Failure Protection will shut off gas supply to burner in the event that pilot for that burner goes out, so that un-burnt gas is not expelled. **This is an important safety feature which is slowly becoming law throughout the world.**

Lighting the Griddle

- a. Depress gas control knob and rotate anti-clockwise to 'PILOT' position.
- b. With gas control knob depressed, press piezo ignition button to ignite pilot burner. Repeat Items 1 to 2 until pilot is lit.
- c. Release gas control knob approximately 10-20 seconds after lighting pilot.
- d. Pilot should now remain alight - if not, repeat Steps (a to (c above.
- e. 'Full Flame' can now be achieved by depressing and rotating gas control knob anti-clockwise to first stop.
- f. Low flame can be achieved by depressing gas control knob and rotating fully anti-clockwise to 'Low Flame' position.
- g. When main burner is not required, depress and turn gas control knob clockwise to 'OFF' position.

Turning 'OFF' the Griddle Burner / Pilot

- a. To turn 'OFF' griddle, but keep pilot burner alight, rotate gas control knob to 'PILOT' position. Griddle burner will extinguish and pilot will remain alight.
- b. To turn 'OFF' the 'PILOT', depress and turn gas control knob clockwise back to 'OFF' position. 'PILOT' burner will extinguish.

Oven Pilot Ignition

! IMPORTANT DO NOT USE aluminium foil or trays directly on cast iron sole plate(s). NEVER block or cover openings on each side of sole plate(s).

1. Open oven door. Depress thermostat control knob and rotate anti-clockwise to 'PILOT' position.
2. With gas control knob depressed, press piezo ignition button to ignite pilot burner. Repeat Items 1 to 2 until pilot is lit.
3. Release gas control knob approximately 10-20 seconds after lighting pilot, until pilot thermocouple is heated up by pilot flame.
4. Pilot should now remain alight. If pilot does not light, repeat Items 1 to 3 above.
5. View pilot burner through holes in front of burner box with oven door open. See Fig 4.

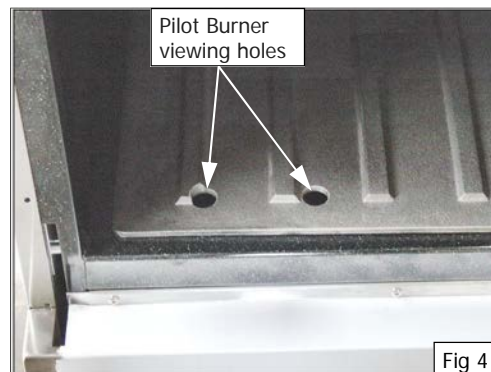

Oven - Main Burner / Thermostat

1. With pilot burner alight, rotate thermostat control knob anti-clockwise to desired oven temperature setting required, this will regulate gas supply to burner.
2. To turn main burner 'OFF', simply turn thermostat control knob clockwise to 'OFF' position.

Turning the Oven to 'Standby' (Pilot 'ON' Only)

1. To turn off oven burner / heating, set oven thermostat to 'PILOT' position, this will turn oven 'OFF', but leave oven pilot burner 'ON'.
2. In this position pilot burner will remain alight, but main burner will not operate until thermostat control knob is set to a temperature.
3. If pre-heating of oven is required, set thermostat control knob to temperature 190°C and allow 20 minutes before cooking in oven to allow oven to warm up.

Oven 'Shut-Down'

1. To turn oven to 'PILOT' position only, rotate thermostat control knob clockwise until pilot position is reached. In this position only pilot burner will remain on.
2. To 'Shut Down' oven, depress and turn thermostat control knob to 'OFF' position. This will turn 'OFF' oven and extinguish pilot burner. To re-light pilot burner, refer to 'Oven Pilot Ignition' in this section.

IMPORTANT:

Should any abnormal operation like;

- ignition problems,
- abnormal burner flame,
- burner control problems,
- partial or full loss of burner flame in normal operation, be noticed, appliance requires IMMEDIATE service by a qualified service person and should not be used until such service is carried out.

Cleaning and Maintenance

General



Caution

Always turn off the gas supply before cleaning.

This appliance is not water proof.

Do not use water jet spray to clean interior or exterior of this appliance.

Clean the range regularly. A clean range looks better, will last longer and will perform better. Carbonised grease on surface or between trivets, griddle plates will hinder transfer of heat from cooking surface to food. This will result in loss of cooking efficiency.

NOTE: Each griddle option can be supplied with a scraper tool and a pack of blades for cleaning griddle surface. These are not supplied with griddle and have to be purchased separately. Refer to 'Replacement Parts List' at rear of this manual.



Warning

THE BLADES FITTED TO THE SCRAPER TOOL ARE EXTREMELY SHARP AND ARE TO BE USED WITH CARE.

DO NOT use water on trivets, burners and griddle plates while these items are still hot as warping and cracking may occur. Allow these items to cool down and then remove for cleaning. The entire trivets, griddle plates and burner caps can be dismantled for cleaning.

NOTE:

- **DO NOT use abrasive detergents, strong solvents or caustic detergents as they could corrode or damage the range.**
- **In order to prevent rust forming on trivets, griddle plate (if fitted) and burners, ensure that any detergent or cleaning material has been completely removed after each cleaning. Appliance should be switched 'On' briefly to dry griddle plates. Spread oil or grease over griddle surface to form a thin protective greasy film.**

To keep your range clean and operating at peak efficiency, follow procedures shown below:-

After Each Use

1. Clean griddle with a scraper tool to remove any food debris.



Caution

Always ensure that even pressure is applied over whole surface of scraper tool when using on flat surface of griddle, to prevent scoring of griddle surface.

NEVER bang sharp edge of scraper tool on flat surface of griddle as this will damage griddle and invalidate the warranty.

2. Always ensure that scraper tool blades are changed regularly to ensure that scraper tool works efficiently and prevents damage to griddle plate surface.
3. Clean range castings with a stiff nylon brush or a flexible spatula to remove any food debris.

Daily Cleaning

1. Grease / spill trays should be checked and emptied frequently to prevent overflow and spillage. Remove grease drawer while still warm so that grease is in a liquid state. Empty any grease from drawer and wash thoroughly in same manner as any cooking utensil.
2. Remove burner caps and bases, trivets and thoroughly clean splash back, interior and exterior surfaces of range with hot water, a detergent solution and a soft scrubbing brush.
3. Brush griddle surface (optional - if fitted) with a soft bristled brush. Any carbon deposits should be removed using a scraper tool followed by wiping with a cloth to prevent build up of food deposits.
4. Dry range thoroughly with a dry cloth and polish with a soft dry cloth.

Weekly Cleaning

NOTE:

- If range usage is very high, we recommend that weekly cleaning procedure is carried out more frequently.
- Ensure that protective gloves are worn during cleaning.
- DO NOT use harsh abrasive detergents, strong solvents or caustic detergents as they will damage range, burners and plates.
- DO NOT use water on trivets, griddle plates and burners while they are still hot as cracking may occur. Allow these items to cool and then remove for cleaning.
- DO NOT clean burners in a dishwasher.

Range Cooking Area

- a. Clean range cooking area with a soft cloth moistened in a mild detergent and hot water solution.
- b. Baked on deposits or discolouration may need a good quality stainless steel cleaner or stainless steel wool. Always apply cleaner when appliance is cold and rub in direction of grain.
- c. It should not be necessary to remove splash guards covering burner manifolds for cleaning purposes. These can be cleaned in situ.
- d. Remove grease tray and clean with a mild anti bacterial detergent and hot water solution using a soft bristled brush. Clean control panel with a damp cloth moistened with a solution of mild detergent and water.
- e. Dry grease tray thoroughly with a dry cloth.

Griddle Plate - (Steel)



Caution

Always ensure that an even pressure is applied over whole surface of scraper tool when using on flat surface of griddle, to prevent scoring of griddle surface.

NEVER bang sharp edge of scraper tool on flat surface of griddle as this will damage griddle and invalidate the warranty.

NOTE: To prevent rust forming on griddle plate, ensure detergent or cleaning material has been entirely removed after each cleaning process. Appliance should be switched on briefly to ensure griddle plates are dry. Spread oil or grease over griddle surface to form a thin protective greasy film.

- a. Remove and clean grease / spill trays frequently to prevent over spills.
- b. Clean griddle surface thoroughly with optional scraper tool or a wire brush. Use a griddle stone or a scotch bright pad on griddle surface to remove stubborn or accumulated carbon deposits.
- c. A scraper tool can be used to remove stubborn carbon and deposits.
- d. Occasionally bleach griddle plate with vinegar when plate is cold.
- e. Clean with hot water, a mild detergent solution and a scrubbing brush. Dry all components thoroughly with a dry cloth.
- f. Switch griddle 'On' briefly to ensure that griddle plate is dry. Spread a thin smear of cooking oil over griddle to form a protective film.

Cleaning and Maintenance

Trivets and Burners

- Remove trivets from top of appliance, taking note that trivets are manufactured with a lip on one edge, lip must always be fitted to outer edge (front and back) of range. (See Fig 10).
- Remove burner cap and burner bowl (these are a loose fit to manifold, see Fig 5) from top of gas manifold, taking care not to damage thermocouple (and pilot tube - PF Option) fitted through manifold splash guard. (Refer to Fig 8 for 'F' Option and Fig 9 for 'PF' Option).
- Trivets and burners should be cleaned with a mild detergent and hot water solution using a soft bristled brush. Dry thoroughly with a dry cloth.

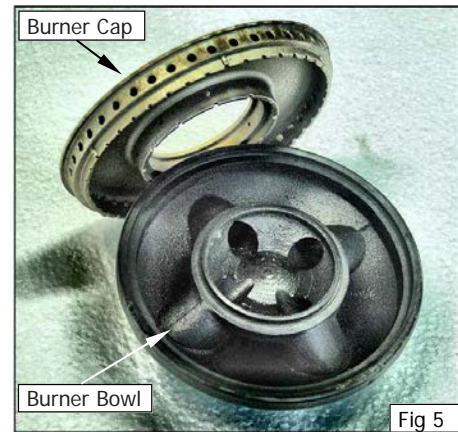

Trivet Supports

- Remove all trivet supports from top of appliance. Note orientation of trivet support when removing. Trivet support front end side rail profiles are different from rear end side rail profiles. (See Note shown at Item a, in 'Re-Fitting the Components to the Range' on following page and Fig 6).
- Trivet supports should be cleaned with a mild detergent and hot water solution using a soft bristled brush.
- Dry trivet supports thoroughly with a dry cloth.

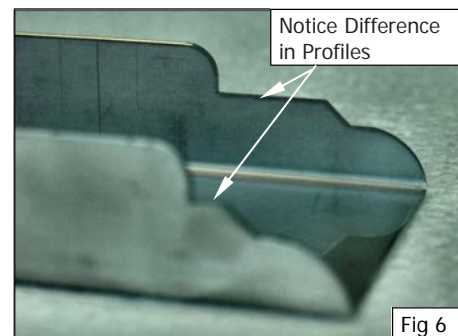

Stainless Steel Surfaces

- With griddle plates and burners removed, clean interior and exterior surfaces of range with hot water, a mild detergent solution and a soft scrubbing brush. Note that gas control knobs are a push fit onto gas control valve spindles and can be removed to allow cleaning of front control panel.
- Baked on deposits or discolouration may require a good quality stainless steel cleaner or stainless steel wool. Always apply cleaner when appliance is cold and rub in direction of grain.
- It should not be necessary to remove splash guards covering burner manifolds for cleaning purposes. These can be cleaned in situ.
- Dry all components thoroughly with a dry cloth and polish with a soft dry cloth.
- To remove any discolouration, use an approved stainless steel cleaner or stainless steel wool. Always rub in direction of grain.
- Remove grease tray and clean with a mild anti bacterial detergent and hot water solution using a soft bristled brush.
- Dry grease tray thoroughly with a dry cloth.
- Dry all components thoroughly with a dry cloth and polish with a soft dry cloth.

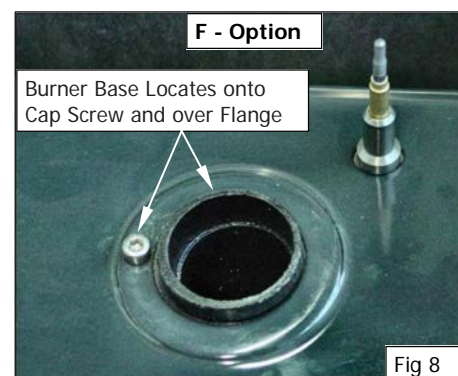
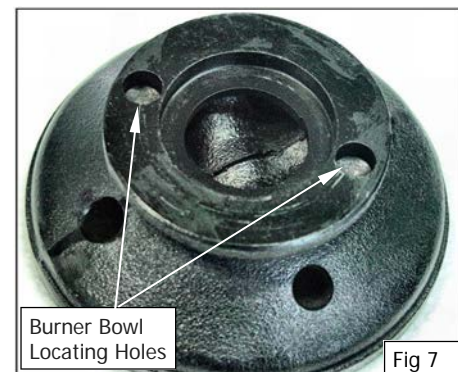

Re-Fitting the Components to the Range

- Refit trivet supports to range, ensuring that these are correctly fitted.

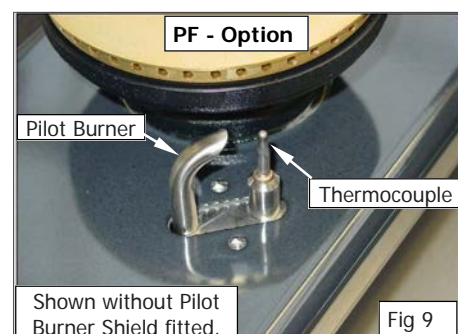

NOTE: It is imperative that trivet supports are correctly re-fitted to appliance to ensure that trivets locate correctly and sit flush and level. NOTE that trivet support front end side rail profiles are different at either side (Refer to Fig 6) and only one of side rails seat into cut-out in range, whereas rear end of trivet support side rail profiles are the same and have 2 locating cut-outs.

- b. Refit burner bowl onto manifolds protruding through splash guards, taking care not to damage thermocouple (and pilot tube - PF Option) which is close to manifold.

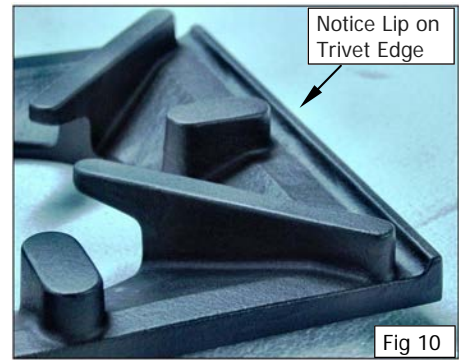

NOTE: Burner bowl (cast item) has 2 locating holes drilled into base flange (See Fig 7) these are to locate burner bowl onto cap screw on gas manifold when re-fitting burner bowl onto gas manifold (Refer to Fig 8 {F-Option} and Fig 9 {PF-Option}).

- c. Refit burner caps (cast brass) onto burner bowls already fitted to manifold. Burner cap is a loose fit into burner bowl.
- d. Refit trivets to cook top, taking note that trivets are manufactured with a lip on one edge, lip must always be fitted to outer edge (front and back) of range. (See Fig 10).
- e. Refit grease / spill tray(s) to range.

Oven Interior

- a. Do not use wire brushes, steel wool or other abrasive materials to clean oven interior.
- b. Clean oven regularly with a good quality domestic oven cleaner.
- c. Weekly, remove and clean any built up of grease etc. from oven racks and bottom spill cover.
- d. Dry oven thoroughly with a dry cloth and polish with a soft dry cloth.

Periodic Maintenance

NOTE: All maintenance operations should only be carried out by a qualified service person.

To achieve the best results, cleaning must be regular and thorough and all controls and mechanical parts should be checked and adjusted periodically by a qualified service person. If any small faults occur, attend to them promptly. Don't wait until they cause a complete breakdown. It is recommended that the appliance is serviced every 6 months.

Gas Control Valve Re-Greasing

Gas control valve should be dismantled and greased every 6 months to ensure correct operation.

To carry out this operation;-

- a. Remove gas control knobs from gas tap spindles by pulling knobs away from control panel.
- b. Remove drip tray from appliance.
- c. Remove two screws on underside of control panel, securing control panel to hob.
- d. Remove control panel from front of appliance.
- e. Remove 2 screws holding shaft plate to gas control body and remove control shaft and plate. (See Fig 11). Note orientation of shaft for re-assembly.
- f. Using needle nose pliers or similar, pull out gas control spindle, again noting its orientation.
- g. Apply a suitable high temperature gas cock grease or lubricant such as ROCOL - A.S.P (Anti scuffing paste) / Dry Moly Paste to outside of spindle. (See Fig 12).
- h. Replace spindle and re-assemble gas control in reverse order.
- i. Refit control panel to appliance and secure with 2 screws.
- j. Refit knobs to gas control valve spindles.

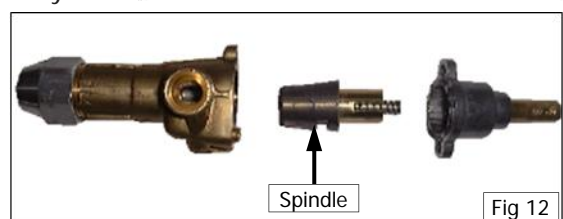
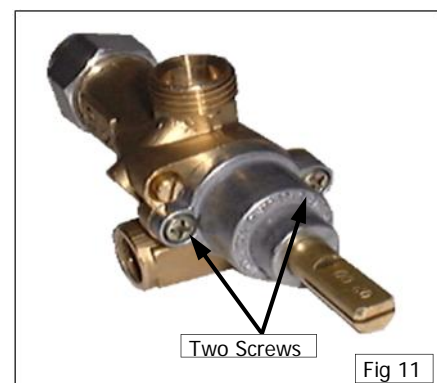

Fault Finding

This section provides an easy reference guide to the more common problems that may occur during the operation of your appliance. The fault finding guide in this section is intended to help you correct, or at least accurately diagnose problems with your equipment.

Although this section covers the most common problems reported, you may encounter a problem not covered in this section. In such instances, please contact your local authorised service agent who will make every effort to help you identify and resolve the problem. Please note that the service agent will require the following information:-

- **Model Trade Name and Serial Number of Appliance. (both can be found on Technical Data Plate located on appliance.**

Fault	Possible Cause	Remedy
Pilot won't light.	No gas supply. Blocked pilot injector.	Ensure gas isolation valve is turned on, and that bottles are not empty. Call service provider.
Pilot goes out when gas control knob released.	Releasing knob before thermocouple has heated. Pilot flame too small. - Gas pressure too low. - Partially blocked pilot injector. Thermocouple connection to gas control is loose or faulty. Thermocouple faulty. Electromagnet in rear of gas control unit is faulty.	Hold knob in for at least 20 seconds following ignition of pilot. Clean or replace pilot injector. Tighten thermocouple connection. Check thermo couple is producing between 20-30mV. Inspect and replace if not in good working order. Call service provider.
Main burner will not light.	Incorrect supply pressure. Faulty gas control.	Call service provider. Call service provider.
Piezo Ignition spark is being generated but not sparking from ignition electrode to pilot burner hood. (Griddle Option Only)	HT lead damaged or broken. Check ignition electrode is not cracked and is correctly positioned. Piezo igniter faulty.	Repair or replace HT lead. Re-position or replace ignition electrode. Replace piezo igniter. Call service provider.

NOTE: Components having adjustments protected (e.g. paint sealed) by the manufacturer, are only to be adjusted by an authorised service agent. They are not to be adjusted by an unauthorised service person.

Conversion Procedure



Caution

Ensure that the Appliance is isolated from the gas supply before commencing servicing.

NOTE:

- These conversions should only be carried out by qualified persons. All connections must be checked for leaks before re-commissioning the appliance.
- Adjustment of components that have adjustments / settings sealed (e.g. paint sealed) can only be adjusted in accordance with the following instructions and shall be re-sealed before re-commissioning this appliance.
- For relevant gas specifications refer to 'Gas Specifications Tables' at end of this section.

Open Burners.

1. Remove the following:-

- Trivets burner caps and burner bowls. Take care not to damage thermocouples.
- Trivet supports, (*pilot shields - PF options only*), splash guards.

2. Remove injectors and replace with correct size injectors as shown in 'Gas Specifications Tables' at end of this section.

- **For F Options Only**, unscrew and remove main injectors.

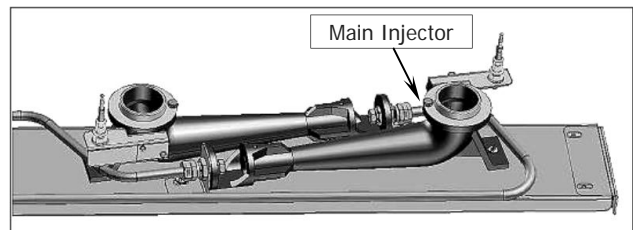

- **For PF Options Only**, unscrew and remove main injectors and pilot injectors.

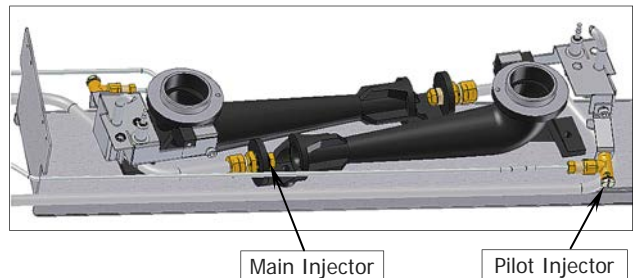

3. Refit the following:-

- Splash guards, (*pilot shields - PF options only*).
- Trivet supports, trivets, burner caps and burner bowls.

4. Re-light main burners and check flame size on simmer (LOW) position.

- **Adjust low fire adjustment screw on open burner gas control valves to obtain desired flame size.**

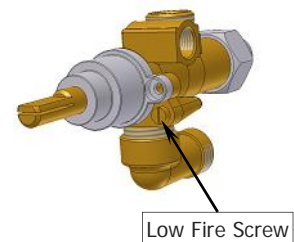

NOTE: The 'Low Fire Screw' should be sealed with coloured paint on completion of low fire adjustment.

Gas Conversion and Specifications

Griddle

1. Carry out the following:-
 - Remove griddle plate section and heat shield.
 - Remove main burner.
 - Disconnect piezo igniter from mounting bracket. (For access purposes).
 - Disconnect pilot supply tube from pilot burner to access pilot injector.
2. With Main Burner removed, ensure aeration gap is adjusted for type of gas being used as shown in 'Gas Specifications Tables' at end of this section.
3. Remove pilot and main injectors and replace with correct size injectors as shown in 'Gas Specifications Tables' at end of this section.
4. Refit the following:-
 - Re-connect pilot supply tube to pilot burner.
 - Re-connect piezo igniter to mounting bracket.
 - Refit main burner, gas control heat shield and griddle plate to cooktop.
5. Re-light main burners and check flame size on 'Low' flame position.
 - **Adjust low fire adjustment screw on open burner gas control valves to obtain desired flame size.**

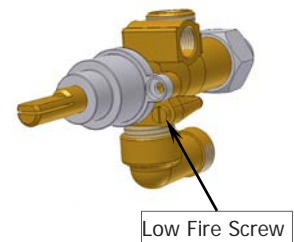
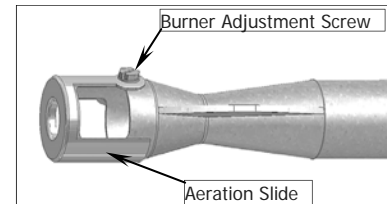
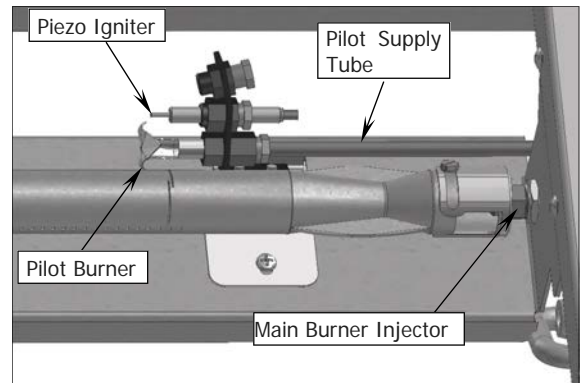

NOTE: The 'Low Fire Screw' should be sealed with coloured paint on completion of low fire adjustment.

Static Oven

1. Carry out the following:-
 - Remove lower lintel at front of oven.
 - Open oven door and remove sole plate(s).
 - Remove main burner.
 - Disconnect pilot supply tube from pilot burner to access pilot injector.
2. With Main Burner removed, ensure aeration gap is adjusted for type of gas being used as shown in 'Gas Specifications Tables' at end of this section.

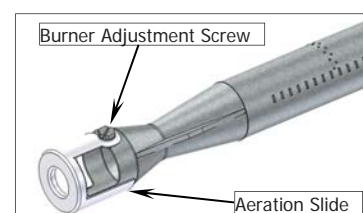
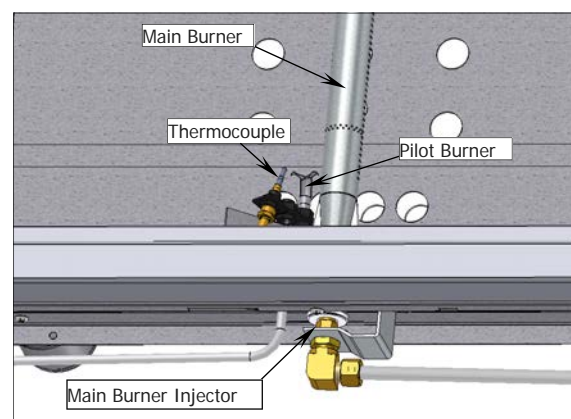

Gas Conversion and Specifications

1. Remove pilot and main injectors and replace with correct size injectors as shown in 'Gas Specifications Tables' at end of this section.
2. Refit the following:-
 - Re-connect pilot supply tube to pilot burner.
 - Refit main burner and sole plate(s).
 - Refit lower lintel.
3. To replace the low fire screw in the static oven gas valve:-
 - Remove the oven control panel.
 - Remove low fire screw from gas valve and replace with correct size low fire screw as shown in 'Gas Specifications Tables' at end of this section.

NOTE: The 'Low Fire Screw' should be sealed with coloured paint on completion of low fire adjustment.

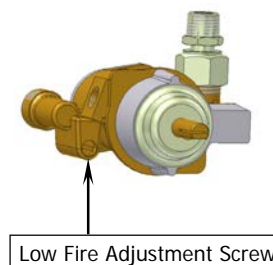

- Refit the oven control panel.

Gas Regulator

NOTE: The gas regulator supplied is convertible between Natural Gas and LP Gas, but its outlet pressure is fixed ex-factory and is NOT to be adjusted.

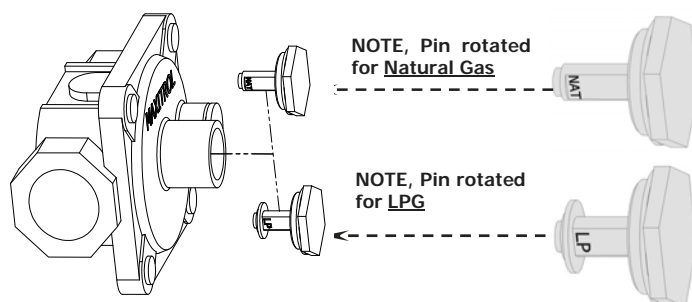

Gas Type Identification Label

1. On completion of gas conversion, replace gas type identification label located at:-
 - Rear of appliance, above gas connection.
 - Beside the rating plate.

Commissioning

1. Before leaving the installation;
2. Check all gas connections for leakage using soapy water or other gas detecting equipment.



Warning



DO NOT USE A NAKED FLAME TO CHECK FOR GAS LEAKAGES.

3. Carry out a 'Commissioning' check of the appliance as shown in the Installation Section of this manual.
4. Ensure any adjustments done to components that have adjustments / settings paint sealed are to be re-sealed.

Gas Conversion and Specifications

Gas Specifications

- Australia / New Zealand Only:



		Natural Gas (G20)	Propane (G31)
Open Burners	Main Burner Injectors	Ø 2.45 mm	Ø 1.50 mm
	Pilot Burner ('PF' Option Only)	0.30	0.20
Griddle	Main Burner	Ø 2.10 mm	Ø 1.30 mm
	Pilot Burner	0.35	0.23
Oven	Main Burner	Ø 2.40 mm	Ø 1.40 mm
	Pilot Burner	0.35	0.23
	Low Fire	0.90 mm	0.55 mm
	Burner Aeration Setting	Fully Open	10 mm
Supply Pressure		1.13 - 3.40 kPa	2.75 - 4.50 kPa
Operating Pressure		0.95 kPa (*)	2.6 kPa (*)
Gas Regulator Cap Screw			

- UK Only:

Appliance Classification

Category: I1_{2H3P} (20, 30 / 37).

Flue Type: A₁.

		Natural Gas (G20)	Propane (G31)
Open Burner	Main Burner Injectors	Ø 2.30 mm	Ø 1.40 mm
	Pilot Burner ('PF' Models Only)	0.30	0.20
Griddle	Main Burner	Ø 2.10 mm	Ø 1.30 mm
	Pilot Burner	0.35	0.23
Oven	Main Burner	Ø 2.40 mm	Ø 1.40 mm
	Pilot Burner	0.35	0.23
	Low Fire	Ø 0.90 mm	Ø 0.55 mm
	Burner Aeration Setting	Fully open	10 mm
Supply Pressure		20 mbar	30 / 37 mbar
Operating Pressure		9.5 mbar (*)	26 mbar (*)
Gas Regulator Cap Screw			

* - Measure burner operating pressure at manifold test point with two burners operating at full setting. Operating pressure is ex-factory set, through the appliance regulator and is not to be adjusted, apart from when carrying out Gas Conversion, if required. (Refer to 'Gas Conversion' section for details).

Replacement Parts List

IMPORTANT:

Only genuine authorized replacement parts should be used for servicing and repair of this appliance. Instructions supplied with parts should be followed when replacing components.

For further information and servicing instructions, contact your nearest authorized service branch (contact details are as shown on reverse of front cover of this manual).

When ordering replacement parts, please quote part number and description as listed below. If part required is not listed below, request part by description and quote model number and serial number which is shown on rating plate.

Cook Top

Open Burners

227018	Burner Bowl.		
227017	Burner Cap.		
030245	Injector	(Nat. Gas)	Ø 2.45 mm.
030150	Injector	(LP Gas [Propane])	Ø 1.50 mm.
030230	Injector	(Natural Gas - G20)	Ø 2.30 mm (UK Only).
030140	Injector	(Propane - G31)	Ø 1.40 mm (UK Only).
026134	Pilot Injector	(Nat Gas)	0.30.
026136	Pilot Injector	(LP Gas [Propane])	0.20.
229442	Pilot Bracket Assembly.		
229444	Pilot Burner Shield.		
227405	Gas Control Valve	(with Flame Failure).	
227403	Gas Control Valve	(with Pilot & Flame Failure).	
227967	Knob - Open Burner	(with Flame Failure).	
227384	Knob - Open Burner	(with Pilot & Flame Failure).	
228167	Thermocouple - 320 mm Front.		
228166	Thermocouple - 600 mm Rear.		

Griddle

014105	Burner.		
032210	Injector	(Nat. Gas)	Ø 2.10 mm.
032130	Injector	(LP Gas [Propane])	Ø 1.30 mm.
227403	Gas Control	(with Pilot & Flame Failure).	
227384	Knob - Griddle.		
019215K	Pilot Burner Kit.		
026488	Pilot Orifice	(Nat. Gas)	0.35.
019217	Pilot Orifice	(LP Gas [Propane])	0.23.
019428	Thermocouple.		
227508	Piezo Ignitor.		
228047	Piezo H.T. Lead.		
018744	Piezo Ignition Electrode.		
228288	Grease Tray	(Griddle Plates).	

Regulator

228531	Regulator (Natural Gas / LP Gas [Propane] Convertible) ¾" BSP F/F.
--------	--

Replacement Parts List

Oven

022446	Oven Burner.		
018691K	Oven Pilot Burner Kit.		
018682	Oven Thermocouple	(1500 mm).	
018743	Thermocouple Spacer.		
018744	Electrode.		
019407	HT Cable.		
032240	Oven Burner Injector	(Nat Gas)	Ø 2.40 mm.
032140	Oven Burner Injector	(LPG)	Ø 1.40 mm.
026488	Pilot Injector	(Nat. Gas)	0.35.
019217	Pilot Injector	(LPG)	0.23.
228705	Pintossi Gas Control Kit.		
230118	Low Fire Screw	(Nat. Gas)	Ø 0.90 mm.
228963	Low Fire Screw	(LPG)	Ø 0.55 mm.
227508	Piezo Ignitor.		
230370	Knob Oven - (130 - 270°C).		
228704	Door Spring Kit	(Includes 2 Springs).	

General

227015	Pot Stand / Trivet.		
228882	Spill Tray 600 mm	(RN8410G / RN8820G Series).	
227850	Adjustable Leg	(150 mm).	
229674	Rear Roller Assy.		

Gas Conversion Kits

Models	Gas Type to Convert to			
	Australia / New Zealand Only		UK Only	
	Nat. Gas	LPG	Nat. Gas	LPG
RN8410GxF	231939	231938	231923	231922
RN8820GxF	231941	231940	231927	231926
RN8410GxPF	231943	231942	231931	231930
RN8820GxPF	231945	231944	231935	231934

Accessories

228566	Griddle Scraper Tool.
228567	Smooth Plate Scraper Blades (Pack of 5 blades).
228796	600 mm Plinth Kit.
228804	1200 mm Plinth Kit.

